

CAMBRO®



product catalog
www.cambro.com

2014/15

Cambro® Catalog Table of Contents

equipment



FOOD HOLDING & TRANSPORTATION

6-32

Insulated Beverage Containers	8-10
Beverage Service Cart	11
Insulated Food Servers (Non-Electric)	12-19
Camchiller®, Thermobarrier® & Camwarmer®	14
Temperature Maintenance	15
Transporter Capacity Guide	20
Insulated Food Servers (Electric)	21-31
Tablotherm	32



WAREWASHING, HANDLING & STORAGE

53-78

Camrack® 4-in-1 System	54-66
Personalization	67
Camdollies®	69-71
Tray & Dish/Silver Cart	72
S-Series Adjustable Dish Caddy	73
Dish Caddies	74-75
Cambox® Bus Boxes	76
KD Service Cart & KD Utility Cart	77
Service Carts	78
Sizing & Reference Guide	249-250



ELEMENTS SERIES

97-109

Camshelving Elements Series	97-105
Mobile Units	106-108
Divider Bars	108
Wall Shelves & Extenders	109

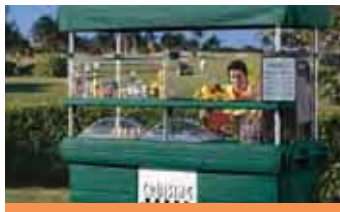

MOBILE VENDING

33-52

Versa Food Service System	34-36
Food Bars Accessories	37
Table Top Food Bars	38
Sample Food Bar Set-ups	39
CamKiosk® System	40-42
Camcruiser® Vending Carts	43-44
Booster Seats	45
Versa Organizers	45
Portable CamBars®	46-51
Ice Caddies	52



CAMSHELVING®

80-96

Camshelving®	80-89
Mobile Units	90-91
High Density Storage System	92-93
Security Cage	94
Wrap-around Security Cage	94
Divider Bars	95
Tray Slide Rack	95
Drying Rack System	96



BASICS SERIES

110-117

Camshelving Basics Series	110-113
Stationary Post Kits	114
Stationary Shelf Kits	114
Vented 4-Shelf Stationary Starter Units	115
Vented 4-Shelf Add-On Unit	115
Accessories	115
Dunnage Racks	117

supplies



FOOD STORAGE AND PREPARATION

118-148

Quick Guide To Storage Solutions	120-121
Food Storage Containers	122-129
Food Storage Boxes & Lids	130-133
Camwear® Food Pans & Lids	134-137
H-Pans™	138-141
Translucent Food Pans	142-143
ColdFest®	144
StoreSafe® Labels	145
Pizza Dough Boxes	146
Ingredient Bins & Camcrisper	147
Scoops & Measuring Cups	148



FOOD PRESENTATION

165-175

Deli Crocks & Platters	166
ShowFest® Display Bowls & Trays	167
Serving Bowls	168-170
Display Covers & Trays	171
Crocks & Ladles	172
Serving Spoons, Camtensils® & Turners	173
Tongs	174
Shakers/Dredges & Condiment Jars	175

healthcare



HEALTHCARE

220-237

Meal Delivery Ware	224-225
Camshelving® Drying Rack System	226
Camshelving Dome Drying and Storage Rack	226
Disposable CamLids®	227
Versa Trays	228-229
Non-Skid Versa Trays	230-231
Tablotherm	232-233
Meal Delivery Carts	234-237

GENERAL INFORMATION

Icon Directory	4
Warranty	5
Alpha Numeric Listing	238-248
Roto Color Chart	251

PERSONALIZATION

CamKiosk®	41
Camcruisers®	44
Camracks®	67
Table Service/Storage	154
Trays	183-184

www.cambro.com

Visit www.cambro.com for a wide variety of information about our products including new product updates, an interactive Camrack Glass to Rack Guide, consultant cut sheets and CAD drawings, care and maintenance product guides and more.



TABLE SERVICE

149-164

Dinnerware	150-151
Camcovers®	152-153
Personalization	154
Pitchers	155
Aliso® Barware	156
Tumblers	157-162
CamLid®	158
Camliter®	162
Beverage Dispenser, Pail With Bail & Swirl Bowls®	163
Wine Buckets, Punch Bowls & Bud Vase	164



TRAYS

176-219

Tray Product Guide	178-182
Personalization	183-184
Versa Trays	185-191
Versa Lite Trays	192-196
Camtrays®	197-202
Dietary & Camlite® Trays	203
Camtread® Trays	204
Treadlite™ & Polytread® Trays	205
Wood Trays	206-207
Corfu, Mykonos, Capri & Madeira Trays	208-212
Fast Food Trays	213
Compartment Trays	214-218
Polycarbonate Camwear Trays	219
Market Trays & Pans	219

The Trademarks of Cambro and product images are the property of Cambro and are subject to the control and ownership of Cambro. Any use thereof is only granted for the promotion and sales of Cambro products and subject to the control of Cambro Manufacturing Company.

The Cambro® Story

When William and Argyle Campbell first opened the doors at Cambro Manufacturing in 1951 their goal was to make a hospital meal tray of the highest quality possible. Named the Camtray®, it demonstrated that they were as committed to excellence in the food service industry as they were to the quality of their own products. As 2011 marks the company's 60th year of leadership in quality, innovation and customer service, today Cambro serves the world with the industry's most complete selection of products for widely diverse segments of the food service business.

Since 1951, the company has experienced many changes including a greatly expanded product line, new methods of manufacturing and distribution, and an increased emphasis on issues like environmental responsibility. From a single factory in California, Cambro has grown to become an international presence with production facilities and sales offices in the United States, Europe, the Middle East and Asia. But the original guiding vision of the Campbell brothers remains unchanged: to create and provide the most innovative, durable and highest quality products for the food service industry. Now led by William's son Argyle, Cambro is still dedicated to meeting our customers' needs, and equally committed to helping you serve, satisfy and delight your guests.

At the heart of our business philosophy is our willingness to listen, so in a very real way we owe all our success to you, our customer. Our longevity in a very competitive field for 60 years certainly proves the value of that philosophy, and we are proud to have earned the loyalty of customers of all sizes and in all segments of the industry. From hotels to healthcare to caterers, from restaurant chains to educational facilities, we understand the food service business and we design and create our products with the end user foremost in mind. Our goal is to provide our customers the best

possible value on products that are durable, save labor and increase food safety, so you can offer your guests a superior experience while enhancing profitability.

Cambro is uniquely committed to investing in the people and processes that make our products a reality. We're proud that children and grandchildren of some of our first employees are with us today, and of the dedication to quality and service of our entire family worldwide. We continually work on developing new ideas for specific industry segments, and invest in new tooling and leading-edge machinery to bring these products to market. We persistently strive to improve our manufacturing methods to be more efficient in terms of process and materials, to keep costs under control while keeping our planet healthy. And we constantly seek to maintain quality and value despite rising costs of transport and raw materials, the need to reduce environmental impacts, and the demand of end users for total order accuracy and responsive service across a global market.

From once offering a single product, the Camtray, sixty years ago, today Cambro offers a wide range of trays, table service and display items, storage, shelving, merchandising and insulated transport products, as well as innovative warewashing systems and healthcare meal delivery solutions.

The future is certain to bring great changes to our industry. Yet one thing that will remain a constant is Cambro's tradition of continually developing new products that help food service operators save time and money, increase sales, reduce labor and improve service. In the years ahead, guided by the commitment of its founders to innovation, quality, and value, Cambro Manufacturing will still be the leader in serving the food service industry and you, our valued customer.



Cambro Warranty

- 5 year pro-rated warranty against damage or defects found in excess to normal wear and tear on
 - Camtrays®
 - Camtread Trays®
- 5 year warranty against breakage in excess to normal wear and tear
 - Versa Trays
 - Dinnerware
- 2 year warranty against breakage under normal use
 - Polycarbonate food storage pans
 - Polycarbonate Squares
 - Polycarbonate Rounds
 - Polycarbonate Lids
- 1 year warranty on
 - Commercial Electric Equipment models
- 1 year warranty on workmanship and Lifetime Limited warranty against rust and corrosion, excluding mobile posts.
 - Camshelving®
 - Camshelving Elements Series

For all other Cambro products, Cambro warrants to the original buyer a three-year pro-rated warranty. If product proves defective during this time, Cambro grants a pro-rated credit of the original price toward replacement product. The warranty applies on all Cambro products only when used under normal foodservice industry conditions.

Specifications, features and equipment shown are based upon the latest information available. Cambro Manufacturing Company reserves the right to make changes at any time, without notice, to price, colors, specifications, accessories and materials. For additional information, please contact your authorized Cambro representative.

Note: Temperature ranges noted throughout this catalog are based on specific test criteria and provide a general guideline. Individual use may vary due to differences in loading temperatures or ambient temperature.

Product Accessories: Contents and accessories shown in photos are not included, except where noted.

ICON DIRECTORY

Throughout the Cambro catalog, find the following easy to identify icons to help explain Cambro product features or services.



Food Safety Matters

For 60+ years, Cambro foodservice equipment and supplies have earned the trust and loyalty of customers and public health professionals alike because our products are designed with Food Safety in mind. At Cambro, every product design is based upon the core principle of food safety.

Look for the Cambro StoreSafe mark throughout the Cambro catalog to identify Cambro storage and transportation products that help ensure food safety handling.

You can learn more about Cambro's Food Safety initiatives at www.cambro.com/storesafe



Many Cambro products may be recycled. For further information, please contact your Cambro representative.



Cambro "Storage Select" BPA-Free (Bisphenol-A Free) products are available for customers who are interested in products deemed BPA-Free. Please contact your sales representative for more information.



Listed by NSF International, an independent, not-for-profit organization which certifies products that meet their criteria for sanitation and cleanability.



Not For Use In Heated Carts



Fit for Food Products



Dishwasher Safe



Stackable



Foam Insulation



Prorated Warranty

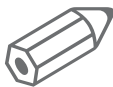

Personalization Available
Non-Food Contact Areas Only



One carton of product is within the weight and cube requirements to be shipped by parcel carrier.



New Product



CAMBRO equipment

Food Holding & Transportation / Mobile Vending Equipment

Warewashing, Handling & Storage / Camshelving®

Camshelving Elements Series / Camshelving Basics Series



Food Holding And Transportation



- Insulated Beverage Containers
- Beverage Service Carts
- Insulated Top Loading Camcarriers®
- Temperature Maintenance Tools
- Insulated Front Loading 300MPC & UPC400
- UPCS400 Ultra Pan Carrier® S-Series
- Ultra Camcarts®
- Transporter Capacity Guide
- Ultra Pan Carrier® and Ultra Camcart® H-Series
- Combo Cart™ Plus
- Camtherm® Electric Food Holding Cabinets
- Insulated Bakery Container
- Camcarts®
- Camcarriers®
- Tablotherm Insulated Trays

Insulated Beverage Containers



- Use to hold, transport and serve hot or cold beverages.
- One piece, seamless double-wall polyethylene with thick foam insulation.
- Sturdy latches secure lids tightly and will never rust.
- Drip-proof recessed spigot for easy self-serve access.
- Stack units on riser to fill large cups or coffee pots.
- Sta-stack interlocking ensures stable stacking during transport and storage.

Easy Serve Dispenser Color: Black (110).
 UC250 and UC500 covered by U.S. Patent D 403,917. UC1000 covered by U.S. Patent D 403,916.

Vent Cap patent pending.



350LCD Camtainer not NSF.

Durable and attractive covers extend the life of your Camtainers and fit in any serving environment.

Personalization available. Contact your Cambro representative for details. (Models for covers on next page.)



Vent Cap

Equalizes pressure. Makes the opening of the container much easier.

E-Z Grip Molded-in Handles

For comfortable, safe transporting.



Recessed Faucet

Accommodates larger cups. Allows even dispensing and eliminates drips. Two positions: One for continuous pouring and one for individual dispensing.



Molded-in Metal Backing Plates

Prevents latches from breaking away from the container.



Ultra Camtainers®

Feature wide nylon latches which are easy to open and close with one hand.



Camtainers®

Feature sturdy plastic latches that secure lids tightly and will never rust.



Stack beverage servers during storage and transporting to save space.

Stacking options:

- 100LCD with 100LCD
- All 250, 350 and 500 units
- UC1000 and 1000LCD

Hot

250LCD	87°C	84,5°C	82°C	79°C	77°C
UC250	88°C	85,5°C	84°C	82°C	80°C
Starting Temperature	1 hr.	2 hrs.	3 hrs.	4 hrs.	

Cold

250LCD	1°C	1,5°C	2°C	3°C	4°C
UC250	0,5°C	1°C	1°C	1,5°C	2°C
Starting Temperature	1 hr.	2 hrs.	3 hrs.	4 hrs.	

Ultra Camtainers®

Choose from three sizes for beverage service. A contemporary line, featuring two wide nylon latches per unit that are easy to open and close.



CODE	UC250	UC500	UC1000
CAPACITY	10,4 L	19,9 L	39,7 L
210 ML. CUPS	50	96	192
EXTERIOR DIMENSIONS D x W x H	42,5 x 30 x 50 cm	42,5 x 30 x 68 cm	52 x 41,5 x 65,5 cm
FITS CAMDOLLY	CD100H, CD1826H, CD300H, CD100HB, CD300HB, CD100	CD100H, CD1826H, CD300H, CD100HB, CD300HB, CD100	CD300H, CD1826H, CD2020H, CD100HB, CD300HB, CD1826MTCHB, CD300, CD2020
CAMTAINER COVER	UC250CVR	UC500CVR	UC1000CVR

Case Pack: 1 Colors: Navy Blue (186), Slate Blue (401), Coffee Beige (157), Dark Brown (131), Brick Red (402), Green (519), Black (110), Granite Grey (191), Granite Green (192), Granite Sand (194). Venting plug is covered by US Patent D 553,717 S.

Camtainers®

The standard for many caterers, choose from four sizes for beverage service and one model without a spigot for soup service. Four sturdy plastic latches on each unit open and close easily and will never rust.



CODE	100LCD	250LCD	500LCD	1000LCD	350LCD (SOUP)
CAPACITY	5,7 L	9,5 L	17,9 L	44,5 L	12,7 L
210 ML. CUPS	27	45	85	214	60
SPIGOT	YES	YES	YES	YES	—
EXTERIOR DIMENSIONS D x W x H	29 x 26,5 x 44 cm	42 x 23 x 47 cm	42 x 23 x 62 cm	53 x 41,5 x 63 cm	42 x 23 x 47 cm
FITS CAMDOLLY	CD1420	CD100H, CD1826H, CD300H, CD2020H, CD100HB, CD300HB, CD1826HB CD2020HB, CD100, CD2020	CD100H, CD1826H, CD300H, CD2020H, CD100HB, CD300HB, CD1826HB CD2020HB, CD100, CD2020	CD300H, CD1826H, CD2020H, CD100HB, CD300HB, CD1826MTCHB, CD300, CD2020	CD100H, CD1826H, CD300H, CD2020H, CD100HB, CD300HB, CD1826HB CD2020HB, CD100, CD2020
CAMTAINER COVER	—	250LDCVCR	500LDCVCR	1000LDCVCR	—

Case Pack: 1 Colors: Navy Blue (186), Slate Blue (401), Coffee Beige (157), Dark Brown (131), Brick Red (402), Green (519), Black (110), Hot Red (158). Venting plug is covered by US Patent D 553,717 S.

Camserver® — Holds The Heat For Hours.

- A front-of-house beverage server for hot or cold beverages that does not require canned heating.
- Double-wall polyethylene shell with thick foam insulation retains temperatures for hours.

Colors: Black (110), Dark Taupe (417), Granite Grey (191).



Convenient top-fill opening for fast replenishment without removing lid.

CSR3 Shown in Dark Taupe Height is approximate 18 cm from counter to spigot.



CSR5 Shown in Black

CODE	EXTERNAL DIMENSIONS H x W x D	CAPACITY	210 ML CUPS	CASE PACK
CSR3	60 x 34 x 46,5 cm	11,5 L	54	1
CSR5	71 x 34 x 46,5 cm	19 L	91	1

Handwash Accessory — For Camtainers® & Ultra Camtainers®



- Set up a Handwashing Station quickly and easily on or off premise.
- Convenient and economical way to meet health department hand washing requirements.
- Attaches to Camtainers® 250LCD, 500LCD or Ultra Camtainers® UC250, UC500.
- Includes four Handwash Only labels and an Easy Serve Dispenser lever.

Handwash Accessory Stocking Colors: Dark Brown (131), Black (110).

Easy Serve Dispenser Color: Black (110).

Riser Colors: See optional accessories with Camtainers.

Pail with Bail Color: White (148).

Handwash Accessory is covered by the following U.S. Patent D 506,634 S & D 506,899 S.



CODE	HWAPR	HWATD
DESCRIPTION	With paper towel roll holder	With Multi-Fold Paper Towel Dispenser
FITS	250LCD, 500LCD, UC250, UC500	250LCD, 500LCD, UC250, UC500

Optional Accessories

CODE	DESCRIPTION
R500LCD	Riser
PWB22	Pail with Bail
LCDES	Easy Serve

Shown with 500LCD Camtainer®.

Optional Accessories



CODE	R500LCD	R1000LCD	LCDCH	LCDCH10	LCDES
DESCRIPTION	Riser	Riser	Condiment Holder	Condiment Holder	Easy Serve Dispenser
EXTERIOR DIMENSIONS	D x W x H 41,5 x 23 x 12 cm	D x W x H 49,5 x 39 x 11,5 cm	D x W x H 42 x 22 x 13 cm	D x W x H 51 x 41 x 12 cm	—
FITS	250LCD, 500LCD, UC250, UC500	1000LCD, UC1000	250LCD, 500LCD UC250, UC500	1000LCD, UC1000	LCD Spigots UC Spigots

Case Pack: 1 **Colors:** Slate Blue (401), Coffee Beige (157), Dark Brown (131), Black (110), Hot Red (158), Granite Grey (191). **Easy Serve Color:** Black (110)

Hydration Station

Cart with two 19 L beverage servers with covers can be used at full height with three shelves or at lower height with two shelves.



CODE	HYDRATIONPKG**
DESCRIPTION	1- KD Utility Cart, 2- 500LCD Beverage Servers, 2- Easy Serve Dispensers and 2- Black Personalized Beverage Server Covers stating "WATER"
DIMENSIONS* W x D x H	101,6 x 53,96 x 147,32 cm

Case Pack: 1 **Camtainer and Cover Color:** Black (110).

*Dimensions based on 3 shelf cart with Camtainers on top shelf.

**Ships in 7 separate cartons.

With 2-shelf set-up, approximate distance from floor to spigot is 60 cm; with 3-shelf set-up: 94 cm.

Beverage Service Carts



- Ideal for breakfast, coffee or snack service.
- Use top counter to hold Cambro Beverage Servers, Versa Organizer Bins or Display Trays with Covers for food.
- Store drinkware, additional food items or other supplies in open compartment.
- Insulated cabinets hold hot or cold food in full, 1/2 or 1/3 size food pans or on Cambro Metric Camtrays® (3253).

Colors: Slate Blue (401), Granite Grey (191), Granite Green (192).

See Organizer section for more information on Organizer Bins.

See Camtainer section for more information on Camtainers.

Wire Rack Color: Silver (000).

See Cold Pack section for more information on Cold Packs.

15,2 cm Casters: 2 fixed, 2 swivel, 1 with brake.

For complete specifications, call or write Cambro.



Beverage Service Cart is designed to hold Beverage Containers at point of service only. A dolly or hand truck with safety strap is recommended for moving Beverage Containers over longer distances or uneven surfaces.



MDC24F



MDC24 has recessed top that holds 3 each 3,8 Liters 100LCD Camtainers and stacked Condiment Bins & Wire Rack with 3253 trays.

CODE	EXTERIOR DIMENSIONS L x W x H	CASE PACK
MDC24	113 x 76 x 112 cm	1
MDC24F	113 x 76 x 112 cm	1
OPTIONAL ACCESSORIES		
Organizer Bin		
5412CBP	30,5 x 13 x 11 cm	12
Camtainer®		
100LCD	26,5 x 30 x 44 cm	1
Wire Rack		
MDC24R	58,4 x 43,2 x 35,5 cm	1
Camchiller®		
CP1220	53 x 33 x 3,8 cm	1

The use of racks in the MDC24 and MDC24F carts will allow the following configuration of pans or trays, per compartment:

DESCRIPTION	GN (1/2)	GN (1/3)	GN (1/4)
6,5 cm Pans	(4) 12CW	(8) 22CW	(12) 32CW
10 cm Pans	(3) 14CW	(6) 24CW	(9) 34CW
15 cm Pans	(2) 16CW	(4) 26CW	(6) 36CW
20 cm Pans	(1) 18CW**	(2) 28CW**	(3) 38CW**

** with room for 6,5 cm or 10 cm pan above 15 cm pan. 10 each 3253 Metric Camtrays®.

Compartment Dimensions

Shelf Compartment	W 96,5 cm	D 64 cm	H 25,4 cm
Holding Compartments	W 44,5 cm	D 60,3 cm	H 36 cm

Venting plug is covered by US Patent D 553,717 S.

MDC24R Wire Rack

Wire Rack (sold separately) to organize pans and trays in the cart. Rack holds Full, 1/2 and 1/4 size Food Pans and 3253 trays. When placed in cart's core area, the rack allows room on either side of pan positions for Cambro's CP1220 Camchillers® one on each side.



Insulated Top Loading Camcarriers® To Transport Gastronom Food Pans

- Top-loading food pan carriers hold, transport and serve a single full-size pan of hot or cold food.
- Sturdy and durable, seamless polyethylene or polypropylene with thick foam insulation.
- Molded-in handles on all four sides for easy carrying and handling.
- Use with divider bars to hold multiple fractional pans.
- Pans are easy to remove using finger notches.
- Carriers interlock and stack for transporting and storing.

UPCS Colors: Dark Brown (131), Speckled Grey (480), Coffee Beige (157), Black (110).

MPC and MPCHL Colors: Navy Blue (186), Slate Blue (401), Coffee Beige (157), Dark Brown (131), Brick Red (402), Green (519), Black (110), Hot Red (158).

* Polypropylene dough boxes are safe for use in high temperature dishwashers.

UPC Colors: Slate Blue (401), Coffee Beige (157), Dark Brown (131), Black (110), Granite Grey (191), Granite Green (192), Granite Sand (194).

Camdolly® Colors: Coffee Beige (157), Dark Brown (131), Black (110), Slate Blue (401), Grey (180).

Divider Bar Colors: White (148), Clear (135).

See Food Pan Section for pricing and ordering information.

Note: Place food pans on rails. Pans should not be placed on the floor of a Camcart or Camcarrier® cavity.

Note: Best results will be achieved by loading food pans between 82° to 88°C. Loading metal food pans over 121°C may result in damage to the carrier or cart.



UPC & MPC Models

UPCS160



Stacking and storage reduced by 35%!

UPCS140

UPCS180

UPCS160

UPC140

UPC160

Shown with dividers and fractional sized food pans.

No divider bars available for UPC100.

Hot

UPC160	87°C	85°C	83°C	81°C	79°C
UPCS160	87°C	85°C	83°C	81°C	79°C
UPCCS160	87°C	85°C	83°C	81°C	79°C

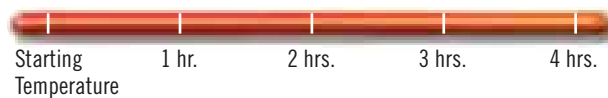

Cold

UPC160	0°C	1°C	2°C	2°C	2,5°C
UPCS160	0°C	1°C	2°C	2°C	2,5°C
UPCCS160	0°C	1°C	2°C	2°C	2,5°C



Camcarrier®

One-piece, seamless polyethylene construction, airtight removable gasket and sturdy plastic latches.



CODE	240MPC
COMPARTMENT CAPACITY	1 GN½ - 10 cm deep pan
EXTERIOR DIMENSIONS W x D x H	42 x 35 x 19 cm
Case Pack:	1

S-Series

Durable polypropylene construction, built in seal and wide, nylon latches. Contemporary appearance and superior holding performance at an economical price.



CODE	UPCS140	UPCS160**	UPCS180	UPCSS160*
COMPARTMENT CAPACITY	1 GN $\frac{1}{2}$ - 10 cm deep pan	1 GN $\frac{1}{2}$ - 15 cm deep pan	1 GN $\frac{1}{2}$ - 20 cm deep pan	1 full size 15 cm deep pan
EXTERIOR DIMENSIONS W x D x H	64 x 43,5 x 22 cm	64 x 43,5 x 26 cm	64 x 43,5 x 30,5 cm	62,5 x 42 x 28 cm
FITS CAMDOLLY®	CD160	CD160	CD160	CD160

Case Pack: 1 *UPCSS160 available in Dark Brown (131) and Coffee Beige (157). **UPCS160 Cannot be used with Camchiller.
Temperature Maintenance Tool for UPCSS160 Only: CP1220 and CP1210 Camchiller®

Ultra Pan

One-piece, seamless polyethylene construction, airtight removable gasket and wide, nylon latches.



CODE	UPC140	UPC160	UPC180
COMPARTMENT CAPACITY	1 GN $\frac{1}{2}$ - 10 cm deep pan	1 GN $\frac{1}{2}$ - 15 cm deep pan	1 GN $\frac{1}{2}$ - 20 cm deep pan
EXTERIOR DIMENSIONS W x D x H	63 x 44 x 21 cm	63 x 44 x 26 cm	63 x 44 x 30,5 cm
FITS CAMDOLLY	CD100H, CD1826HB, CD160	CD100H, CD1826HB, CD160	CD100H, CD1826HB, CD160

Case Pack: 1

100 Series

Store and stack food pans or place food directly in compartment. The 100MPCHL model has a hinged serving lid.



CODE	100MPC	100MPCHL	UPC100
COMPARTMENT CAPACITY	3 GN $\frac{1}{2}$ - 6,5 cm deep pan or 2 GN $\frac{1}{2}$ - 10 cm deep pans or 1 GN $\frac{1}{2}$ - 15 or 20 cm deep pan	1 GN $\frac{1}{2}$ - 20 cm deep pan	3 GN $\frac{1}{2}$ - 6,5 cm deep pans or 2 GN $\frac{1}{2}$ - 10 cm deep pans or 1 GN $\frac{1}{2}$ - 15 cm or 20 cm deep pan
EXTERIOR DIMENSIONS INTERIOR DIMENSIONS W x D x H	68 x 45 x 38 cm 55 x 35 x 20,5 cm	68 x 45 x 39,5 cm 55 x 35 x 20,5 cm	68 x 46 x 40 cm 56,5 x 33 x 20,5 cm
BULK CAPACITY*	38 L	38 L	38 L
FITS CAMDOLLY	CD100H, CD1826MTC, CD100HB, CD1826MTCHB, CD100, CD2028	CD100, CD100H, CD100HB	CD100H, CD1826MTC, CD100HB, CD1826MTCHB, CD100, CD2028

Case Pack: 1 * Without using food pans.

Accessories

CODE	OVERALL EXTERIOR DIMENSIONS	CASE PACK
Divider Bars		
DIV12	32,38 cm (Length)	3
DIV20	53,02 cm (Length)	3

*Not for use in UPCSS1600



Camchiller®, ThermoBarrier® & Camwarmer®



Camchiller



- An easy-to-use, cold food holding temperature tool.
- Extend cold holding time or enhance safe holding below 5°C when frequent access is required.
- Freeze first then use to pre-chill cabinet before loading.

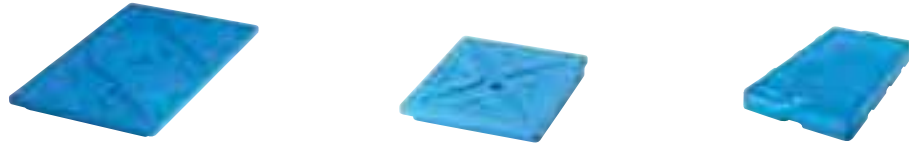
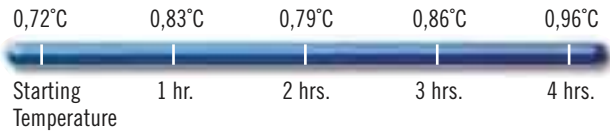

CODE	CP1220 (GN FULL SIZE)	CP1210 (GN HALF SIZE)	CP814 (20 x 36 CAMCHILLER)
FITS INTO	UPCSS160, 300MPC, 1318MTC, UPC400, UPC400TR, UPSC400, UPC600, UPC800, UPC800TR, UPC1200, UPC1600, CVC72, CVC724, CMB1826, CMB1826L, and CamKiosk®*	125MPC, 300MPC, 1318MTC, UPC400, UPSC400, UPC400TR, UPC600, UPC800, UPC800TR, CVC724*, CVC72* and CamKiosk*	12186CW, 12186P, 12189CW, 12189P, CVC724, CVC72, CVC55, and CamKiosk
DIMENSIONS L x W x H	53 x 33 x 3,8 cm	32,4 x 26,4 x 3,8 cm	35,56 x 20,32 x 3,8 cm
QUANTITY PER CAVITY	1 (*2 per cavity)	1 (*2 per top wells)	1

Case Pack: 1 Color: Cold Blue (159).

ThermoBarrier

- A highly valuable yet economical temperature maintenance tool for caterers.
- Use to minimize empty space and food temperature loss within a partially loaded compartment.

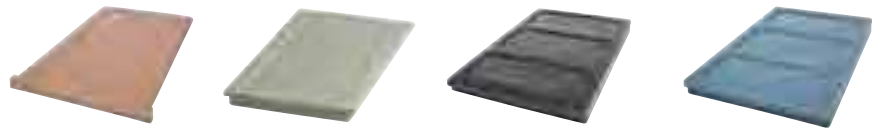

CODE	300DIV	400DIV	1200DIV	1600DIV
FITS INTO	300MPC, UPC600, 1318MTC	UPC400, UPC800, UPC400TR, UPSC400, UPC800TR	UPC1200, CVC72, CVC724	UPC1600, CamKiosk UPC1600TR
QUANTITY PER COMPARTMENT	1	1	2	2
DIM. L x W x H	53 x 33 x 2,5 cm	54 x 33 x 3,8 cm	53 x 33,5 x 3,5 cm	53 x 33,5 x 3,8 cm
COLOR	Coffee Beige (157)	Grey (180)	Dark Brown (131)	Slate Blue (401)
CASE PACK	1	1	2	2



Camwarmer

- Use for added insurance to keep hot foods hot during holding and transporting.
- Keep in cabinet with hot foods to extend holding time or enhance safe holding above 65°C when frequent access is required.



CODE	1210PW
FITS INTO	300MPC, 1318MTC, UPC400, UPC400TR, UPSC400, UPC600, UPC800, UPC800TR
DIMENSIONS L x W x H	34 x 27,5 x 4 cm
CASE PACK	1

UPC400 with Camwarmer. Two Camwarmers recommended per cavity.



Color: Granite Grey (191)

Temperature Maintenance – Optimize Food Holding Performance

Camchiller® – GN $\frac{1}{2}$ Size and GN $\frac{1}{2}$ Size

- Use to:
 - Pre-chill cabinet cavity.
 - Hold package food in food pan wells. (Half Size Only)
 - Maximize cold food holding.
 - Minimize open cavity space.
- Easy to use:
 1. Freeze 8 hours.
 2. Slide one or two on top rails and pre-chill cavity 15-20 minutes.
 3. Load in pans of pre-chilled food below Camchiller. (A)
 4. Move pans and Camchiller down as food is removed. (B)

COLD HOLDING

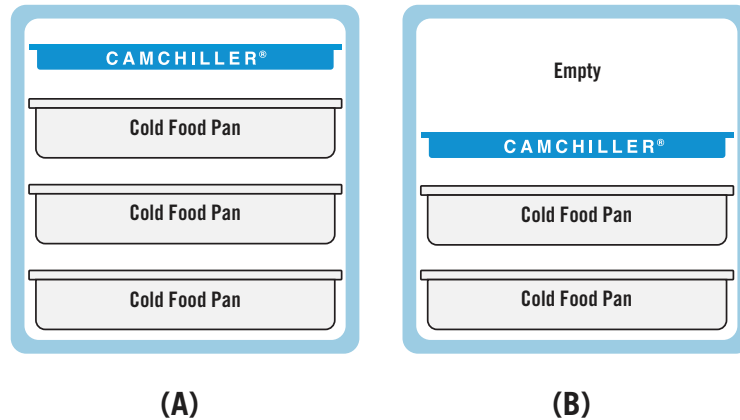

ThermoBarrier® – GN $\frac{1}{2}$ Size

- Use to:
 - Hold hot and cold food in same cabinet cavity.
 - Minimize open cavity space.
- Easy to use:
 1. Slide between hot food on top and cold food on bottom. (A)
 2. Slide under hot food loaded in upper cavity space. (B)
 3. Slide above cold food loaded into lower cavity space. (C)

HOT AND COLD HOLDING

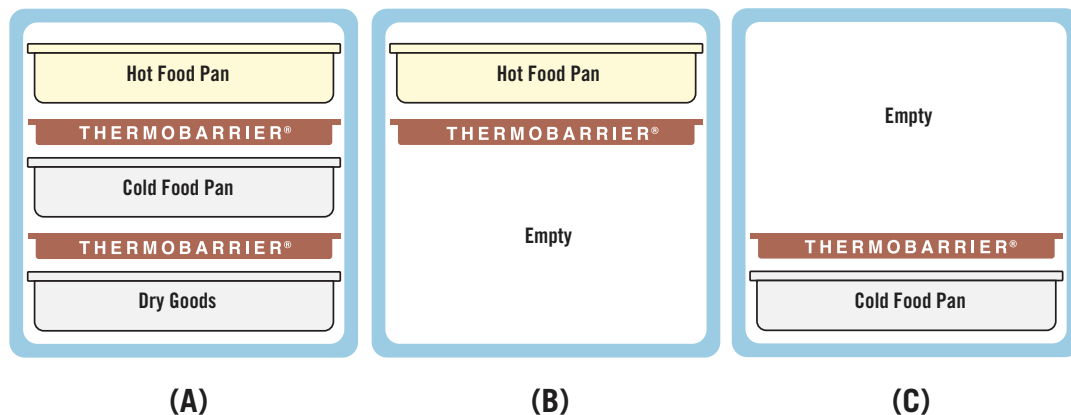

Camwarmer® – GN $\frac{1}{2}$ Size

- Use to:
 - Pre-heat cabinet cavity.
 - Maximize hot food holding.
 - Minimize open cavity space.
- Easy to use:
 1. Heat in 180°C oven for 45 minutes.
 2. Slide two Camwarmers on bottom rails and pre-heat cavity 15-20 minutes. (or place on high heat food pan lid or sheet pan)
 3. Load in pans of pre-heated food above Camwarmers. (A)
 4. Move pans and Camwarmers up as food is removed. (B)

HOT HOLDING

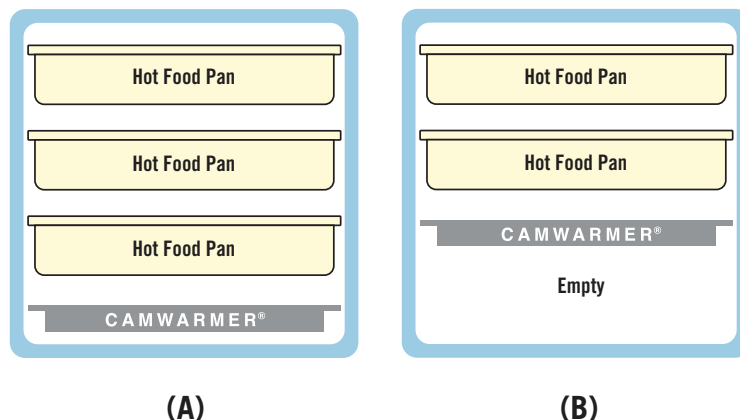

Insulated Front Loading 300MPC & UPC400 To Transport Gastronom Food Pans

- Durable and dependable front-loading food pan carriers.
- Hold multiple pans of hot or cold food at safe temperatures for hours.
- Seamless polyethylene with thick foam insulation.
- Airtight removable gasket provides a secure seal.

300MPC Colors: Navy Blue (186), Slate Blue (401), Coffee Beige (157), Dark Brown (131), Brick Red (402), Green (519), Black (110), Hot Red (158).

UPC400 Colors: Navy Blue (186), Slate Blue (401), Cold Blue (159), Coffee Beige (157), Dark Brown (131), Black (110), Granite Grey (191), Granite Green (192), Granite Sand (194).

▲ Camdolly Colors: Slate Blue (401), Coffee Beige (157), Dark Brown (131), Black (110), Grey (180).

Note: Place food pans on rails. Pans should not be placed on the floor of a Camcarrier® cavity. Please use specified food pan sizes.

Note: Best results will be achieved by loading food pans between 82° to 88°C. Loading metal food pans over 121°C may result in damage to the carrier or cart.

See Food Pan section for pricing and ordering information.

UPC400 is covered by US Patent D 392,158.

Venting plug is covered by US Patent D 553,717 S.



Hot

UPC400	87,8°C	85,6°C	84,5°C	82,8°C	81,7°C
--------	--------	--------	--------	--------	--------

300MPC	86°C	83°C	81°C	79°C	77°C
--------	------	------	------	------	------

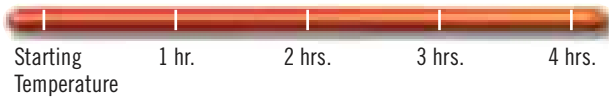

Cold

UPC400	0,3°C	0,8°C	0,9°C	1,2°C	1,4°C
--------	-------	-------	-------	-------	-------

300MPC	1°C	1,5°C	2°C	2,5°C	3°C
--------	-----	-------	-----	-------	-----



UPC400 & CD400



300MPC



CODE	300MPC	UPC400 / UPC400TR**
EXTERIOR DIM. W x D x H	42,5 x 62 x 57 cm	46 x 63,3 x 62 cm
INTERIOR DIM. W* x D x H	34 x 53,5 x 36 cm	33,5 x 53,3 x 49 cm

Case Pack: 1 * Rail to Rail ** Security Package (SP).

HOLDING CAPACITY: Number of GN 1/2 pans

Pan Depth	300MPC	UPC400
6,5 cm	4	6
10 cm	3	4
15 cm	2	3
20 cm	1 +	2
	1 each 6,5 cm	

Also holds GN 1/2 and 1/3 size pans.

Optional Accessories

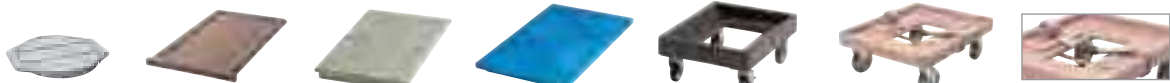

CODE	1210PW	300DIV	400DIV	CP1220	CD300*	CD400	400STP
DESCRIPTION	Camwarmer®	ThermoBarrier®	ThermoBarrier	Camchiller®	Camdolly®	Camdolly	Strap
EXTERIOR DIM. (cm)	34,9 x 27,6 x 4	53 x 33 x 2,5	54 x 33 x 3,8	53 x 33 x 3,8	49 x 65 x 26,5	71 x 53 x 23	500 Long
INTERIOR DIM. (cm)	—	—	—	—	43 x 59	63,5 x 46	—
COLOR	Granite Grey (191)	Coffee Beige (157)	Grey (180)	Cold Blue (159)	▲	▲	Beige (000)

Case Pack: 1 * Also available CD300H and CD300HB. See Camdolly section.

UPCS400 Ultra Pan Carrier® S-Series To Transport Gastronom Food Pans

- Ultra dependable, ultra durable front-loading pan carrier.
- Holds multiple pans of hot or cold food for hours.
- Durable polyethylene shell and thick, polyurethane foam insulation.

◆ **UPCS400 Colors:** Slate Blue (401), Speckled Grey (480), Dark Brown (131).



▲ **CD400 Colors:** Coffee Beige (157), Dark Brown (131), Black (110), Slate Blue (401), Grey (180).

Casters: 12,7 cm 2 fixed, 2 swivel, 1 with brake.

Note: Best results will be achieved by loading food pans between 82° to 88°C. Loading metal food pans over 121°C may result in damage to the carrier or cart.



Stacks with both UPCS400. Fits on CD400 Camdolly, or optional casters may be added for smooth ground transport.

HOLDING CAPACITY:

PAN DEPTH	NUMBER OF GN 1/1 PANS
6,5 cm	6
10 cm	4
15 cm	3
20 cm	2

Also holds GN 1/2 and 1/3 size pans.



CONVENIENT
Integrated pan-staging area eases service (not for use during transport).

EASY CONTENT AND ROUTING LABELING
Menu clip reduces need to open door.



ERGONOMIC DESIGN
Unbreakable, ergonomic, molded-in handles for comfortable two-person carrying.

EASY TO CLEAN
Door removes for easy cleaning.

TEMPERATURE RETENTION
Polyurethane insulation keeps hot food hot and cold food cold.



PRESSURE CONTROL
Built-in vent equalizes pressure and releases steam.

QUICK ACCESS
Single, 23 cm nylon latch for quick and secure opening and closing.



BUILT-IN SEAL
Built-in seal eliminates need for removable gasket.

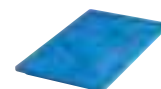
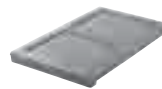
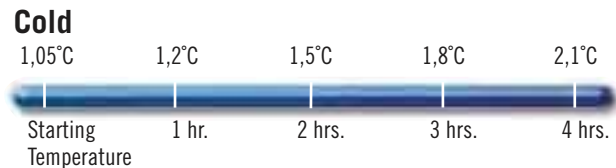
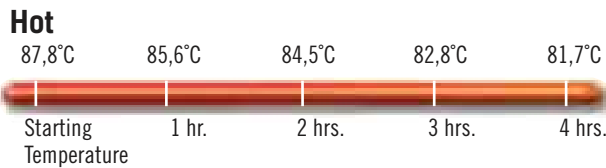

CODE	UPCS400	UPCS400CK	1210PW	400DIV	CP1220	CD400	400STP
DESCRIPTION	Insulated Carrier	Caster Kit*	Camwarmer®	ThermoBarrier	Camchiller	Camdolly®	Strap
EXTERIOR DIM. (cm)	63,5 x 46 x 63	∅ 12,7	34,9 x 27,6 x 4	54 x 33 x 3,8	53 x 33 x 3,8	71 x 53 x 23	500 cm Long
INTERIOR DIM. (cm)	53,5 x 33,5 x 48,6	—	—	—	—	63,5 x 46	—
COLOR	◆	—	Granite Grey (191)	Grey (180)	Cold Blue (159)	▲	Beige (000)

Case Pack: 1 *Optional Caster Kit: 2 fixed, 2 swivel, 1 w/ brake.

Ultra Camcarts® To Transport Gastronom Food Pans



- Double-compartment, high-capacity carts hold and transport hot or cold food.
- Tough, polyethylene shell and thick foam insulation throughout cabinet and between compartments.
- Airtight removable gaskets maintain safe food temperatures for hours.
- Easy to maintain and won't dent, crack, rust, chip or break.
- Durable nylon door latches open easily and close securely.
- Full-swing doors open to the side of the cart for easy loading and unloading.
- Molded-in handles ensure easy maneuvering.
- Molded-in bumpers minimize damage to walls, furniture and other equipment.

Colors: Navy Blue (186), Slate Blue (401), Coffee Beige (157), Dark Brown (131), Brick Red (402), Green (519), Black (110), Hot Red (158), Granite Grey (191), Granite Green (192), Granite Sand (194).

Tamper-resistant models (for correctional industry) use hinge pins that cannot be removed.

Note: Place food pans on rails. Pans should not be placed on the floor of a Camcart cavity. Please use specified food pan sizes.

Note: Best results will be achieved by loading food pans between 82° to 88°C. Loading metal food pans over 121°C may result in damage to the carrier or cart.

Venting plug is covered by US Patent D 553,717 S.

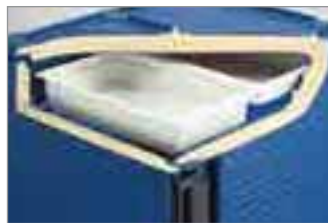

Polyurethane insulation keeps hot food hot and cold food cold.



Shown with optional HD casters.

Security Package (SP)

Specifically designed for operations where safety and security are a top priority.

These models feature components that withstand severe conditions without safety risks: Tamper-resistant screws on latches. Non-removable doors. Casters and chassis plates mounted with tamper-resistant bolts. Locking hasp for padlocks (not included).



Marine rail is designed for use during service, not transport.

TOTAL CART HOLDING CAPACITY	UPC600	UPC800	UPC1200	UPC1600
Full Size Food Pans				
6,5 cm deep	8 pans	12 pans	16 pans	24 pans
10 cm deep	6 pans	8 pans	12 pans	16 pans
15 cm deep	4 pans	6 pans	8 pans	12 pans
20 cm deep	2 pans + 2 each 10 cm pans	4 pans	4 pans	8 pans
Camtray®				
3253	12 trays	12 tray	12 trays	48 trays
2632	24 trays	48 trays	—	—
2025	—	—	12 trays	24 trays

See Food Pan and Camtray® Section for ordering information.

*Based on 3,8 cm spacing between trays.

Hot

UPC600	86,8°C	84,3°C	82,5°C	80,8°C	79,3°C
UPC800	87,7°C	85,5°C	84,2°C	82,9°C	81,7°C
UPC1200	85,6°C	82,1°C	80,1°C	78,3°C	77,2°C
UPC1600	87,1°C	85,9°C	85,1°C	84,3°C	83,7°C



Cold

UPC600	0,6°C	1,1°C	1,4°C	1,8°C	2,1°C
UPC800	0,3°C	0,8°C	0,9°C	1,2°C	1,4°C
UPC1200	0,5°C	0,9°C	1,1°C	1,3°C	1,4°C
UPC1600	0,6°C	1,0°C	1,2°C	1,5°C	1,5°C

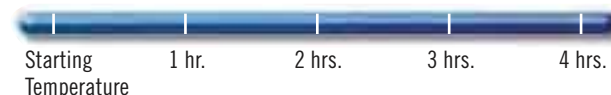



UPC600

CODE	UPC600
DESCRIPTION	Base Model
EXTERIOR DIM. W x D x H	52 x 69 x 114,5 cm
COMPARTMENT DIMENSIONS	34 x 54 x 35,5 cm
Case Pack:	1
Casters:	12,7 cm, 2 fixed, 2 swivel, 1 with brake.



UPC800

CODE	UPC800	UPC800SP
DESCRIPTION	Base Model	Security Package
EXTERIOR DIM. W x D x H	52 x 69 x 137 cm	52 x 69 x 137 cm
COMPARTMENT DIMENSIONS	33 x 54,5 x 48,5 cm	33 x 54,5 x 48,5 cm
Case Pack:	1	
Casters:	15,2 cm, 2 fixed, 2 swivel, 1 with brake.	



UPC1200

CODE	UPC1200
DESCRIPTION	Base Model
EXTERIOR DIM. W x D x H	72,5 x 82 x 116 cm
COMPARTMENT DIMENSIONS	54 x 66,5 x 34,5 cm
Case Pack:	1
Casters:	15,2 cm, 2 fixed, 2 swivel, 1 with brake.



UPC1600

CODE	UPC1600	UPC1600HD	*UPC1600SP	UPCGL1600SP
DESCRIPTION	Base Model	Base Model with HD Casters	Security Package	Security Package, Gasketless
EXTERIOR DIM. W x D x H	71,5 x 82 x 135 cm	73 x 84,7 x 138,4 cm	71,5 x 82 x 135 cm	71,5 x 82 x 135 cm
COMPARTMENT DIMENSIONS	53,5 x 66,5 x 53,5 cm	53,5 x 66,5 x 53,5 cm	53,5 x 66,5 x 53,5 cm	53,5 x 66,5 x 53,5 cm

Case Pack: 1 **Casters:** 15,2 cm, 2 fixed, 2 swivel, 1 with brake.

HD: Heavy-duty, hi-modulus 15,24 x 5,08 cm. 2 fixed, 2 swivel with brake casters.

*Security Package (SP) have lock-in hinge pins and latches and wheels are attached with tamper resistant screws.



Optional Accessories

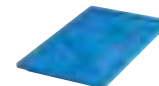
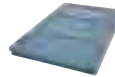
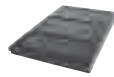
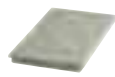

CODE	300DIV	400DIV	1200DIV	1600DIV	CP1220	1210PW
DESCRIPTION	ThermoBarrier®	ThermoBarrier	ThermoBarrier	ThermoBarrier	Camchiller®	Camwarmer®
EXTERIOR DIMENSIONS	L x W x H	L x W x H	L x W x H	L x W x H	L x W x H	L x W x H
	53 x 33 x 2,5 cm	54 x 33 x 2,5 cm	53 x 33,5 x 3,5 cm	53 x 33,5 x 3,8 cm	53 x 33 x 3,8 cm	34 x 27,5 x 4 cm
FITS	UPC600	UPC800, UPC800TR	UPC1200	UPC1600	UPC600, UPC800, UPC800TR, UPC1200, UPC1600, UPC1600TR	UPC600, UPC800, UPC800TR
COLOR	Coffee Beige (157)	Grey (180)	Dark Brown (131)	Slate Blue (401)	Cold Blue (159)	Granite Grey (191)

Case Pack: 1 1200DIV / 1600DIV **Case Pack:** 2

Transporter Capacity Guide

Loading Examples for Cambro® Insulated Transporters

TOP LOADERS

UPC140-UPC180
UPCS140-UPCS180
UPCSS160
125MPC

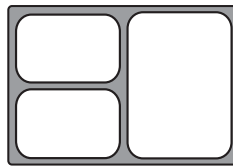
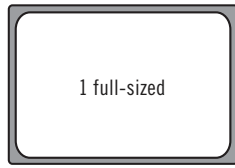

For a 3-course meal:
2 x GN ¼
1 x GN ½
1 DIV12 divider bar
(approx. 14 meals)

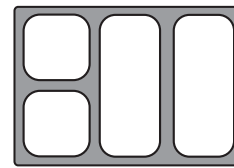

For a 4-course meal:
2 x GN ⅓
2 x GN ½
2 DIV12 divider bars
(approx. 14 meals)

TOP LOADERS

100 series
100MPC
UPC100
UPC101

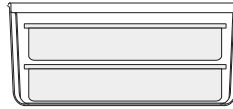
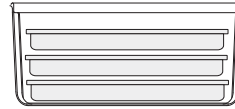

FRONT LOADERS

300MPC
UPC600 (x2)
UPC1200 (x4)

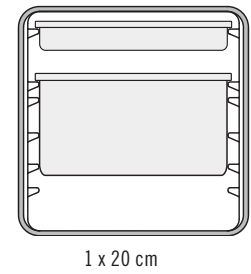
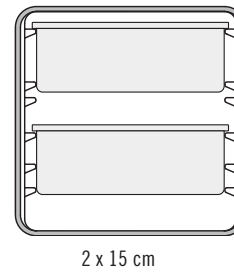
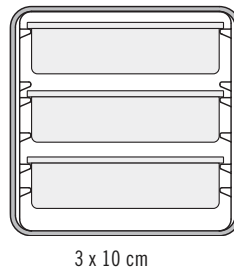
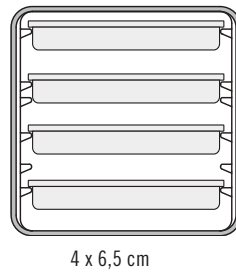
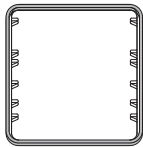

300MPC Rail Configuration

FRONT LOADERS

UPC400
UPCS400
UPCH4002
UPC800 (x2)
UPCH8002 (x2)
UPC1600 (x4)
UPCH1600 (x4)
CMB1826L (x2)

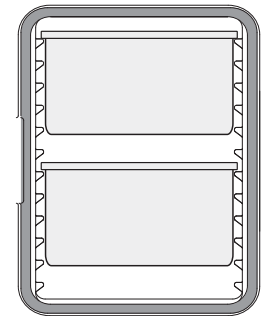
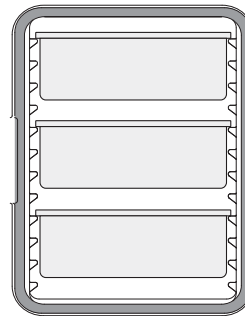
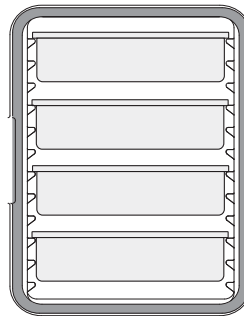
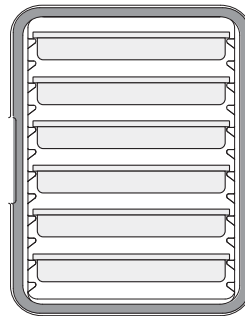

CAMCARRIERS® AND CAMCARTS® FOR SHEET PANS

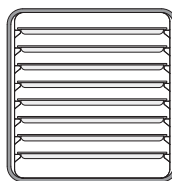

1318MTC
8 x ½ size
sheet pans

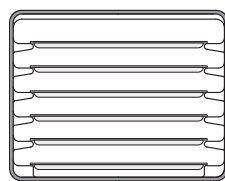

1826MTC
6 x full-size
sheet pans
1826DTC (x4)
CMB1826L (x2)

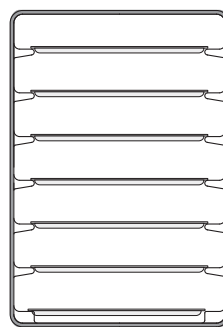

1826LTC3
7 x full-size
sheet pans

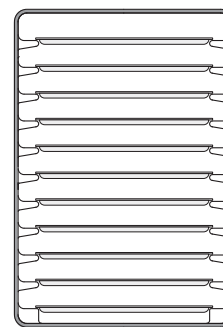

Camtherm Low
11 x full-size
sheet pans
Camtherm Tall (x2)

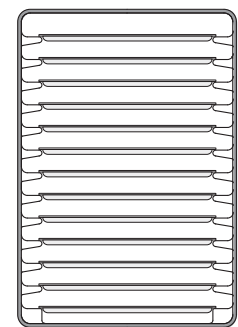

1826LTC
13 x full-size
sheet pans

SUMMARY OF GN CONTAINER SIZES

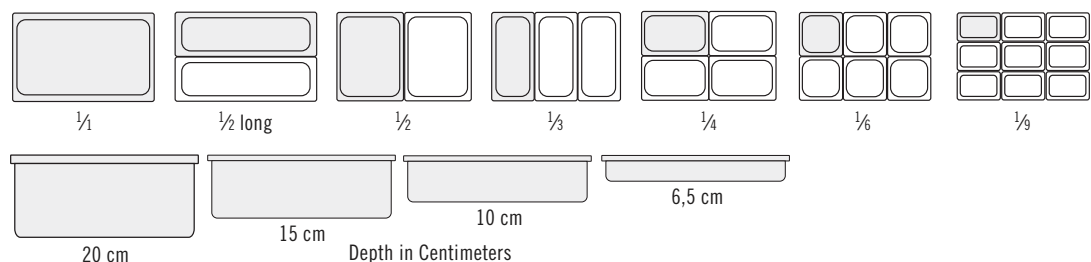

Ultra Pan Carrier® and Ultra Camcart® H-Series

- Designed for both electric hot holding and non-electric transport.
- Gentle, 65° to 74°C non-radiant heat will not cook food and maintains food moisture.
- Holds a wide variety of foods such as pasta, bone-in fried chicken, and double-crust pies.
- One hour preheat time from room temperature and three minute recovery.
- Energy consumption is substantially less than comparable metal cabinets.
- Will not rust or dent like metal cabinets, is more economical, and is easy to maneuver.
- All UPCH models have been tested to maintain safe, hot food temperatures, for up to 4 hours when unplugged.
- Models with only the top heated door offer unique versatility with an electric hot holding cabinet on top and passive hot or cold food holding on the bottom.
- Heated door kits also sold separately to retrofit UPC400, UPC800 and UPC1600.

Colors: Granite Gray (191), Black (110), Granite Green (192), Slate Blue (401), Dark Brown (131), Black (110).

Casters: 15,2 cm 2 fixed, 2 swivel, 1 with brake.



Power On and Heat On Indicators

Communicate the Power and Heating status of the UPCH1600 unit. Know instantly when the compartment has reached target temperature.



Vents

Consistent heating throughout the compartment is generated by vents that constantly circulate heat from front to back.



Tough Exterior

All UPCH units are made of tough, polyethylene with polyurethane foam insulation to keep heat in while keeping the exterior cool to the touch. Will not crack, dent, chip, rust or break.



Insulation

CFC-free, foamed-in place polyurethane foam insulation will hold temperature above 64°C for up to 4 hours when used unplugged.

Ultra Pan Carrier® and Ultra Camcart® H-Series

Marine rail is designed for use during service, not transport.



UPCH4002



UPCH8002



UPCH16002

MODEL	UPCH400/ UPCH800 (110 VAC MODELS)	UPCH4002/ UPCH8002 (220 VAC MODELS)	UPCH1600 (110 VAC MODELS)	UPCH16002 (220 VAC MODELS)
Electrical Specifications				
Required Voltage	110 - 120 VAC	200 - 230 VAC	110 - 125 VAC	200 - 230 VAC
Maximum Amp.	2,0a	1,2a	4,6a	2,3a
Watts	230w	265w	529	506w
Hertz	50/60	50/60	50/60	50/60
Plug Type	Nema 5-15P	Euro plug, CEE7	5-15P to C15RA	CEE7/7 to C15RA
Power Cord Length	2,7 m	2,7 m	2,7 m	2,7 m

Hot Holding When Unplugged

UPCH4002	87,8°C	82,8°C	81,7°C	80°C	78,9°C
UPCH8002	87,8°C	83,9°C	82,8°C	81,1°C	80°C
UPCH16002	87,8°C	82,8°C	81,7°C	80°C	78,9°C



HOT HOLDING

65° — 74°C

WARM UP TIME

(from ambient to temperature)

1 hour

RECOVERY TIME*

(time to recover to temperature after door is held open for 30 seconds)

3 minutes

TRANSPORT TIME*

(after reaching temperature, amount of time unit can be held passively/unplugged until contents reach 65°C.)

4 hours+

*Based on test with 6 each, 15,24 cm deep H-pans with GripLids® filled with approx 14,2 L of 87,7°C water. (Temperatures are of the water not the air in the cart).

Capacity Guide

UPCH4002
UPCH8002 (x2)
UPCH16002 (x4)

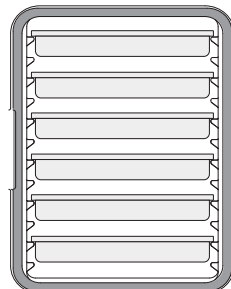

6 x 6,5 cm

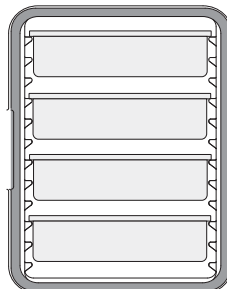

4 x 10 cm

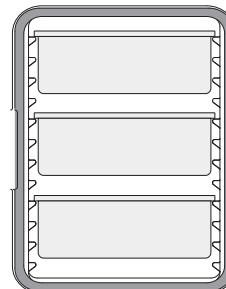

3 x 15 cm

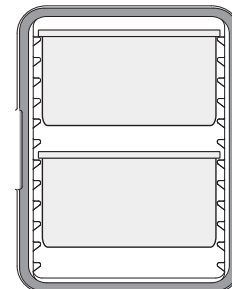

2 x 20 cm

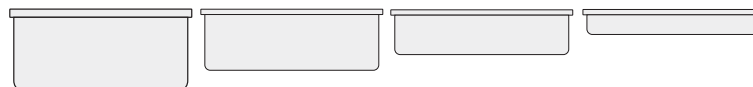

Food Pan Portion Guide

GN 1/4 Food Pan

Depth:	20 cm	15 cm	10 cm	6,5 cm
Serving Portions Per Pan (1 cup):	80	60	40	30

Ultra Pan Carrier® and Ultra Camcarts® H-Series

- Enables HACCP compliance by maintaining safe, hot food temperatures.
- UPCH400(2) models stack for storage or transporting on a Camdolly® with securing strap.

Colors: Granite Grey (191), Granite Green (192), Slate Blue (401), Black (110), Dark Brown (131).

CD400 Colors: Coffee Beige (157), Dark Brown (131), Black (110), Slate Blue (401), Grey (180).

Casters: 15,2 cm 2 fixed, 2 swivel, 1 with brake.

Note: If using metal food pans, cool to 120°C before placing onto rails.

Note: Place food pans on rails. Pans should not be placed on the floor of a Camcart cavity. Please use specified food pan sizes.

Vent Cap Patent Pending.



CODE	DESCRIPTION	EXTERIOR DIMENSIONS W x D x H	COMPARTMENT DIMENSIONS W x D x H
1-Compartment Ultra Pan Carriers			
110V			
UPCH400	No casters	46 x 67 x 63 cm	33,5 x 53,3 x 48,6 cm
UPCHW400	With casters	46 x 67 x 79,4 cm	33,5 x 53,3 x 48,6 cm
220V			
UPCH4002	No casters	46 x 67 x 63 cm	33,5 x 53,3 x 48,6 cm
UPCHW4002	With casters	46 x 67 x 79,4 cm	33,5 x 53,3 x 48,6 cm
2-Compartment Ultra Camcarts			
110V			
UPCH800	Both doors heated	52 x 69 x 137,2 cm	33 x 54,5 x 48,5 cm
UPCHT800	Top door heated only	52 x 69 x 137,2 cm	33 x 54,5 x 48,5 cm
UPCH1600	Both doors heated	73 x 84,7 x 137,5 cm	53,5 x 66,5 x 53,5 cm
UPCH1600HD	Both doors heated, HD casters	73 x 84,7 x 138,4 cm	53,5 x 66,5 x 53,5 cm
UPCHT1600	Top door heated only	73 x 84,7 x 137,5 cm	53,5 x 66,5 x 53,5 cm
UPCHT1600HD	Top door heated only, HD casters	73 x 84,7 x 138,4 cm	53,5 x 66,5 x 53,5 cm
UPCHTR1600	Both door heated, Tamper Resistant	73 x 84,7 x 138,4 cm	53,5 x 66,5 x 53,5 cm
220V			
UPCH8002	Both doors heated	52 x 69 x 137,2 cm	33 x 54,5 x 48,5 cm
UPCHT8002	Top door heated only	52 x 69 x 137,2 cm	33 x 54,5 x 48,5 cm
UPCH16002	Both doors heated	73 x 84,7 x 137,5 cm	53,5 x 66,5 x 53,5 cm
UPCH16002HD	Both doors heated, HD casters	73 x 84,7 x 138,4 cm	53,5 x 66,5 x 53,5 cm
UPCHT16002	Top door heated only	73 x 84,7 x 137,5 cm	53,5 x 66,5 x 53,5 cm
UPCHT16002HD	Top door heated only, HD casters	73 x 84,7 x 138,4 cm	53,5 x 66,5 x 53,5 cm
UPCHTR16002	Both door heated, Tamper Resistant	73 x 84,7 x 138,4 cm	53,5 x 66,5 x 53,5 cm
Accessories			
CD400	Camdolly®	53 x 70 x 23 cm	—
400STP	Strap	5 m long	—

UPCH Case Pack: 1

Also Available: Top and Bottom Replacement/Retrofit Doors for 110V and 220V (non-interchangeable).

Standard Casters: 15,2 cm x 3,2 cm – 2 fixed, 2 swivel, 1 with brake. **HD Casters:** 15 x 5,08 cm – 2 fixed, 2 swivel with brake.

Combo Cart™ Plus (Non-Electric)



- The most versatile insulated transporter on the market! Holds food pans, sheet pans, trays and even large pizza boxes.
- Two separate compartments offer the flexibility of holding either hot or cold food.
- Tough, durable polyethylene exterior will not dent, rust or chip—a great alternative to metal holding carts!
- Thick, CFC-free polyurethane insulation throughout the cabinet ensures excellent food quality and temperature retention for 4 or more hours.
- Ideal for caterers, schools, hotels and large institutions.

Color: Charcoal Gray (615).

Note: Place food pans on rails. Pans should not be placed on the floor of the compartment. All food should be cooled to 121,11°C before placing into cart to avoid damage to the body.

Tall Combo Cart Plus Non-Electric covered by U.S. Patent D 679,468 S.



STAINLESS STEEL UNIVERSAL RAILS*
Holds sheet pans, food pans, pizza boxes and trays (or limitless combinations of these!)
*7 pairs/compartment

GASKET-FREE DOOR
Worry free door! Swings open completely to the side.



MENU POCKET
Allows for easy product ID with either an index card or by writing directly onto smooth surface with a grease pencil.



MARINE RAILING
Creates a bonus staging area for food pans.



ERGONOMIC VERTICAL MOLDED-IN HANDLES
Will never break; great for maneuvering by operators of all heights.

WIDE PADDLE LATCHES
For easy opening and closing.

PERIMETER BUMPER
Protects cart and walls.



CASTERS**
All swivel with brakes for smooth positioning and navigation; non-marking.
**Standard or Heavy Duty (HD) casters available.

INSULATION
CFC-free, polyurethane insulation throughout the body and doors maximizes heat or cold retention for 4 hours or more.

Combo Cart™ Plus (Non-Electric)

CODE	CASTER TYPE	UNIT WEIGHT (KG)
Low		
CMBPL	Standard Casters	52,6
CMBPLHD	HD Casters	56,9
Tall		
CMBP	Standard Casters	95,3
CMBPHD	HD Casters	99,6
Security Package		
CMBPLSP	Low, Standard Casters	53,0
CMBPLSPHD	Low, HD Casters	57,3
CMBPSP	Tall, Standard Casters	95,7
CMBPSPHD	Tall, HD Casters	100,0

Standard Caster: 15 x 3,2 cm
(all swivel, with brakes)

Heavy Duty Caster: 15 x 5 cm
(all swivel, with brakes)

Exterior Dimensions (Low)

W x D x H: 70,2 x 85,1 x 104,5 cm

Exterior Dimensions (Tall)

W x D x H: 70,2 x 85,1 x 167,3 cm

Compartment Dimensions with column rails (W x D x H): 53,7 x 66,7 x 64,8 cm

Case Pack: 1 **Color:** Charcoal Gray (615).

Security Package

Tamper-resistant screws on the latch handle assembly. Non-removable retainer rings on each hinge pin make doors non-removable. Locking hasp for padlocks. Tamper-resistant fasteners for columns and cross-locking wires behind the columns lock the rails into place.

Optional Accessories

CODE	DESCRIPTION
CMBPR1	1 Pair of Rails
CMBPR7	7 Pairs of Rails

Case Pack: 1 **Color:** (000).



Holding Capacity Reference

TYPE OF CONTAINER	STANDARD CAPACITY	RAIL SPACING	MAXIMUM CAPACITY	RAIL SPACING
45,7 x 66 CM FULL SIZE SHEET PANS	14	8,6 cm	32*	3,8 cm
33 x 5,7 CM FULL SIZE SHEET PANS	28	8,6 cm	64*	3,8 cm
GN ¼ 6,5 CM DEEP HOTEL PANS	28	8,6 cm	28	8,6 cm
GN ¼ 10 CM DEEP HOTEL PANS	20**	12,7 cm	20	12,7 cm
40 x 60 CM TRAYS	14	8,6 cm	32*	3,8 cm
32,5 x 53 CM TRAYS	28	8,6 cm	52*	4,8 cm
40,6 x 40,6 x 5,1 CM PIZZA BOXES	14	8,6 cm	22	5,7 cm

* Additional rails required.

** Only requires 5 pairs of rails.

Combo Cart™ Plus (Electric)



- The most versatile insulated transporter on the market! Holds food pans, sheet pans, trays and even large pizza boxes.
- Two separate compartments offer the flexibility of holding either hot or cold food by simply keeping it unplugged.
- Tough, durable polyethylene exterior will not dent, rust or chip and remains cool to the touch during operation—a great alternative to metal holding carts!
- Thick, CFC-free polyurethane insulation throughout the cabinet ensures excellent food quality and temperature retention for 4 hours or more, even when unplugged.
- Over 50% more energy-efficient, on average, than leading metal carts.
- Ideal for caterers, schools, hotels and large institutions.

Color: Charcoal Gray (615).

Note: Place food pans on rails. Pans should not be placed on the floor of the compartment. All food should be cooled to 121,11°C before placing into cart to avoid damage to the body.

Tall Combo Cart Plus Electric covered by U.S. Patent D 679,468 S.



STAINLESS STEEL UNIVERSAL RAILS*
Holds sheet pans, food pans, pizza boxes and trays (or limitless combinations of these!)

*7 pairs/compartment



GASKET-FREE DOOR

Worry free door! Swings open completely to the side.

MARINE RAILING

Creates a bonus staging area for food pans.



ERGONOMIC VERTICAL MOLDED-IN HANDLES

Will never break; great for maneuvering by operators of all heights.

SOLAR DIGITAL THERMOMETER

Monitor internal cabinet temperature at a glance.

ENERGY-SAVING HEATER

Tall cart - over 50% more energy efficient compared to leading metal carts, low carts - over 180%! Gentle, non-radiant heat circulates consistently from front to back of the cabinet.

POWER ON AND HEAT ON INDICATORS

Communicate the power and heating status of the unit. Know instantly when the compartment has reached target temperature. Turn on and off without unplugging the cord.

WIDE PADDLE LATCHES

For easy opening and closing.



PERIMETER BUMPER

Protects cart and walls.



INSULATION

CFC-free, polyurethane insulation throughout the body and doors maximizes heat or cold retention for 4 hours or more.

CASTERS**

All swivel with brakes for smooth positioning and navigation; non-marking.

**Standard or Heavy Duty (HD) casters available.

CORD KEEPER

Stores 2,7 m power cord neatly and safely.

MENU POCKET

Allows for easy product ID with either an index card or by writing directly onto smooth surface with a grease pencil.

Combo Cart™ Plus (Electric)

CODE	DESCRIPTION	UNIT WEIGHT (KG)
Low		
CMBPLH / CMBPLH2	Standard casters, 110V/220V	58,3
CMBPLHHD / CMBPLH2HD	HD casters, 110V/220V	62,6
Tall		
CMBPH / CMBPH2	Standard casters, 110V/220V	105,2
CMBPHHD / CMBPH2HD	HD casters, 110V/220V	109,5
Top Door Heated Only		
CMBPTH / CMBPTH2	Top Door Heated only, Standard casters, 110V/220V	104,6
CMBPTHHD / CMBPTH2HD	Top Door Heated only, HD casters, 110V/220V	108,9
Security Package		
CMBPLHSP	Low, Standard casters, 110V	58,6
CMBPLHSPHD	Low, HD casters, 110V	63
CMBPHSP	Tall, Standard casters, 110V	105,7
CMBPHSPHD	Tall, HD casters, 110V	110
CMBPTHSP	Top Door Heated only, Standard casters, 110V	105
CMBPTHSPHD	Top Door Heated only, HD casters, 110V	109,3

Case Pack: 1 Color: Charcoal Gray (615).

Standard Caster: 15 x 3,2 cm
(all swivel, with brakes)

Heavy Duty Caster: 15 x 5 cm
(all swivel, with brakes)

Exterior Dimensions (Low)

W x D x H: 70,2 x 85,1 x 104,5 cm

Exterior Dimensions (Tall)

W x D x H: 70,2 x 85,1 x 167,3 cm

Compartment Dimensions with column rails (W x D x H): 53,7 x 66,7 x 64,8 cm

Optional Accessories

CODE	DESCRIPTION
CMBPR1	1 Pair of Rails
CMBPR7	7 Pairs of Rails

Case Pack: 1 Color: (000).

Security Package

Tamper-resistant screws on the latch handle assembly. Non-removable retainers rings on each hinge pin make doors non-removable. Metal hasp for padlocks. Tamper-resistant fasteners for columns and cross-locking wires behind the columns lock the rails into place.



Electrical Specifications (Per Compartment)

	110V MODELS	220V MODELS
REQUIRED VOLTAGE	100-125 VAC	200-230 VAC
MAXIMUM AMP	4,6a	2,3a
WATTS	529w	506w
HERTZ	50/60	50/60
PHASE	Single	Single
PLUG TYPES	5-15 to C15RA	CEE7/7 to C15RA
ALTERNATE PLUG TYPES FOR INTERNATIONAL	JIS8303 to C15RA (Japan)	BS1363 to C15RA (UK / Ireland+more)
POWER CORD LENGTH	2,7 m	2,7 m

Holding Capacity Reference

TYPE OF CONTAINER	STANDARD CAPACITY	RAIL SPACING	MAXIMUM CAPACITY	RAIL SPACING
45,7 x 66 CM FULL SIZE SHEET PANS	14	8,6 cm	32*	3,8 cm
33 x 5,7 CM FULL SIZE SHEET PANS	28	8,6 cm	64*	3,8 cm
GN ¼ 6,5 CM DEEP HOTEL PANS	28	8,6 cm	28	8,6 cm
GN ¼ 10 CM DEEP HOTEL PANS	20**	12,7 cm	20	12,7 cm
40 x 60 CM TRAYS	14	8,6 cm	32*	3,8 cm
32,5 x 53 CM TRAYS	28	8,6 cm	52*	4,8 cm
40,6 x 40,6 x 5,1 CM PIZZA BOXES	14	8,6 cm	22	5,7 cm

* Additional rails required.

** Only requires 5 pairs of rails.

Camtherm® Electric Food Holding Cabinets

Camtherm Food Holding Cabinets hold and transport hot or cold food within the kitchen, on the truck, or at the point of delivery or service. Expand your kitchen capacity, maximize productivity, and hold food

safely for hours. Enjoy the confidence of knowing moist food will stay moist and crisp food will stay crisp. Discover how one cabinet can do the work of two : with the flip of a switch, go from hot to cold or cold

to hot to increase your storage capabilities and menu flexibility. Each cabinet combines extreme durability and excellent insulated holding performance with simple, energy-efficient thermoelectric

heating and cooling with :

- **NO COMPRESSOR**
- **NO HEATING COIL**
- **NO HUMIDIFIER**



Features & benefits available in both LOW and TALL profile Camtherm carts.

Top marine rail on all units holds 2 full-size food pans, one sheet pan or one cutting board (CB1220).

Solar powered, digital display thermometer monitors internal cabinet temperature.

Self-ventilating cap on each cabinet door automatically releases steam and equalizes pressure, maintaining food quality.

Menu clip holds routing directions or list of cabinet contents.

Non-marking, high modulus, rubber casters are strong and extremely durable providing smooth transport of full cabinets from kitchen to serving location.

Cabinet exterior stays cool during operation.

Doors swing open 270° for easy loading.

Aluminum louvers gently and evenly direct hot or cold air around the entire cabinet and contents, eliminating hot or cold spots and maintaining food quality.

Knuckle door hinges are built to withstand the rigors of numerous door openings. Doors lift up and off the hinges easily for cleaning.

Easy-to-use control panel is located on back of each unit. Includes on/off switch, hot/cold switch for hot/cold units only and a temperature control dial for hot only. Cold performing units are factory set to chill cabinet down to 2,8°C.

Molded-in bumpers protect walls and furniture and will never dent, chip or rust.



Ergonomic molded-in handles are at a safe height on both low and tall profile units for easy transporting, even when fully loaded.

Heavy-duty, 14 gauge electrical cord is 274 cm long. Wrapping hook is located on back of each cabinet for safe cord storage.

Wide, nylon door latches and magnetic door gaskets lock doors securely and create a tight seal to retain safe hot or cold food temperatures.

See caster information on following page.



Tough, one-piece, seamless double-wall polyethylene exterior is easy to clean and won't dent, crack, rust, chip or break.



Polyurethane insulation keeps hot food hot and cold food cold during transport when unit is unplugged.

Anodized aluminum uprights and removable, adjustable chrome plated steel slide rails hold full-size food pans or sheet pans.

Energy efficient heating and/or cooling unit located on back of each cabinet. Low volt, low amp, low watt system maintains consistent hot or cold temperature and balanced humidity throughout the single cavity cabinet.

Color: Granite Grey (191), Granite Green (192), Granite Sand (194).

Cutting Board Color: White (148).

Assembly is covered by U.S. Patent D 442,756 S & D 6,344,630. Venting plug is covered by US Patent D 553,717 S.

HOLDING CAPACITY LOW PROFILE

Includes 6 rail sets



Sheet Pan 11 Each 46 x 66 cm
Requires five additional rail sets.

Full-Size GN 1/2 Food Pan - 32,5 x 53 cm

- 12 GN 1/2 6,5 cm Deep
- 8 GN 1/2 10 cm Deep
- 6 GN 1/2 15 cm Deep
- 4 GN 1/2 20 cm Deep

HOLDING CAPACITY TALL PROFILE

Includes 12 rail sets



Sheet Pan 22 Each 46 x 66 cm
Requires ten additional rail sets.

Full-Size GN 1/2 Food Pan - 32,5 x 53 cm

- 24 GN 1/2 6,5 cm Deep
- 16 GN 1/2 10 cm Deep
- 12 GN 1/2 15 cm Deep
- 8 GN 1/2 20 cm Deep

Camtherm® Electric Food Holding Cabinets

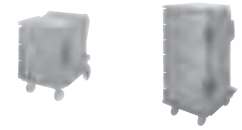

50% more energy efficient than a leading metal cabinet

Model	Total Energy Consumption Over 8 Hours
Camtherm	2,06 kilowatt hours
Metal Cabinet	3,95 kilowatt hours

ELECTRICAL SPECS

	LOW PROFILE	TALL PROFILE
Volts	110V	110V
Plug Type	Nema 5-15P	Nema 5-15P
Maximum amp draw	9,1 A	13,7 A
Amps run on	8,5 A	13,2 A
Watts	1100	1800
Hertz	50/60	50/60
Power input of heating unit	120 VAC	125 VAC

Product Specs CAD Drawings, Cut Sheets and User Manual
Available at www.cambro.com.





	CODE	THERMOMETER	CASTERS	UNIT WEIGHT KG
	EXTERIOR dimensions: W 78 x D 107 x H 108 cm			
	Hot Only			
	CMBH1826LC	Celsius	2 front 15,2 cm swivel w/brake, 2 rear 25,4 cm rigid	75 kg
	Hot/Cold			
	CMBHC1826LC	Celsius	2 front 15,2 cm swivel w/brake, 2 rear 25,4 cm rigid	101 kg
Correctional security package available, please contact Cambro for information				

	CODE	THERMOMETER	CASTERS	UNIT WEIGHT KG
	EXTERIOR dimensions: W 78 x D 100 x H 165 cm			
	Hot Only			
	CMBH1826TSC	Celsius	2 front 15,2 cm swivel w/brake, 2 rear 15,2 cm rigid	114 kg
	CMBH1826TBC	Celsius	2 front 15,2 cm swivel w/brake, 2 rear 25,4 cm rigid	116 kg
	Hot/Cold			
	CMBHC1826TSC	Celsius	2 front 15,2 cm swivel w/brake, 2 rear 15,2 cm rigid	148 kg
	CMBHC1826TBC	Celsius	2 front 15,2 cm swivel w/brake, 2 rear 25,4 cm rigid	150 kg
Cabinet Colors: Granite Grey (191), Granite Green (192), Granite Sand (194).				
Correctional security package available, please contact Cambro for information				



ACCESSORIES	CODE	DESCRIPTION	DIMENSIONS H x L x W	CASE PACK
	CMBR	Set of Slide Rails	51 x 12,2 cm	1 set of 2 Rails
	CB1220	Cutting Board	53,5 x 33,5 x 1,3 cm	1 each

Cutting Board Color: White (148).

Time & Temperature Performance

	WARM UP TIME <i>From ambient to hot.</i>		RECOVERY TIME <i>Time to recover to hot temperature after door is held open for 30 seconds.</i>		TRANSPORT TIME <i>After reaching hot temperature, amount of time unit can be held passively / unplugged until temperature reaches (65°C).</i>	
	(65°C)	(74°C)	(65°C)	(74°C)	(65°C)	(74°C)
	LOW					
 Hot Unit	33 minutes	45 minutes	2 minutes	4 minutes	5 hours	8 hours
 Hot/Cold Unit	33 minutes	45 minutes	2 minutes	4 minutes	5 hours	8 hours
TALL						
 Hot Unit	30 minutes	60 minutes	1 minute	3 minutes	4 hours	8 hours
 Hot/Cold Unit	45 minutes	75 minutes	1 minute	3 minutes	6 hours	8 hours

All results based on tests with 6 full-size 15 cm deep H-Pans™ filled with 87,7°C hot water, covered and placed inside upper cabinet only.

	WARM UP TIME <i>From ambient to cold.</i>		RECOVERY TIME <i>Time to recover to hot temperature after door is held open for 30 seconds.</i>		TRANSPORT TIME <i>After reaching cold temperature, amount of time unit can be held passively / unplugged until temperature reaches (65°C).</i>	
	(2,8°C)	(2,8°C)	(2,8°C)	(2,8°C)	(2,8°C)	(2,8°C)
	LOW					
 Hot/Cold Unit	50 minutes		4 minutes		2 Hours	
TALL						
 Hot/Cold Unit	75 minutes		4 minutes		1 Hour	

All results based on tests with 6 full-size GN ¼ 15 cm deep Polycarbonate Food Pans filled with 1,1°C cold water, covered and placed inside upper cabinet only. Vent Cap Patent Pending.

Insulated Bakery Container – 60 X 40 cm



- Designed for the baking industry in Europe.
 - Ideal for transporting products at safe cold temperatures to satellite locations.
 - Perfect for baked items with cream fillings or frozen dough.
 - Made with a durable polyethylene outer shell and thick polyurethane foam insulation.
 - Holds sheet pans:
 - 60 x 40 cm
 - 58 x 40 cm
 - 58 x 20 cm
 - 58 x 10 cm
 - or fiberglass tray:
 - 60 x 40 cm
- Choose between wire racks with 6 rails, 10 cm apart, or 7 rails, 8,7 cm apart.

CP6040 color: Cold Blue (159).

Wire rack color: Silver (000).

Fiberglass Tray colors:

Speckled Smoke (A20),
Speckled Mocha (A21), Sahara (A22),
Light Grey (A27), Pearl White (A33),
Terrazzo (A86).

Note: Place sheet pans on rails. Pans should not be placed on the floor of a Container cavity. Please use specified sheet pan sizes.

Vent Cap Patent Pending.



Camdolly® CD300 makes it easy to transport BK60406 or BK60407.



CODE	BK60406*	BK60407*
DESCRIPTION	Container with 6 rails	Container with 7 rails
EXT. DIM.	76,5 x 57 x 82 cm	76,5 x 57 x 82 cm
INT. DIM.	42 x 63,5 x 67,5 cm	42 x 63,5 x 67,5 cm

Case Pack: 1 Color: Navy Blue (186) * Includes 2 wireracks and 1 chiller.

Accessories

CODE	CD300	CP6040	WR60406	WR60407	GL4060**
DESCRIPTION	Camdolly	Camchiller	Wiereracks w/6 rails	Wiereracks w/7 rails	Market display tray
EXT. DIM.	49 x 65 x 26,5 cm	60 x 40 x 4 cm	66 x 40,5 x 5,8 cm	66 x 40,5 x 5,8 cm	60 x 40 cm
INT. DIM.	43 x 59 cm	—	—	—	—
CASE PACK	1	1	1	1	12

** Not sold in USA, Canada, Mexico, Central America and Caribbean. Vent Cap Patent Pending.

Camcarts® – 46 X 66 cm Trays, Sheet Pans & Food Boxes

- Use to hold hot or cold bulk food stored on trays, sheet pans or in food boxes.
- Durable polyethylene and thick foam insulation retain safe food temperatures.
- Sturdy plastic, rust-proof latches are secured into molded-in mounting plates.
- Molded-in handle on the back for easy maneuvering.

Colors: Slate Blue (401),
Coffee Beige (157), Dark Brown (131),
Grey (180).

15,2 cm Casters: 2 fixed, 2 swivel,
1 with brake.

Note: Cool metal sheet pans to 121°C
before placing onto tray supports.

Venting plug is covered by US Patent
D 553,717 S.



1826DBC
only.



1826DTC Double Cavity Cart for Trays and Sheet Pans

Capacity: 24 tray support rails on
4,92 cm centers (12 per cavity).
Holds up to 24 each 46 x 66 cm
trays or sheet/bun pans.



1826DBC Double Cavity Cart for Food Storage Boxes

Capacity: 26 support rails on
4,92 cm centers (13 per cavity).
Holds 46 x 66 cm Food
Storage Boxes.



Camcart with Security Package

Specially designed for high security
applications, with tamper-resistant
hardware: metal hinges with non-
removeable pins, metal latches with
welded bails, lockable hasp and no
chassis plate.

CODE	DESCRIPTION	EXTERIOR DIMENSIONS W x D* x H	INTERIOR DIMENSIONS W x D* x H
1826DTC	For trays & sheet pans	55 x 84,5 x 162 cm	46,4 x 67,3 x 64,6 cm
1826DBC	For food storage boxes	55 x 84,5 x 162 cm	46,4 x 67,3 x 64,9 cm
Camcarts with Security Packages			
1826DTCSP	For trays & sheet pans	55 x 84,5 x 162 cm	46,4 x 67,3 x 64,6 cm
1826DBCSP	For food storage boxes	55 x 84,5 x 162 cm	46,4 x 67,3 x 64,9 cm

Case Pack: 1 *Depth measurement includes handle.

Camcarriers® – 32,5 X 53 cm Trays, Sheet Pans & Food Boxes Camcarts® – 46 X 66 cm Trays, Sheet Pans & Food Boxes



1318MTC

Camcarrier for Full-size Food Pans, Trays and Half-size Sheet Pans

- Holds up to 8 each 33 x 46 cm sheet pans or 3 each full-size 10 cm deep food pans.
- Molded-in handles.
- Stackable for storage and transport.
- Fits CD300 Camdolly.



1826LBC

Camcart for Food Storage Boxes

- Holds 46 x 66 cm Food Storage Boxes.
- Capacity: 13 supports on 4,45 cm centers.
- Includes removable cutting board on top.



1826MTC

Camcarrier for Trays and Sheet Pans

- Holds up to 6 each 46 x 66 cm sheet pans.
- Six tray supports on 5,4 cm centers.
- Molded-in handles.
- Fits CD1826MTC Camdolly.



1826LTC3

Camcart for Trays and Sheet Pans

- Holds up to 7 each 46 x 66 cm trays or sheet pans.
- Seven tray supports on 9,5 cm centers for 7,62 cm clearance between trays.
- Includes removable cutting board on top.



1826LTCSP

Camcart with Security Package

- Specially designed for high security applications.
- Features tamper-resistant hardware to protect both cart and contents.
- Includes removable cutting board on top.



1826LTC

Camcart for Trays and Sheet Pans

- Holds up to 13 each 46 x 66 cm trays or sheet pans.
- Thirteen tray supports on 4,45 cm centers.
- Includes removable cutting board on top.

Colors: Slate Blue (401), Grey (180), Coffee Beige (157), Dark Brown (131), Navy Blue (186). 1826MTC is available in Black (110).

1318MTC Colors: Navy Blue (186), Slate Blue (401), Coffee Beige (157), Dark Brown (131), Black (110). 1318MTC not available in Grey (180).

Strap Color: Beige (000).

Camdolly® Colors: Slate Blue (401), Coffee Beige (157), Dark Brown (131), Grey (180), Black (110).

CD1826MTC: 12,7 cm Casters: 2 fixed, 2 swivel, 1 with brake.

CD1826MTCHB: 12,7 cm Casters: 2 swivel, 1 with brake and 2 25,4 cm Easy Wheels.

* With handle.

** Cart comes complete with tamper-resistant hardware for maximum security applications.

15,2 cm Casters: 2 fixed, 2 swivel, 1 with brake.

Note: Cool metal sheet pans to 121°C before placing onto tray supports.

CODE	DESCRIPTION	EXTERIOR DIMENSIONS W x D* x H	INTERIOR DIMENSIONS W x D* x H
1318MTC	For trays, sheet pans & GN Food Pans	42,5 x 62 x 57 cm	33,3 x 53,3 x 36 cm
1826MTC	For trays & sheet pans	55 x 74,5 x 57 cm	46,7 x 66,4 x 33,3 cm
Camdolly			
CD300	Camdolly for 1318MTC	53 x 70 x 23 cm	46 x 63,5 cm
CD1826MTC	Camdolly for 1826MTC	61 x 89 x 91 cm	55,9 x 72,4 cm
CD1826MTCHB	Camdolly with Easy Wheels for 1826MTC	70 x 89 x 93,5 cm	55,6 x 72,5 cm
Camcarts			
1826LTC	For trays & sheet pans	55 x 81,5 x 95,5 cm	46 x 66,4 x 66,7 cm
1826LTC3	For trays & sheet pans	55 x 81,5 x 95,5 cm	46 x 66,4 x 66,7 cm
1826LBC	For Food Storage Boxes	55 x 81,5 x 95,5 cm	46 x 66,4 x 66,7 cm
Camcarts with Security Package**			
1826LTCSP	For trays & sheet pans	55 x 81,5 x 95,5 cm	46 x 66,4 x 66,7 cm
1826LBCSP	For Food Storage Boxes	55 x 81,5 x 95,5 cm	46 x 66,4 x 66,7 cm
Securing Strap			
1826STP	Securing Strap	—	—

Case Pack: 1 Venting plug is covered by U.S. Patent D 553,7175 S



Tablotherm Insulated Trays

SPECIFICATIONS

Material	Polypropylene + Foam Insulation
Characteristic	Insulated Tray
Performance	Excellent
Heat Retention	Approximately 60 Minutes*
Dishwasher Safe	Yes
Stackable	Yes
Minimum Food & Plate Temperature before Plating	85°C - 90°C
Individual Dish Cover	Yes – Prevent Spilling of Soup and Sauces



*With heated pellet.
Not for use in heated carts.



ITPD3253 - Gastronorm size

ITPD3753 - Euronorm size

For a complete guide to maximizing heat retention, contact your Cambro representative.

CODE	DESCRIPTION	DIMENSIONS W x L x H (CM)
Tablotherm – Insulated Tray with Porcelain Dishes, seal covers and pellet		
ITPD3753	Euronorm insulated tray including: 1 ea. two-compartment menu plate - 122 400 050 and 1 ea. cover 122 600 050 and 1 ea. pellet 165PW 3 ea. multiple-use bowl - 122 500 050 and 3 ea. cover 122 700 050.	37,0 x 53,0 x 10,5
ITPD3253	Gastronorm insulated tray including: 1 ea. two-compartment menu plate - 122 400 050 and 1 ea. cover 122 600 050 and 1 ea. pellet 165PW 2 ea. multiple-use bowl - 122 500 050 and 2 ea. cover 122 700 050.	32,5 x 48,0 x 10,5
Tablotherm – Insulated Tray without porcelain dishes, seal covers and pellet		
IT3753	Euronorm insulated tray – Empty	37,0 x 53,0 x 10,5
IT3253	Gastronorm insulated tray – Empty	32,5 x 48,0 x 10,5
Porcelain dishes		
122 400 050	Two compartment menu plate. Outside ø 254 mm. Capacity 750 ml. White.	
122 500 050	Multiple-use bowl. Outside ø 120 mm. Capacity 400 ml. White.	
Latches		
122 201 050	Latches with menu card holder	
122 200 050	Latches without menu card holder	
Food covers, light gray, polypropylene with integrated rubber seal		
122 600 050	For two compartment menu plate	
122 700 050	For multiple-use bowl	
Pellet System		
165PW	SMC pellet ø 16,5 cm	
Menu card		
112 430 000	Yellow 100 x 70 mm	

ITPD3753, IT3753 Color: Two Tone Green.

ITPD3253, IT3253 Color: Two Tone Gray.

165PW Color: A42 165PW Case Pack: 1 Each.

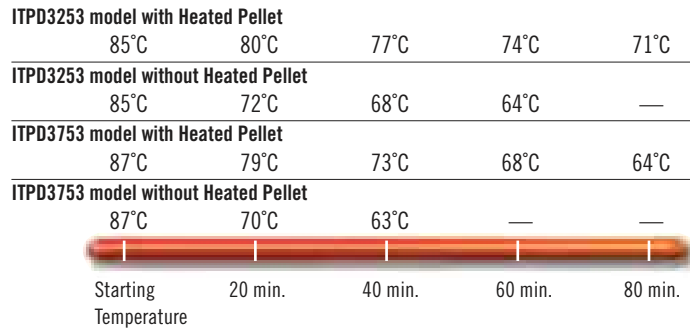

RECOMMENDED USE

Moderate Use

- Hospital Meal Delivery / Nursing Homes
- Hotel Room Service
- Catering
- Home Meal Delivery



Light gray polypropylene lid with integrated rubber seal. Lid cannot be used in microwave oven.



Mobile Vending Equipment



- Versa Food Service System
- Table Top Food Bars, Buffet Bars & Sneeze Guards
- Sample Food Bar Set-ups
- CamKiosk® System
- Camcruiser® Vending Carts
- Booster Seats & Versa Organizers
- Portable CamBars®
- Slidinglid™ Ice Caddies

Versa Food Service System



The Versa Food Service System provides custom design without the custom price. This non-electric, completely portable system goes anywhere and keeps food cold for hours with either ColdFest® pans or Buffet Camchillers®. Whether it's space considerations, frequent menu changes or merchandising requirements, the Versa Food Service System offers unequalled versatility.

- All components are fully compliant with NSF requirements.
- Countless configurations to fit any food service need.
- All-weather material is durable and easy to clean.
- Ergonomic, molded-in handles on both sides ensure easy maneuvering.
- One person can set-up or knock-down the sneeze guards and tray rails for transport or storage in only 30 seconds.
- Easily fits through a standard 91,5 cm doorway with the sneeze guards and tray rails knocked down. Knocked down width: 83 cm.

- Drain faucet can be connected to a hose for drainage and easy cleaning.



Add an end table to a Versa Food Bar® or Versa Work Table to hold trays, plates or condiments.

Versa Cart

The Cart includes an adjustable shelf, standard lockable drawer and a front panel for convenient electrical access. Tray rails easily adjust to a lower height.

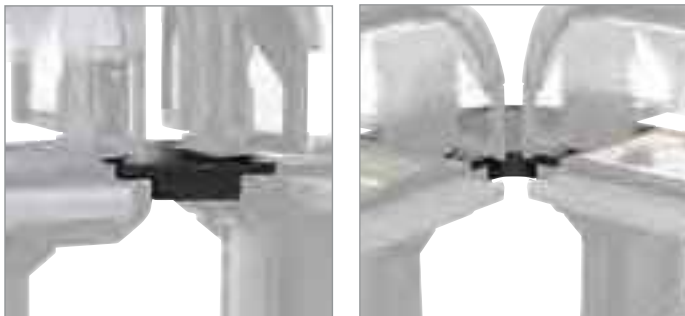

Versa Straight Connector and Versa Corner Connector

Easily and safely attach multiple components together to create a contiguous system and maximize space and merchandising options.



Versa Cart Keyboard Tray

Convenient, pull-out keyboard tray improves ergonomics and fits inside the standard lockable drawer.



Buffet Camchillers®

Extend safe, cold holding time without ice. Dual-sided Buffet Camchillers hold 6,5 cm and 10 cm pans. Fits in the Versa Food Bar®, Versa Work Table and Table Top Food Bars.

Versa Food Service System

Whether you're looking to maximize space, improve traffic flow, add merchandising space or create an upscale salad bar, the Versa Food Service System has you covered.



Versa Work Table

- Perfect for a prep table, display, self-serve station or back bar.
- Attach a Work Table to a Food Bar to merchandise snacks and beverages.
- Matching well covers are included with each Versa Work Table.

Standard height model.

Versa Food Service System – Ultra Series

Versa Food Bar® Ultra Series

- Now available with two secure storage cabinets that can hold up to 22,7 kg per compartment of non-perishable items.



Storage dimensions:
54,61 L x 44,45 W x 45,72 H cm per cabinet.
Each cabinet is 0,11 M³.

Versa Food Service System

CODE	DESCRIPTION	OVERALL EXTERIOR DIMENSIONS L x W x H	FULL PAN SIZE CAPACITY	WELL INTERIOR DIMENSIONS L x W x H
Versa Food Bars® - Standard Height				
VBR5	152 cm with Standard Casters	175,3 x 108 x 159,4 cm	4	132,8 x 53,3 x 18 cm
VBRHD5	152 cm with Heavy Duty Casters	175,3 x 108 x 159,4 cm	4	132,8 x 53,3 x 18 cm
VBR6	183 cm with Standard Casters	208,3 x 108 x 159,4 cm	5	165,4 x 53,3 x 18 cm
VBRHD6	183 cm with Heavy Duty Casters	208,3 x 108 x 159,4 cm	5	165,4 x 53,3 x 18 cm
Versa Food Bars® Ultra Series - Standard Height				
VBRU5	152 cm with Standard Casters and Storage	175,3 x 108 x 159,4 cm	4	132,8 x 53,3 x 18 cm
VBRUHD5	152 cm with Heavy Duty Casters and Storage	175,3 x 108 x 159,4 cm	4	132,8 x 53,3 x 18 cm
VBRU6	183 cm with Standard Casters and Storage	208,3 x 108 x 159,4 cm	5	165,4 x 53,3 x 18 cm
VBRUHD6	183 cm with Heavy Duty Casters and Storage	208,3 x 108 x 159,4 cm	5	165,4 x 53,3 x 18 cm
Versa Food Bars – Low Height				
VBRL5	152 cm with Standard Casters	175,3 x 108 x 141,6 cm	4	132,8 x 53,3 x 18 cm
VBRLHD5	152 cm with Heavy Duty Casters	175,3 x 108 x 141,6 cm	4	132,8 x 53,3 x 18 cm
VBRL6	183 cm with Standard Casters	208,3 x 108 x 141,6 cm	5	165,4 x 53,3 x 18 cm
VBRLHD6	183 cm with Heavy Duty Casters	208,3 x 108 x 141,6 cm	5	165,4 x 53,3 x 18 cm
Versa Work Tables – Standard Height				
VBRT5	152 cm with Standard Casters	175,3 x 69,6 x 99,06 cm	4	132,8 x 53,3 x 18 cm
VBRTHD5	152 cm with Heavy Duty Casters	175,3 x 69,6 x 99,06 cm	4	132,8 x 53,3 x 18 cm
VBRT6	183 cm with Standard Casters	208,3 x 69,6 x 99,06 cm	5	165,4 x 53,3 x 18 cm
VBRTHD6	183 cm with Heavy Duty Casters	208,3 x 69,6 x 99,06 cm	5	165,4 x 53,3 x 18 cm
Versa Work Tables Ultra Series - Standard Height				
VBRTU5	152 cm with Standard Casters and Storage	175,3 x 69,6 x 99,06 cm	4	132,8 x 53,3 x 18 cm
VBRTUHD5	152 cm with Heavy Duty Casters and Storage	175,3 x 69,6 x 99,06 cm	4	132,8 x 53,3 x 18 cm
VBRTU6	183 cm with Standard Casters and Storage	208,3 x 69,6 x 99,06 cm	5	165,4 x 53,3 x 18 cm
VBRTUHD6	183 cm with Heavy Duty Casters and Storage	208,3 x 69,6 x 99,06 cm	5	165,4 x 53,3 x 18 cm
Versa Work Tables – Low Height				
VBRTL5	152 cm with Standard Casters	175,3 x 69,6 x 74,3 cm	4	132,8 x 53,3 x 18 cm
VBRTLHD5	152 cm with Heavy Duty Casters	175,3 x 69,6 x 74,3 cm	4	132,8 x 53,3 x 18 cm
VBRTL6	183 cm with Standard Casters	208,3 x 69,6 x 74,3 cm	5	165,4 x 53,3 x 18 cm
VBRTLHD6	183 cm with Heavy Duty Casters	208,3 x 69,6 x 74,3 cm	5	165,4 x 53,3 x 18 cm

Case Pack: 1

CODE	DESCRIPTION	OVERALL EXTERIOR DIMENSIONS L x W x H
Versa Cart		
VCSWR	With Dual Tray Rails and Standard Casters	134 x 81,9 x 109,2 cm (With Tray Rails up)
VCSWRHD	With Dual Tray Rails and Heavy Duty Casters	134 x 81,9 x 109,2 cm (With Tray Rails up)
VCS	With Standard Casters and no Tray Rails	81,9 x 81,3 x 109,2 cm
VCSHD	With Heavy Duty Casters and no Tray Rails	81,9 x 81,3 x 109,2 cm
Connectors		
VBRC	Straight Connector - Food Bar to Food Bar	68,6 x 48,3 x 10,8 cm
VBRC90	Corner Connector - Food Bar to Food Bar	91,4 x 91,4 x 10,8 cm
VCS32CNT	Straight Connector - Cart to Standard Height Food Bar / Work Table	68,58 x 51,75 x 8,26 cm
VCS32CNL	Straight Connector - Cart to Low Height Food Bar / Work Table	68,58 x 51,75 x 21,59 cm

Case Pack: 1 Versa Food Bar, Versa Work Table, Versa Cart Colors: Black (110), *Bronze (146), *Hot Red (158), *Navy Blue (186), *Kentucky Green (519).

Tray Rail and End Table Colors Only: Granite Gray (191), ** Black (110), **Sandstone (614).

* Made to order colors for Versa Food Bar, Versa Work Table, Versa Cart, Tray Rail and End Table.

** Made to order color for Tray Rail and End Table only. Made to order items not carried in stock, non-returnable.

Food Bar Accessories

Every Accessory You Need

- Crock and Salad Bowl Holders highlight and organize salads, condiments and dressings.
- Tray Rails offer convenience for your patrons.

See Camwear® Food Pans and Crocks section for more information.

Versa Cart with Dual Tray Rails (VCSWR & VCSWRHD): All orders receive the tray rails in Granite Gray (191) except Bronze (146) receives tray rails in Sandstone (614). To choose a different color tray rail you must order the Versa Cart Without Rails (VCS or VCSHD) and the tray rails (VCS32R) separately.

Connector Colors: Black (110), Bronze (146), Hot Red (158), Navy Blue (186), Kentucky Green (519).

Vinyl Cover Color: Opaque (000).

Sign Holder Color: Clear (152).

Buffet Camchiller® Color: Cold Blue (159).

Divider Bar Colors: White (148), Clear (152).

Well Cover Colors: Black (110), Bronze (146), Hot Red (158), Navy Blue (186), Kentucky Green (519).

Keyboard Tray Color: Black (110).

Crock, Salad Bowl Holders Colors: White (148), Granite Gray (191), Sandstone (614).

Versa Food Bar is covered under U.S. Patent D 615,323 S and D 620,730. All other parts patent pending. Versa Cart is covered under U.S. Patent D 653,830 S. Buffet Camchiller is covered under U.S. Patent D 618,4765 S.

* Items are not NSF Listed.

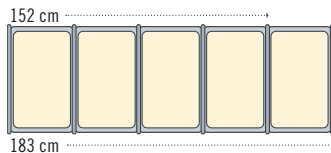

- 183 cm models hold 5 full size Pans with Divider Bars.
- 152 cm models hold 4 full size Pans with Divider Bars.

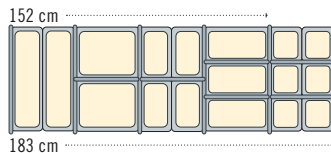

- Fractional Size Pans can be used in many variations with Divider Bars. Mix and match sizes to fit your needs.

Two Salad Bowl Holder models available, SBH18 and SBH15. Crock Holder, CPH3, holds 1,4 and 2,6 L crocks.

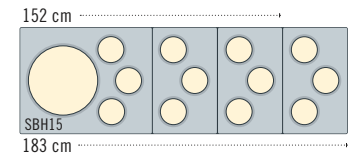
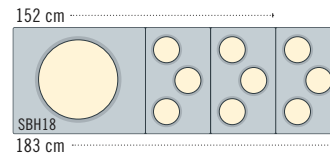

- 183 cm models hold a Salad Bowl Holder and 3 ea. Crock Holders.
- 152 cm models hold a Salad Bowl Holder and 2 ea. Crock Holders.

CODE	DESCRIPTION	OVERALL EXTERIOR DIMENSIONS L x W x H	CASE PACK
VBRR5	Tray Rail for 152 cm - Versa Food Bar / Versa Work Table	134,6 x 29,2 x 11,6 cm	1
VBRR6	Tray Rail for 183 cm - Versa Food Bar / Versa Work Table	167,6 x 29,2 x 11,6 cm	1
VCS32R	Tray Rail for - Versa Cart	71,12 x 29,7 x 12,7 cm	1
VBRTBL	End Table For Versa Food Bar and Work Table	68,58 x 55,88 x 11,43 cm	1
LED54LIGHTPKG*	Lighting Accessory Kit for Versa Food Bar	137 cm	1
VBRCVR5*	Vinyl Cover for 152 cm Versa Food Bar	185,4 x 110,5 x 116,8 cm	1
VBRCVR6*	Vinyl Cover for 183 cm Versa Food Bar	210,8 x 110,5 x 116,8 cm	1
VBRTCVR5*	Vinyl Cover for 152 cm Versa Work Table	177,8 x 85,1 x 53,3 cm	1
VBRTCVR6*	Vinyl Cover for 183 cm Versa Work Table	210,8 x 85,1 x 53,3 cm	1
VCSCVR*	Vinyl Cover for Versa Cart	106,7 x 83,8 x 91,4 cm	1
VBRSHTS*	Versa Food Bar Sign Holder	91,4 x 15,2 x 23,5 cm	1
DIV12	30,5 cm Divider Bars	32,39 cm	3
DIV20	51 cm Divider Bars	53,02 cm	3
CPH3	Crock Holder Holds 1,4 & 2,6 L	33 L x 53 W cm	1
SBH15	Salad Bowl Holder Holds a 38,1 cm Bowl and 3 Crocks	65,5 L x 53 W cm	1
SBH18	Salad Bowl Holder Holds an 45,7 cm Bowl	65,5 L x 53 W cm	1
CPB1220	Buffet Camchiller	46,99 x 32,07 x 10,16 cm	1
VBRWC	Versa Well Cover for Versa Food Bar/Work Table	53,02 x 33,02 x 5,08 cm	1
VCS32KEYT	Versa Cart Keyboard Tray	52,4 x 25,71 x 5,08 cm	1

Versa Food Bar includes Versa Food Bar with and without cabinet.

Table Top Food Bars, Buffet Bars & Sneeze Guards



Table Top Food Bars

- Turn a 122-183 cm table into a double-sided self service buffet or beverage station.
- Thick, foam-insulated well keeps food cold for hours with Buffet Camchillers or ice.
- Drain plug allows for quick and easy clean-up.



4FBRTT Table Top Food Bar

Buffet Bars

- Ideal for holding snacks and cold beverages.
- The Buffet Bar with Sneeze Guard is perfect for single-sided, self-serve buffets.

Food Bar Colors: Black (110), Navy Blue (186), Kentucky Green (519), Hot Red (158).

.....
Crock Holder and Salad Bowl Holders available in White (148), Granite Gray (191), Sandstone (614).
.....



BUF48 and FSG480 can be shipped by parcel carrier.



FSG480 Sneeze Guard

The Free Standing Sneeze Guard is the perfect showcase for salad or dessert items.



BUF48 Buffet Bar Base

Merchandises soft drinks on ice to increase beverage sales.



BBR480 Buffet Bar with Sneeze Guard

CODE	OVERALL EXTERIOR DIMENSIONS	FULL SIZE PAN CAPACITY	WELL INTERIOR DIMENSIONS
Table Top Food Bars			
	L x W x H		L x W x D
6FBRTT	181,6 x 84,5 x 68,6 cm	5	159,7 x 51,1 x 16,5 cm
5FBRTT	161,3 x 84,5 x 68,6 cm	4	127,2 x 51,1 x 16,5 cm
4FBRTT	129,5 x 84,5 x 68,6 cm	3	94,6 x 51,1 x 16,5 cm
Buffet Bars			
	L x W x H		L x W x D
BUF72	171,5 x 61 x 17,8 cm	5	159,7 x 51,1 x 12,7 cm
BUF48	106,2 x 61 x 17,8 cm	3	94,6 x 51,1 x 12,7 cm
Free Standing Sneeze Guards			
	L x W x H		L x W
FSG720	187,6 x 41,9 x 62,2 cm	—	171,5 x 38,7 cm
FSG480	121,9 x 41,9 x 62,2 cm	—	106,7 x 38,7 cm
Buffet Bars w/Sneeze Guard			
	L x W x H		L x W x D
BBR720	187,6 x 61,3 x 62,2 cm	5	159,7 x 51,1 x 12,7 cm
BBR480	121,9 x 61,3 x 62,2 cm	3	94,8 x 51,1 x 12,7 cm

Case Pack: 1

www.cambro.com

Sample Food Bar Set-ups

Visit www.cambro.com/schools for food bar resources, best practices and free posters.



152 cm model



183 cm model



Fresh Food Bars Pre-packaged Breakfast



Rainbow Theme

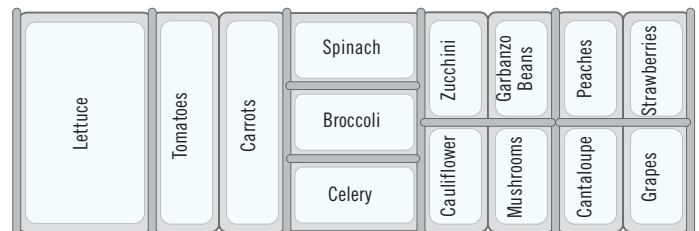

Fresh Food Bars Pre-packaged Lunch



Taco Theme

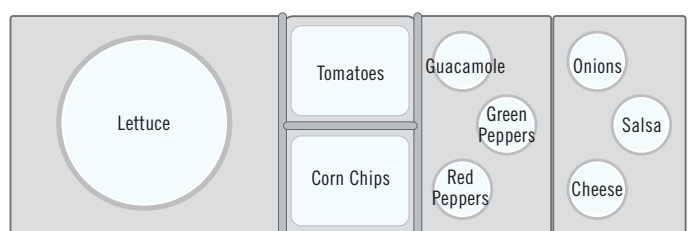

Chili Theme



Burger Theme

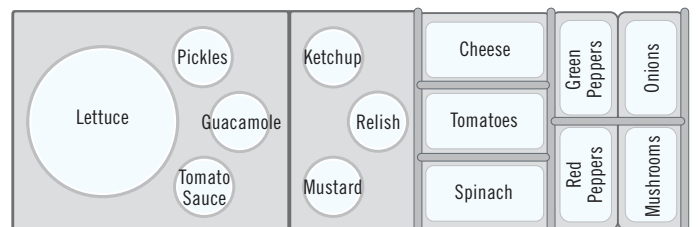

CamKiosk® System – Every Event or Location is an Opportunity For Profits.



- Build sales off premise and in non-traditional locations.
- Two insulated food storage cabinets maintain safe hot or cold food and/or beverage temperatures for hours.
- Use optional well covers to cover food pan wells and increase countertop space.
- Durable, all-weather polyethylene exterior with foam insulation will not crack, dent, bubble, chip, rust or break.
- Heavy duty 15,2 cm casters roll smoothly from kitchen to location then lock in place.



KVC854U
Cart with 4 pan wells & umbrella.

CamKiosk® Carts



Telescoping poles enable canopy to lower 30,5 cm for quick and easy storage.



KVC854C Cart with 4 pan wells & canopy.

Cart Colors

- 186 Navy Blue
- 158 Hot Red

Canopy Color

- 157 Beige

Cart Colors

- 191 Granite Grey
- 192 Granite Green
- 519 Kentucky Green
- 426 Black Base with Granite Grey Top & Doors

Canopy Colors

- 519 Kentucky Green
- Beige/Kentucky Green

Umbrella Color

- Beige/Kentucky Green

Personalize your CamKiosk Cart to promote your brand.

CANOPY TRIM AND TOP PANEL (Charges per side)

- One Color** **
- Two Color** **
- Three Color** **

FRONT DISPLAY PANEL (Cruising Café® panel standard)

- Set Up Charge per Panel** **
- Charge per Color** **

** Contact your Cambro representative for pricing.



Conveniently located, lockable cash box (included) can also be kept in dry storage compartment.



Camchillers® keep cold packaged foods cold during transport and service when placed directly on top of food pan wells or at the top of the CamKiosk's insulated holding cabinet.



Bridge connector joins CamKiosk and hand sink to create greater contiguous workspace and under-counter storage.



4 well top



6 well top

CODE	FULL SIZE PAN WELLS	OVERALL DIMENSIONS L x W x H
CamKiosk Carts		
KVC854	4	216 x 85 x 179 cm
KVC854C	4	216 x 85 x 239 cm
KVC854U	4	216 x 154 x 251 cm
KVC856	6	216 x 85 x 179 cm
KVC856C	6	216 x 85 x 239 cm
KVC856U	6	216 x 154 x 251 cm
C: Canopy	U: Umbrella	

Holding Capacity Per Compartment

Two holding cabinets store hot or cold food in Gastronorm Food Pans with Covers.

- 12 GN $\frac{1}{2}$ full size 10 cm deep pans or
- 8 GN $\frac{1}{2}$ full size 15 cm deep pans or
- 6 GN $\frac{1}{2}$ full size 20 cm deep pans.
- 4 each 2025 Camtrays or
- 8 each 3253 Camtrays.

CODE	DESCRIPTION	DIMENSIONS L x W x H	CASE PACK
Optional Accessories			
CB1220	Cutting Board	53,5 x 33,5 x 1,3 cm	1
CP814	20,32 x 35,56 cm Camchiller®	3,81 x 20,32 x 35,56 cm	1
CP1220	Camchiller	53 x 33 x 3,8 cm	1
KMC24	Bridge Connector	82 x 58,5 x 97,5 cm*	1
WCR1220	Well Cover	53,5 x 33 x 5 cm	1
1600DIV	ThermoBarrier® Insulated Shelf	53 x 33,5 x 3,8 cm	2
C: Canopy	U: Umbrella		

* Assembled dimensions for KMC24.

Well Cover Colors: Black (110), Hot Red (158), Navy Blue (186), Kentucky Green (519), Granite Grey (191), Granite Green (192).

15,24 cm Casters: 2 fixed, 2 swivel, 2 with brake.

Cutting Board Color: White (148).
Camchiller Color: Cold Blue (159).
ThermoBarrier Color: Slate Blue (401).



Camchiller & ThermoBarrier

CamKiosk® Hand Sink Cart, Work Station & Equipment Stand

Hand Sink Cart

- Self-contained, electric hand washing system can be used alone or with CamKiosk Cart.
- Run hot and cold water for up to 70 hand washings.
- Includes: double sink, two 19 L fresh water tanks, two 28,5 L waste-water bins, hand soap dispenser and paper towel roll holder.
- Durable polyethylene will not crack, dent, bubble, chip or break.
- Hand Sink Cart is designed for hand washing. It contains no filter for purifying water for drinking.
- Faucet is compliant with lead-free regulations.

Colors: Granite Grey (191), Granite Green (192), Navy Blue (186), Hot Red (158), Green (519), Black Base with Granite Grey Top & Doors (426).

15,2 cm Casters: 2 fixed, 2 swivel, 2 with brake.

Hand Sink Cart is covered by U.S. Patent D 409,732 & by Patent 6,173,458 B1.

† 220 volt model includes CEE7 type Euro plug.



Water pump only.



Water heater and water pump draw a maximum of 11,25 amps and 0,7 amps, respectively. Hand Sink Cart electrical system runs on an average 10 amps.

ADA faucet available. Contact Cambro Customer Service for information.

Hand Sink Cart is designed for hand washing. It contains no filter for purifying water for drinking.

CODE	VOLTAGE	DIMENSIONS L x W x H
KSC402	110	103 x 83 x 116 cm
KSC402220†	220	103 x 83 x 116 cm

Case Pack: 1

Work Station

- Use to merchandise menu items, additional work space or to complete sales transactions.
- Large dry storage cabinet below is perfect for holding supplies.
- Extremely durable all-weather polyethylene will not crack, dent, bubble, chip, rust or break.

Colors: Granite Grey (191), Granite Green (192), Navy Blue (186), Hot Red (158), Green (519), Black Base with Granite Grey Top & Doors (426).

15,2 cm Casters: 2 fixed, 2 swivel, 2 with brake.

Top work area dimensions: 57,2 x 66 cm



Shown with optional cutting board and paper towel roll dispenser.

CODE	DESCRIPTION	DIMENSIONS L x W x H
KWS40	Work Station	103 x 84 x 116 cm
CB1220	Cutting Board	53,5 x 33,5 x 1,3 cm

Case Pack: 1

Equipment Stand

- Perfect for self-serve stations, prep areas or cash register service.
- Counter and side openings for electrical cords and cables.
- Durable, lightweight polyethylene will not crack, dent, bubble, chip, rust or break.
- No assembly required.

Color: Black (110).

12,7 Casters: 2 fixed, 2 swivel with brake.

* Special order item not carried in stock – non-returnable.







Cutaway chair area gives ample space for comfortable seating.

CODE	DESCRIPTION	OVERALL DIMENSIONS W (W/TRAY RAILS) x D x H
ES28	Stand only	71 x 71 x 99 cm
ES28RL*	Stand w/Rails on right and left sides of drawer	112 x 71 x 99 cm

Height includes casters.

Camcruiser® Vending Carts

- Add revenue opportunities away from the kitchen or cafeteria and reduce wait times.
- Durable polyethylene will not crack, dent, bubble, chip, rust or break.
- Display panel can be personalized with a custom logo or message.
- Larger models CVC724 & CVC72 have insulated food storage compartments and full-size food pan wells.
- The compact CVC55 has two open storage compartments, a single food pan well and cutting board.

Cart Color	Umbrella Color
Black (110)	
Hot Red (158)	
Kentucky Green (519)	
Granite Grey (191)	
Granite Green (192)	



CVC724
Open Compartment
Dimensions:
W 33,5 x D 61,5 x H 34 cm

CVC72 & CVC724



CVC724 Four full size food pan wells. Replace with cutting boards or well covers to create additional work space.



CVC72



CVC72 One full size food pan well and 2 larger merchandising wells.



Open holding compartment conveniently stores cash box and tray.

CODE	CVC724	CVC72	CVC55
OVERALL DIMENSION*	L 189 x W 81 x H 239 cm	L 189 x W 81 x H 239 cm	L 140 x W 80 x H 238 cm
WORK COUNTER HEIGHT	93 cm	93 cm	101 cm
COUNTER WELLS HOLD	4 GN $\frac{1}{2}$	Center well, 1 GN $\frac{1}{2}$ 2 outer wells, L 56 x W 39 x D 15 cm	1 GN $\frac{1}{2}$
CLOSED COMPARTMENT CAPACITY (EACH)	2 GN $\frac{1}{2}$ -20 cm + 2 GN $\frac{1}{2}$ -6,5 cm deep pans or 4 GN $\frac{1}{2}$ -15 cm deep pans or 6 GN $\frac{1}{2}$ -10 cm deep pans or 8 GN $\frac{1}{2}$ -6,5 cm deep pans or 4 each 2025 Camtrays or 8 each 3253 Camtrays	2 full size 20 cm + 2 GN $\frac{1}{2}$ -6,5 cm deep pans or 4 GN $\frac{1}{2}$ -15 cm deep pans or 6 GN $\frac{1}{2}$ -10 cm deep pans or 8 GN $\frac{1}{2}$ -6,5 cm deep pans or 4 each 2025 Camtrays or 8 each 3253 Camtrays	—
OPEN COMPARTMENT CAPACITY	1 cash drawer and 1 GN $\frac{1}{2}$ -15 cm deep pan or 2 GN $\frac{1}{2}$ -10 cm deep pans or 3 GN $\frac{1}{2}$ -6,5 cm deep pans	1 cash drawer and 1 GN $\frac{1}{2}$ -15 cm deep pan or 2 GN $\frac{1}{2}$ -10 cm deep pans or 3 GN $\frac{1}{2}$ -6,5 cm deep pans	—
UMBRELLA DIAMETER	183 cm	183 cm	152 cm
CASTERS	20,3 cm - 4 swivel with brake	20,3 cm - 4 swivel with brake	15,2 cm - 2 fixed, 2 swivel with brake
CASH DRAWER	Yes	Yes	—
MENU BOARD	Yes	Yes	—
DISPLAY PANEL	Yes	Yes	Yes
MOLDED IN HANDLES	2	2	1

* Includes Umbrella. Serving counter height is 130 cm.

Camcruiser® Vending Carts



CVC55

Unit ships with umbrella and cutting board. Front display panel can be personalized.

- Cutting Board Color:** White (148).
- Camchiller Color:** Cold Blue (159).
- Divider Bar Colors:** White (148), Clear (135).
- Retainer Strap Color:** Black (110).
- ThermoBarrier® Color:** Slate Blue (401).
-
- Well Cover Color matches cart.**
-
- CVC55 is covered by U.S. Patent D 362,102.
-



Camchiller, ThermoBarrier, and Divider Bar.



Compartments are open for storage and easy access to equipment and supplies for your vending operations. Optional retainer strap is sold separately.

Left Compartment Dimensions:
W 61,5 x D 72,5 x H 70 cm
Right Compartment Dimensions:
W 54,5 x D 72,5 x H 70 cm



Pizza Camcruiser



Sandwich Camcruiser



Hot Dog Camcruiser



Soft Drink Camcruiser

Display Panel Personalization

Provide complete, finished, camera-ready artwork and indicate positioning on display panel. Ink colors must be specified. Choose 1-4 colors.

Size of imprinting area:
CVC72 and CVC724
W 53,5 x H 74,5 cm
CVC55 W 112,5 x H 74,5 cm.

Artist's fee of ** net/hour will be charged to any order submitted without camera-ready artwork.

Cambro will contact you prior to completing any work if this fee will be charged.

Set up charge of ** net per design, plus ** net per color.

Allow for three week production lead time once final proofs are approved.

* CVC72 and CVC724 - Campus Cuisine display panel standard with all orders unless custom personalization requested.

** Contact your Cambro representative for pricing.

CVC55



Set up with full and fractional size food pans and divider bars to increase product offerings.



Electrical or soda line conveniently drops through 10 x 17 cm opening in counter. Cover is standard with cart.

CODE	DESCRIPTION	FITS	OVERALL DIMENSIONS L x W x H
Optional Accessories			
CB1220	Cutting Board	CVC724, CVC72, CVC55	53,5 x 33,5 x 1,3 cm
CP1220	Camchiller®	CVC724, CVC72	53 x 33 x 3,8 cm
DIV12	Divider Bar	CVC724, CVC72, CVC55	32,5 cm long
WCR1220	Well Cover	CVC724, CVC72, CVC55	53,5 x 33 x 5 cm
730STP	Retainer Strap	CVC55	—

DIV12 Case Pack: 3 - 1200DIV Case Pack: 2 - All Others Case Pack: 1
Camchiller, ThermoBarrier & Divider Bar are NSF listed.

Booster Seats & Versa Organizers

Booster Seats

- Contoured seat, high sides, wide square base and non-skid surface for toddler comfort and safety.
- Choose from dual or single seat models, with or without strap.
- Durable polyethylene will not crack, dent, bubble, chip, rust or break.

Colors: Black (110), Dark Brown (131), Coffee Beige (157), Navy Blue (186), Kentucky Green (519), Hot Red (158).

No broken cartons on 4 pack.



A Single Seat

B Dual Seat

DIMENSIONS	W x D x H
Overall	29,5 x 28,6 x 20,6 cm
Seat Base	22,2 x 24,7 cm
Inside Seat	24,1 x 24,7 x 10,2 cm

CODE	100BC	100BC1	100BCS
Single Seat			
DESCRIPTION	no strap	no strap	with strap
CASE PACK	4	1	4



DIMENSIONS	W x D x H
Overall	31,6 x 31,1 x 23,8 cm
Seat Base A	31,6 x 31,1 cm
Seat Base B	32,1 x 30,8 cm
Inside Seat A	21 x 24,4 x 8,3 cm
Inside Seat B	27,3 x 27,3 x 12,1 cm

CODE	200BC	200BC1	200BCS
Double Seat			
DESCRIPTION	no strap	no strap	with strap
CASE PACK	4	1	4

Booster seats are available with or without straps.

Versa Organizers

- Use to store non-perishable condiments, disposable ware and napkins.
- Hold bins in 2 x 3, 2 x 4, 3 x 3, or 3 x 4 arrangements.
- Made of seamless, one-piece polyethylene.
- Set on flat surface or wall mount each bin holds up to 4,5 kg.
- Easy to assemble and easy to clean.

Bins Only Colors: Coffee Beige (157), Dark Brown (131), Black (110), Slate Blue (401), Speckled Grey (480).

Versa Line Combined Pack Bins & Racks.

Colors: Dark Brown (131), Black (110), Speckled Grey (480).



12RS12 Versa Organizer shown mounted on wall.



Bins sold separately (5412CBP) or as combined packs.



8RS8



6RS6

CODE	DESCRIPTION	PRODUCT DIMENSIONS	CASE PACK
Bins		W x D x H	
5412CBP		13 x 30,5 x 11 cm	12
Versa Line Combined Pack		L x D x H (complete unit)	
12RS12	Rack w/12 bins	64,8 x 54,3 x 36,2 cm	1
9RS9	Rack w/9 bins	51,1 x 54,3 x 36,2 cm	1
8RS8	Rack w/8 bins	64,8 x 48,8 x 24,1 cm	1
6RS6	Rack w/6 bins	51,1 x 48,8 x 24,1 cm	1

Portable Cambars®

- Stylish, portable beverage bars for hosting in any environment.
- Select from three systems: economy for bottle and can service, partial or complete soda gun set up systems for pre-mix (canisters) or post-mix (bag-in-box).
- Available in three sizes:
 - Large BAR730 is perfect for banquets and cocktail events.
 - Mid-size BAR650 fits into standard elevators and is ideal for small to mid-size functions.
 - Small BAR540 is ultra portable for off-premise use and events with limited space.
- All models include speed rail and 36,3 kg capacity ice sink with cover. BAR540 sink comes uncovered.
- Impact-resistant, waterproof polyethylene will not crack, dent, bubble, chip, rust or break.
- Lightweight and portable.
- Easy to take apart and clean, easy to set up.





BAR650 Shown in Standard Decor Granite Sand (194).



BAR650DS Shown in Designer Decor Sedona (668).

THREE SIZES

THREE SYSTEMS

	ECONOMY SYSTEM	BASIC SYSTEM	COMPLETE SYSTEM
<p>Large BAR730 Models</p> 	<ul style="list-style-type: none"> • For Bottle, Can, or Mixer Service. • Includes Ice Bin & Speed Rail. • Standard or Designer Decor. 	<ul style="list-style-type: none"> • Partially Equipped for Post or Pre-Mix Soda Service. • Operator Completes Installation. • Standard or Designer Decor. 	<ul style="list-style-type: none"> • Completely Factory Equipped for Post or Pre-Mix Soda Service. • Standard or Designer Decor.
<p>Mid-Size BAR650 Models</p> 	<p>Standard Decor BAR650</p> <p>Designer Decor BAR650DS</p>	<p>Standard Decor BAR650CP</p> <p>Designer Decor BAR650DSCP</p>	<p>Standard Decor BAR650PM, BAR650PMT, BAR650PMT220, BAR650DX</p> <p>Designer Decor BAR650DSPM, BAR650DSPMT, BAR650DSPMT2, BAR650SDX</p>
<p>Small BAR540 Models</p> 	<p>Standard Decor BAR540</p> <p>Designer Decor BAR540DS</p>	N/A	N/A

Portable Cambars® Packages & Accessories

Standard Equipment, Soda Guns, Standard and Designer Decor Packages

STANDARD DECOR EQUIPMENT	ECONOMY			BASIC SYSTEM			COMPLETE SYSTEM POST-MIX (Bag in Box)				COMPLETE SYSTEM PRE-MIX (Canisters)	
	BAR540	BAR650	BAR730	BAR650CP	BAR730CP	BAR650PM	BAR650PMT	BAR730PM	BAR730PMT	BAR650DX	BAR730DX	
DESIGNER DECOR EQUIPMENT	BAR540DS	BAR650DS	BAR730DS	BAR650DSCP	BAR730DSCP	BAR650DSPM	BAR650DSPMT	BAR730DSPM	BAR730DSPMT	BAR650SDX	BAR730SDX	
Bag In Box Syrup Pumps						3 ea	3 ea	6 ea	6 ea			
Bag In Box Rack (Holds 3ea Boxes)						1	1	2	2			
Carbonator						YES	YES	YES	YES			
CO ₂ Regulator						YES	YES	YES	YES	YES	YES	
CO ₂ Clamp & Chain				YES	YES	YES	YES	YES	YES	YES	YES	
Ice Sink 8 - Circuit Cold Plate				YES	YES	YES	YES	YES	YES	YES	YES	
Ice Sink Cover	Sink only	YES	YES	YES	YES	YES	YES	YES	YES	YES	YES	
Retainer Strap		1	2	1	2	1	1	2	2	1	2	
Soda Gun (5, 6 or 8 buttons)						5	5	8	8	5	6	
Speed Rail (5 or 7 bottle)	5	7	7	7	7	7	7	7	7	7	7	
Water Pump							YES		YES			
Water Tank							YES		YES			
Water Line Hook Up (city source)						YES		YES				
Waste Water Bin		YES	YES	YES	YES	YES	YES	YES	YES	YES	YES	
Vinyl Cover	YES	YES	YES	YES	YES	YES	YES	YES	YES	YES	YES	

Casters: All BAR540 Models - Four 12,7 cm swivel, two with brake. All BAR650 and BAR730 Models - Four 15,24 cm swivel, two with brake.

Soda Guns by Wunder-Bar®

- Fast, low foaming delivery.
- Two year warranty from Wunder-Bar.
- Includes holster with overflow drain.
- Available with complete systems only.



Post-Mix 8 Button
(BAR730 Complete System)



Post-Mix 5 Button
(BAR650 Complete System)



Pre-Mix 6 Button
(BAR730 Complete System)



Pre-Mix 5 Button
(BAR650 Complete System)

Standard Decor Colors BAR540, BAR650, BAR730



110
Black

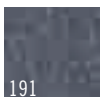

191
Granite Gray

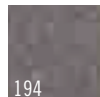

194
Granite Sand

BAR650, BAR730 Only

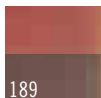

189
Two-Tone Brown
Mahogany

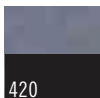

420
Granite Gray w/
Black Base

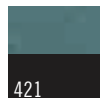

421
Granite Green
w/ Black Base

BAR540 Only



131
Dark Brown



157
Coffee Beige



401
Slate Blue



180
Gray

Designer Decor BAR650, BAR730 Only



667
Manhattan

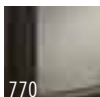

770
Chicago

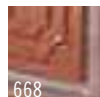

668
Sedona

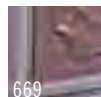

669
Carmel

BAR540 Designer Decor color options are listed with BAR540 details.

Exclusive Cold Plate

- Patented "roof top" design allows for melted ice water to drain into the bottom of the ice sink and into the waste-water bin.
- Circuit exposure through cold plate chills liquids dispensed from the soda gun.



Cold Plate is covered under
U.S. Patent 5,743,602.

Optional Accessories for CamBars

CODE	DESCRIPTION
650WS	Wire Shelf for BAR650's
730WS	Wire Shelf for BAR730's
730SR	7 Bottle Speed Rail
BAR54SR	5 Bottle Speed Rail

Case Pack: 1

Large CamBars® – Complete System BAR730

- Fully Equipped For Service, Post Or Pre-Mix.
- Factory Installed Soda System With Soda Gun.
- With Or Without Water Tank (Post-Mix Only).

COMPLETE SYSTEM BAR730 – LARGE MODEL

Post-Mix System For 18,9 L Bag In Box Syrup
(Holds up to 6 bag in the box and 1 CO₂ tank.)

Standard Decor

Unit Dimensions: L 184,8 x W 66 x H 121,9 cm

CODE	BAR730PM	BAR730PMT	BAR730PMT220
VOLTS	110	110	220
WATER TANK	NO	YES	YES
UNIT WEIGHT	147 kg	156 kg	156 kg

Designer Decor

Unit Dimensions: L 197,2 x W 72,4 x H 120,7 cm

CODE	BAR730DSPM	BAR730DSPMT	BAR730DSPMT2
VOLTS	110	110	220
WATER TANK	NO	YES	YES
UNIT WEIGHT	164,2 kg	173,3 kg	173,3 kg

COMPLETE SYSTEM BAR730 – LARGE MODEL

Pre-Mix System for 18,9 L Soda Canisters
(Holds up to 7 canisters and 1 CO₂ tank.)

Standard Decor

Unit Dimensions: L 184,8 x W 66 x H 121,2 cm

CODE	BAR730DX
UNIT WEIGHT	120 kg

Designer Decor

Unit Dimensions: L 197,2 x W 72,4 x H 120,7 cm

CODE	BAR730SDX
UNIT WEIGHT	124,3 kg



STANDARD EQUIPMENT FOR BAR730PM & BAR730DSPM:

1 post-mix soda gun (8 buttons), 1 sealed-in cold plate with 8 circuits, 1 carbonator, 1 CO₂ regulator gauge and tubing, hose and lines, 1 CO₂ chain, 2 stainless steel syrup box racks, 6 bag-in-box pumps, 1 speed rail (7 bottle), one 36,3 kg capacity ice sink, 1 ice sink cover, 1 waste-water bin, 2 retainer straps, line for city water hook-up, four 15,24 cm swivel casters, 2 with brake and 1 vinyl cover.

STANDARD EQUIPMENT FOR BAR730PMT, BAR730DSPMT, BAR730PMT220 & BAR730DSPMT2:

* Includes all of the above plus: 1 each 64,3 L water tank & 1 each water pump. Line for city water hook-up not included.



STANDARD EQUIPMENT FOR BAR730DX & BAR730SDX:

1 pre-mix soda gun (6 buttons), 1 sealed-in cold plate with 8 circuits, 1 CO₂ chain, 1 speed rail (7 bottle), one 36,3 kg capacity ice sink, 1 ice sink cover, 1 waste-water bin, 2 retainer straps, four 15,24 cm swivel casters, 2 with brake and 1 vinyl cover.

Large Mobile CamBars® – Basic and Economy Systems

BASIC SYSTEM BAR730 – LARGE MODEL

Standard Decor

Unit Dimensions: L 184,8 x W 66 x H 121,9 cm

CODE	BAR730CP
UNIT WEIGHT	115,2 kg

Designer Decor

Unit Dimensions: L 197,2 x W 72,4 x H 120,7 cm

CODE	BAR730DSCP
UNIT WEIGHT	132,4 kg

STANDARD EQUIPMENT FOR BAR730CP & BAR730DSCP:

1 sealed-in cold plate with 8 circuits, 1 CO₂ chain, 1 speed rail (7 bottle), one 36,3 kg capacity ice sink, 1 ice sink cover, 1 waste-water bin, 2 retainer straps, four 15,24 cm swivel casters, 2 with brake and 1 vinyl cover.



BAR730DS
(Shown with four optional wire racks; see details under Portable CamBar Packages and Accessories.)

ECONOMY SYSTEM BAR730 – LARGE MODEL

Standard Decor

Unit Dimensions: L 184,8 x W 66 x H 121,9 cm

CODE	BAR730
UNIT WEIGHT	100 kg

Designer Decor

Unit Dimensions: L 197,2 x W 72,4 x H 120,7 cm

CODE	BAR730DS
UNIT WEIGHT	105 kg

STANDARD EQUIPMENT FOR BAR730 & BAR730DS:

1 speed rail (7 bottle), one 36,3 kg capacity ice sink, 1 ice sink cover, 1 waste-water bin, 2 retainer straps, four 15,24 cm swivel casters, 2 with brake and 1 vinyl cover.



BAR730DS
Shown in Designer Decor Chicago (770).



Mid-Size Mobile Cambars® – Complete System BAR650

- Fully equipped for service, post or pre-mix.
- Factory installed soda system with soda gun.
- With or without water tank (post-mix only).

COMPLETE SYSTEM BAR650 – MID-SIZE MODEL

Post-Mix System For 18,9 L Bag In Box Syrup
(Holds up to 3 bag-in-boxes and 1 CO₂ tank.)

Standard Decor

Unit Dimensions: L 171,5 x W 72,4 x H 120,7 cm

CODE	BAR650PM	BAR650PMT*	BAR650PMT220*
VOLTS	110	110	220
WATER TANK	NO	YES	YES
UNIT WEIGHT	152 kg	152 kg	152 kg

Designer Decor

Unit Dimensions: L 171,5 x W 72,4 x H 120,7 cm

CODE	BAR650DSPM	BAR650DSPMT*	BAR650DSPMT2*
VOLTS	110	110	220
WATER TANK	NO	YES	YES
UNIT WEIGHT	155,1 kg	164,2 kg	164,2 kg



STANDARD EQUIPMENT FOR BAR650PM, BAR650DSPM:

1 post-mix soda gun (5 buttons), 1 sealed-in cold plate with 8 circuits, 1 carbonator, 1 CO₂ regulator gauge and tubing, hose and lines, 1 CO₂ chain, 1 stainless steel bag in box racks, 3 bag in box pumps, 1 speed rail (7 bottle), one 36,3 kg capacity ice sink, 1 ice sink cover, 1 waste-water bin, 2 retainer straps, line for city water hook-up, four 15,24 cm swivel casters, 2 with brake and 1 vinyl cover.

STANDARD EQUIPMENT FOR BAR650PMT, BAR650DSPMT, BAR650PMT2 & BAR650DSPMT2

* Includes all of the above plus: 1 each 64,3 L water tank & 1 each water pump. Line for city water hook-up not included.

COMPLETE SYSTEM BAR650 – MID-SIZE MODEL

Pre-Mix System for 18,9 L Soda Canisters
(Holds up to 5 canisters and 1 CO₂ tank.)

Standard Decor

Unit Dimensions: L 171,5 x W 72,4 x H 120,7 cm

CODE	BAR650DX
UNIT WEIGHT	129,3 kg

Designer Decor

Unit Dimensions: L 171,5 x W 72,4 x H 120,7 cm

CODE	BAR650SDX
UNIT WEIGHT	132,4 kg



STANDARD EQUIPMENT FOR BAR650DX & BAR650SDX:

1 pre-mix soda gun (5 buttons), 1 sealed-in cold plate with 8 circuits, 1 CO₂ chain, 1 speed rail (7 bottle), one 36,3 kg capacity ice sink, 1 ice sink cover, 1 waste-water bin, 1 retainer strap, four 15,24 cm swivel casters, 2 with brake and 1 vinyl cover.

Mid And Small Size Mobile Cambars® – Basic And Economy Systems

BASIC SYSTEM BAR650 – MID-SIZE MODEL

Standard Decor

Unit Dimensions: L 171,5 x W 72,4 x H 120,7 cm

CODE	BAR650CP
UNIT WEIGHT	119,7 kg

Designer Decor

Unit Dimensions: L 171,5 x W 72,4 x H 120,7 cm

CODE	BAR650DSCP
UNIT WEIGHT	122,9 kg



BAR650DSCP
(Shown with two optional wire racks; see details under Portable CamBar Packages & Accessories.)

STANDARD EQUIPMENT FOR BAR650CP & BAR650DSCP:

1 sealed-in cold plate with 8 circuits, 1 CO₂ chain, 1 speed rail (7 bottle), one 36,3 kg capacity ice sink, 1 ice sink cover, 1 waste-water bin, 1 retainer strap, four 15,24 cm swivel casters, 2 with brake and 1 vinyl cover.

ECONOMY SYSTEM BAR650 – MID-SIZE MODEL

For Bottle, Can Or Mixer Service

Standard Decor

Unit Dimensions: L 171,5 x W 72,4 x H 120,7 cm

CODE	BAR650
UNIT WEIGHT	83,9 kg

Designer Decor

Unit Dimensions: L 171,5 x W 72,4 x H 120,7 cm

CODE	BAR650DS
UNIT WEIGHT	87,1 kg



BAR650DSCP
(Shown with two optional wire racks; see details under Portable CamBar Packages & Accessories.)

STANDARD EQUIPMENT FOR BAR650 & BAR650DS:

1 speed rail (7 bottle), one 36,3 kg capacity ice sink, 1 ice sink cover, 1 waste-water bin, 1 retainer strap, four 15,24 cm swivel casters, 2 with brake and 1 vinyl cover.

ECONOMY SYSTEM BAR540 – SMALL MODEL

Standard Decor

Unit Dimensions: L 137,2 x W 65,7 x H 117,2 cm

CODE	BAR540
UNIT WEIGHT	52,2 kg

Designer Decor

Unit Dimensions: L 137,2 x W 65,7 x H 117,2 cm

CODE	BAR540DS
UNIT WEIGHT	54,4 kg



BAR540DS

Designer Decor Colors

BAR540 Only

- Black Base w/ Coal Counter
670
- Granite Gray Base w/ Slate Gray Counter
671
- Granite Sand Base w/ Cocoa Counter
672

STANDARD EQUIPMENT BAR540 & BAR540DS:

1 speed rail (5 bottle), one 36,3 kg capacity ice sink, four 12,7 cm swivel casters, 2 with brake and 1 vinyl cover.

Slidinglid™ Ice Caddies

- Polyethylene body and thick foam insulation hold ice for days.
- Rugged, all-weather exterior will not crack, dent, bubble, chip, rust or break.
- Unique sliding lid slides back and under during use, reducing risk of cross-contamination.
- Recessed well and drain shelf keep ice out of water, extending holding times.
- Recessed, molded-in handles ease lifting and maneuvering.
- No assembly required.



ICS125L
(Short)



ICS100L4S
(Short)



ICS100L
(Short)

These units feature a slant top sliding lid, hold up to 45 kg. of ice and fit under prep/catering tables, counters or the CamKiosk Bridge.



ICS125LB
(Short) Shown with Rear Easy Wheels.

Colors: Black (110), Slate Blue (401), Dark Brown (131), Coffee Beige (157), Grey (180), Granite Grey (191), Granite Green (192).

SlidingLid Ice Caddies ICS125L, ICS125L4S, ICS125LB are covered by US Patent D 468,071 S. SlidingLid Ice Caddies ICS100L and ICS100L4S are covered by US Patent D 424,883.



ICS175T
(Tall)



ICS175TB
(Tall) Shown with Rear Easy Wheels.

Caster Descriptions

(Refers to caster type in chart)

A: 2 fixed, 2 swivel, 1 with brake

A1: 2 swivel, 2 with brakes

B: 4 swivel, 1 with brake

C: 2 swivel, 1 with brake,

2 20,3 cm Easy Wheels

D: 2 swivel, 1 with brake,

2 25,4 cm Easy Wheels

E: 2 swivel, 1 with brake,

2 25,4 cm Wide Easy Wheels



ICS200TB
(Tall) Shown with Rear Wide Easy Wheels.



CODE	CAPACITY IN KG	EXTERIOR DIMENSIONS W x D x H	CASTER TYPE
Short			
ICS100L	46	57 x 77 x 73 cm	A1
ICS100L4S	46	57 x 77 x 73 cm	B
ICS125L	57	58,5 x 80 x 74,5 cm	A
ICS125LB	57	58,5 x 80 x 74,5 cm	C
ICS175L	80	61 x 95,5 x 74,5 cm	A
ICS175LB	80	61 x 95,5 x 74,5 cm	D
Tall			
ICS125T	57	58,5 x 80 x 88 cm	A
ICS175T	80	58,5 x 86,5 x 95,5 cm	A
ICS175TB	80	58,5 x 86,5 x 95,5 cm	D
ICS200TB	91	58,5 x 86,5 x 100,5 cm	E

Case Pack: 1



Warewashing, Handling & Storage



Camrack® 4-in-1 Warewashing System

Camdollies®

Utility Trucks

Tray & Dish Cart / Tray & Silverware Cart

S-Series Adjustable Dish Caddy

Versa Dish Caddies, Dish Caddies, Adjustable Tray & Dish Cart

Cambox® Bus Boxes

KD Service Cart and KD Utility Cart

Service Carts

Camrack® 4-in-1 Warewashing System

The Camrack System will protect glassware and keep it clean until the next event, eliminating the need for rewashing.

Efficient Washing



Open inside compartments provide thorough circulation of water and cleaning solutions and promote quick and thorough drying.

Long-lasting polypropylene Camracks are built to withstand chemicals and high temperatures up to 200°F (93°C).

Sanitary Storage



Closed outer walls keep fingers and contaminants out and reduce risk of breakage and injury. The Camrack cover and Camdolly make this system completely enclosed. Glassware stays clean when in storage, so operators will only have to wash items once.

Inventory Control



A variety in base rack colors help identify at a glance both contents and quantity per rack. Available in 10 colors.

Safe, Sanitary Transportation



Camracks can be transported across large campuses or to off-site locations in one single unit.

Easy to grip handles and smooth overlapping sides facilitate safe handling.

Camrack Cover Seals from the Top and Camdolly® Seals from the Bottom.

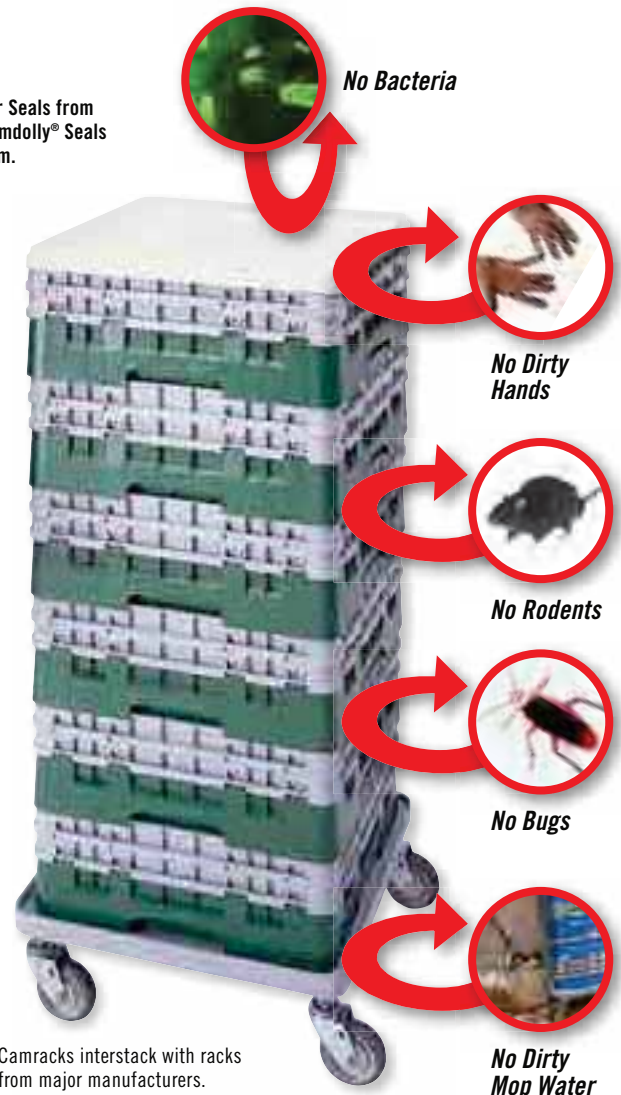

Camracks interstack with racks from major manufacturers.

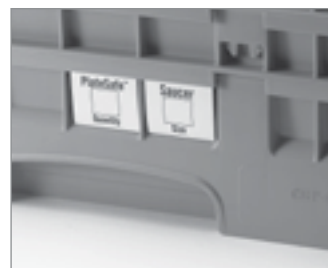

Content labeling options include one-color custom hot stamping or pre-printed clips that are added at factory during assembly.



Camracks are covered by one or more of the following patents: Full Base Dish Rack D 412,607. Half Base Dish Rack D 404,176. Half Dish Rack Extender D 400,321. Enlarged Dish Rack Extender D 399,614. Dish Rack with Extender 5,934,486 Utility Patent. Pronged Base Dish Rack D 403,472.

Full Size Camracks® for Stemware & Tumblers

These racks offer complete protection for all your delicate and valuable stemware and tumblers, from washing and handling to stacking, storing and transporting.

Choose the correct dishrack:

1. Measure the maximum diameter of your glass (stemware or tumbler) to determine the number of compartments.
2. Measure the maximum height of your glass (stemware or tumbler) to the top edge of the rim to determine the compartment height.

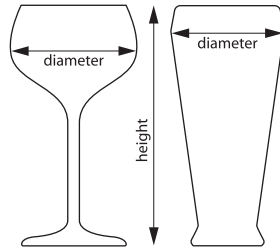

Camrack Sizing Guides are available at www.cambro.com/mycamracks.

14,9 cm
MAXIMUM DIAMETER

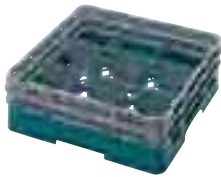

9 COMPARTMENT

MAXIMUM HEIGHT	9,2 cm	13,3 cm	17,4 cm	21,5 cm	25,7 cm	29,8 cm
CODE	9S318	9S434	9S638	9S800	9S958	9S1114
CASE PACK	5	4	3	2	2	2
EXT. RACK HEIGHT	14,3 cm	18,4 cm	22,5 cm	26,7 cm	30,8 cm	34,9 cm

11,11 cm
MAXIMUM DIAMETER

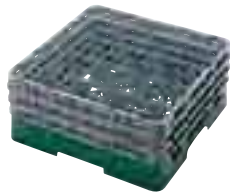

16 COMPARTMENT

MAXIMUM HEIGHT	9,2 cm	11,4 cm	13,3 cm	15,5 cm	17,4 cm	19,6 cm
CODE	16S318	16S418**	16S434	16S534**	16S638	16S738**
CASE PACK	5	5	4	4	3	3
EXT. RACK HEIGHT	14,3 cm	14,3 cm	18,4 cm	18,4 cm	22,5 cm	22,5 cm
MAXIMUM HEIGHT	21,5 cm	23,8 cm	25,7 cm	27,9 cm	29,8 cm	32 cm
CODE	16S800	16S900**	16S958	16S1058**	16S1114	16S1214**
CASE PACK	2	2	2	2	2	2
EXT. RACK HEIGHT	26,7 cm	26,7 cm	30,8 cm	30,8 cm	34,9 cm	34,9 cm

Base Rack Colors:

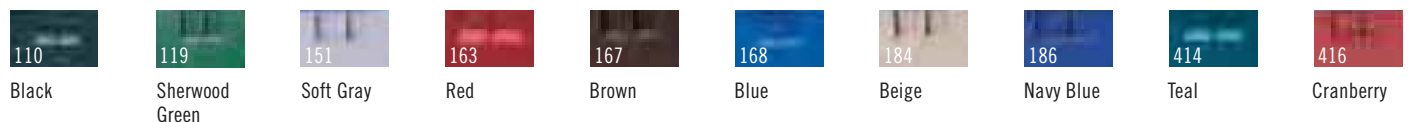

Extender Color: Soft Grey (151). ** Compartment Extenders cannot be added. Personalization available. See Camrack personalization and color coding page. For a more accurate color representation, call your sales rep for actual color chips. Contact Customer Service for all special orders.

Full Size Camracks® for Stemware & Tumblers

Match a glass to a rack at www.cambro.com/Reference_Guides.

20 COMPARTMENT

9,84 cm
MAXIMUM DIAMETER



MAXIMUM HEIGHT	9,2 cm	13,3 cm	17,4 cm	21,5 cm	25,7 cm	29,8 cm
CODE	20S318	20S434	20S638	20S800	20S958	20S1114
CASE PACK	5	4	3	2	2	2
EXT. RACK HEIGHT	50 x 50 x 14,3 cm	50 x 50 x 18,4 cm	50 x 50 x 22,5 cm	50 x 50 x 26,7 cm	50 x 50 x 30,8 cm	50 x 50 x 34,9 cm

25 COMPARTMENT

8,7 cm
MAXIMUM DIAMETER

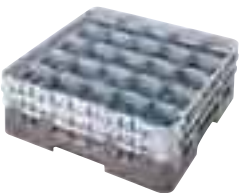

MAXIMUM HEIGHT	9,2 cm	11,4 cm	13,3 cm	15,5 cm	17,4 cm	19,6 cm
CODE	25S318	25S418**	25S434	25S534**	25S638	25S738**
CASE PACK	5	5	4	4	3	3
EXT. RACK HEIGHT	14,3 cm	14,3 cm	18,4 cm	18,4 cm	22,5 cm	22,5 cm
MAXIMUM HEIGHT	21,5 cm	23,8 cm	25,7 cm	27,9 cm	29,8 cm	32 cm
CODE	25S800	25S900**	25S958	25S1058**	25S1114	25S1214**
CASE PACK	2	2	2	2	2	2
EXT. RACK HEIGHT	26,7 cm	26,7 cm	30,8 cm	30,8 cm	34,9 cm	34,9 cm

** Compartment Extenders cannot be added.

30 COMPARTMENT

7,94 cm
MAXIMUM DIAMETER

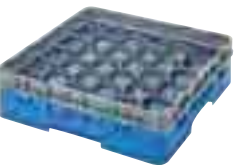

MAXIMUM HEIGHT	9,2 cm	13,3 cm	17,4 cm	21,5 cm	25,7 cm	29,8 cm
CODE	30S318	30S434	30S638	30S800	30S958	30S1114
CASE PACK	5	4	3	2	2	2
EXT. RACK HEIGHT	50 x 50 x 14,3 cm	50 x 50 x 18,4 cm	50 x 50 x 22,5 cm	50 x 50 x 26,7 cm	50 x 50 x 30,8 cm	50 x 50 x 34,9 cm

Full Size Camracks® for Stemware & Tumblers

7,3 cm
MAXIMUM DIAMETER



36 COMPARTMENT

MAXIMUM HEIGHT	9,2 cm	11,4 cm	13,3 cm	15,5 cm	17,4 cm	19,6 cm
CODE	36S318	36S418**	36S434	36S534**	36S638	36S738**
CASE PACK	5	5	4	4	3	3
EXT. RACK HEIGHT	14,3 cm	14,3 cm	18,4 cm	18,4 cm	22,5 cm	22,5 cm
MAXIMUM HEIGHT	21,5 cm	23,8 cm	25,7 cm	27,9 cm	29,8 cm	32 cm
CODE	36S800	36S900**	36S958	36S1058**	36S1114	36S1214**
CASE PACK	2	2	2	2	2	2
EXT. RACK HEIGHT	26,7 cm	26,7 cm	30,8 cm	30,8 cm	34,9 cm	34,9 cm

6,2 cm
MAXIMUM DIAMETER



49 COMPARTMENT

MAXIMUM HEIGHT	9,2 cm	13,3 cm	17,4 cm	21,5 cm	25,7 cm	29,8 cm
CODE	49S318	49S434	49S638	49S800	49S958	49S1114
CASE PACK	5	4	3	2	2	2
EXT. RACK HEIGHT	14,3 cm	18,4 cm	22,5 cm	26,7 cm	30,8 cm	34,9 cm



Base Rack Colors:

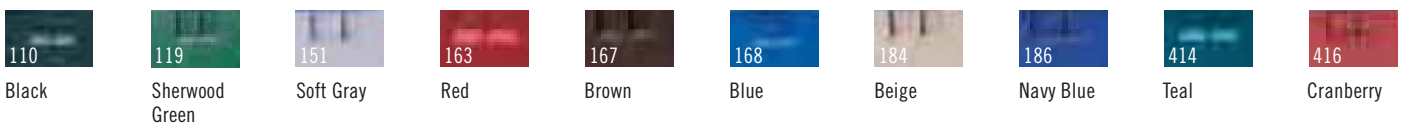

Extender Color: Soft Grey (151). ** Compartment Extenders cannot be added. Personalization available. See Camrack personalization and color coding page. For a more accurate color representation, call your sales rep for actual color chips. Contact Customer Service for all special orders.

Half Size Camracks® For Stemware & Tumblers

- Very effective for carrying less weight and for storing drinkware in space-restricted locations.
- Ideal for small under-counter glasswashers.

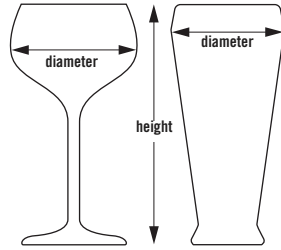

10HS434

Match a glass to a rack at www.cambro.com/Reference_Guides.

8 COMPARTMENT

10,3 cm
MAXIMUM DIAMETER



MAXIMUM HEIGHT	9,2 cm	13,3 cm	17,4 cm	21,5 cm	25,7 cm	29,8 cm
CODE	8HS318	8HS434	8HS638	8HS800	8HS958	8HS1114
CASE PACK	5	4	3	2	2	2
EXT. RACK HEIGHT	14,3 cm	18,4 cm	22,5 cm	26,7 cm	30,8 cm	34,9 cm

10 COMPARTMENT

8,7 cm
MAXIMUM DIAMETER



MAXIMUM HEIGHT	9,2 cm	13,3 cm	17,4 cm	21,5 cm	25,7 cm	29,8 cm
CODE	10HS318	10HS434	10HS638	10HS800	10HS958	10HS1114
CASE PACK	5	4	3	2	2	2
EXT. RACK HEIGHT	14,3 cm	18,4 cm	22,5 cm	26,7 cm	30,8 cm	34,9 cm

17 COMPARTMENT

7,3 cm
MAXIMUM DIAMETER



MAXIMUM HEIGHT	9,2 cm	13,3 cm	17,4 cm	21,5 cm	25,7 cm	29,8 cm
CODE	17HS318	17HS434	17HS638	17HS800	17HS958	17HS1114
CASE PACK	5	4	3	2	2	2
EXT. RACK HEIGHT	14,3 cm	18,4 cm	22,5 cm	26,7 cm	30,8 cm	34,9 cm

Base Rack Colors:

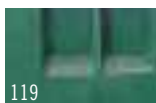

119
Sherwood Green



151
Soft Grey

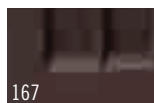

167
Brown

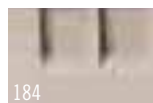

184
Beige



186
Navy Blue



416
Cranberry

Extender Color: Soft Grey (151). Personalization available. See Camrack personalization and color coding page. For a more accurate color representation, call your sales rep for actual color chips. Contact Customer Service for all special orders.

Camrack® Full & Half Size Cup Racks

- Tilt feature drains water from mug or cup bases for quick and sanitary drying.

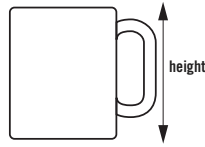

16C414

16 COMPARTMENT

11,1 x 10,95 cm

COMPARTMENT DIMENSIONS

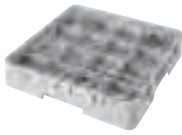

	MAXIMUM HEIGHT	6,6 cm	10,7 cm	14,9 cm
CODE		16C258	16C414	16C578
CASE PACK		6	5	4
EXT. RACK HEIGHT		10,1 cm	14,3 cm	18,4 cm

20 COMPARTMENT

11,1 x 8,73 cm

COMPARTMENT DIMENSIONS

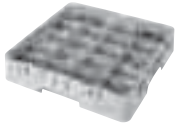

	MAXIMUM HEIGHT	6,6 cm	10,7 cm
CODE		20C258	20C414
CASE PACK		6	5
EXT. RACK HEIGHT		10,1 cm	14,3 cm



8 COMPARTMENT

10,4 x 11,1 cm

COMPARTMENT DIMENSIONS



	MAXIMUM HEIGHT	6,6 cm	10,7 cm
CODE		8HC258	8HC414
CASE PACK		6	5
EXT. RACK HEIGHT		10,1 cm	14,3 cm

10 COMPARTMENT

10,4 x 8,73 cm

COMPARTMENT DIMENSIONS



	MAXIMUM HEIGHT	6,6 cm	10,7 cm
CODE		10HC258	10HC414
CASE PACK		6	5
EXT. RACK HEIGHT		10,1 cm	14,3 cm

Glass and Cup Keepers

- Raised ribs for easy draining and drying.
- Holds 20 glasses or 12 cups per layer.

Color: Beige (133).



Max. Glass Inside Rim Diameter:
GK2000: 6,6 cm



Max. Cup Inside Rim Diameter:
KK1200: 7,4 cm

CODE	SIZE	CASE PACK
Glass Keepers		
GK2000 (Regal)	35,6 x 45,7 cm	12
Cup Keepers		
KK1200 (Regal)	35,4 x 45,4 cm	12

Base Cup Rack Color: Soft Grey (151). Extender Color: Soft Grey (151). Personalization available. See Camrack personalization and color coding page. Contact Customer Service for all special orders.

Store and Transport Glasses & Dishes

Camrack® Cover & Camdolly®

- Use to cover and protect full size Camrack dishracks filled with clean dishware.
- When used with a Camdolly, creates a portable sanitary storage system that protects contents between uses.
- Eliminates the use of messy, wasteful plastic wrap or vinyl covers.



FULL RACK COVER

CODE	DRC2020
EXTERIOR DIMENSIONS	50 x 50 x 2,4 cm

Case Pack: 1 Color: Grey (180).



CAMDOLLY WITH HANDLE

	CAMDOLLY	CAMDOLLY WITH HANDLE
CODE	CDR2020	CDR2020H
INTERIOR DIMENSIONS	53 x 53 cm	53 x 53 cm
EXTERIOR DIMENSIONS	54,5 x 54,5 x 20,5 cm	54,5 x 59,5 x 94 cm
LOAD CAPACITY	159 kg	159 kg

Case Pack: 1 Color: Soft Grey (151). Casters: 10 cm casters, 4 swivel, no brakes.

Camrack IceExpress Glass Filler

- Dramatically reduces banquet set-up time.
- Fills 25 glasses with ice all at once.
- Reduces breakage and risk of contamination.
- Ice falls directly into glasses with no spills or drips.

CODE	EXTERIOR DIMENSIONS W x D x H
25SWGf	50,8 cm x 50,8 cm x 3,18 cm

Case Pack: 1 Color: Black (110).



Selecting The Right Camrack

Selecting the Right Camrack

Cambro offers multiple ways to help you quickly find the right Camrack:

1. www.cambro.com/mycamracks

To quickly find the correct Camrack, please visit www.cambro.com/mycamracks. Select the item you are sizing, enter the measurements and quantity of the item, and the right Camrack will appear on the page.

2. Cambro Catalog

Flip to the back of this section for a convenient stemware and glass sizing reference guide.

3. Cambro Sales Representatives

Contact your local Cambro representative and he or she will walk through your current ware handling system with you and specify Camracks®, dollies and covers that will fit your glasses and dishware. To find your local representative refer to the back section of this catalog, visit www.cambro.com and click on "Find a Sales Rep" on the lower left of your screen or call the Cambro Customer Service line: 31-168-707-210.

4. Send a Sample to Cambro

C.E.L. Customer Service.
c/o DHL Solutions, Tradeboulevard 3,
4761 RL Moerdijk, Holland.

Please be sure to include complete contact information and specify if you need full-size or half-size Camracks.

Choose the correct Camrack:

1. Measure the maximum diameter of the glass (stemware or tumbler) to determine the number of compartments.
2. Measure the maximum height of the glass (stemware or tumbler) to the top edge of the rim to determine the compartment height.

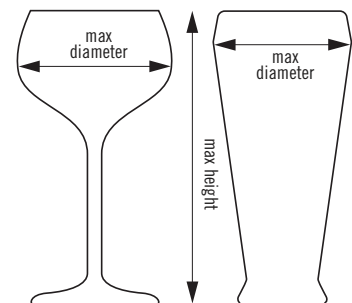

Camrack® Base Racks

- For pots, pans, bowls and large prep, service and display items.
- Half racks work well for storing items at a wait station.



BR578

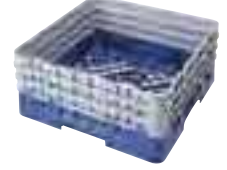
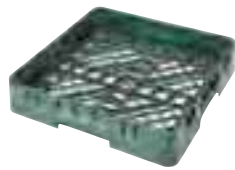

FULL SIZE BASE RACKS

	FULL BASE RACK	WITH 1 EXTENDER	WITH 2 EXTENDERS	WITH 3 EXTENDERS
CODE	BR258	BR414	BR578	BR712
INSIDE RACK HEIGHT	8,3 cm	12,4 cm	16,5 cm	20,6 cm
OUTSIDE RACK HEIGHT	10,1 cm	14,3 cm	18,4 cm	22,5 cm
CASE PACK	6	5	4	3

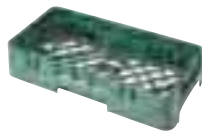

HALF SIZE BASE RACKS

	HALF BASE RACK	WITH 1 EXTENDER	WITH 2 EXTENDERS	WITH 3 EXTENDERS
CODE	HBR258	HBR414	HBR578	HBR712
INSIDE RACK HEIGHT	8,3 cm	12,4 cm	16,5 cm	20,6 cm
OUTSIDE RACK HEIGHT	10,1 cm	14,3 cm	18,4 cm	22,5 cm
CASE PACK	6	5	4	3

Hold Down Grid

Keeps lightweight smallwares in place during wash cycle. Use on full size Camrack base rack.



CRPHDG2878

FULL SIZE HOLD DOWN GRID

CODE	CRPHDG2878
Case Pack: 6	Color: Gray (000).

Base Rack Colors:

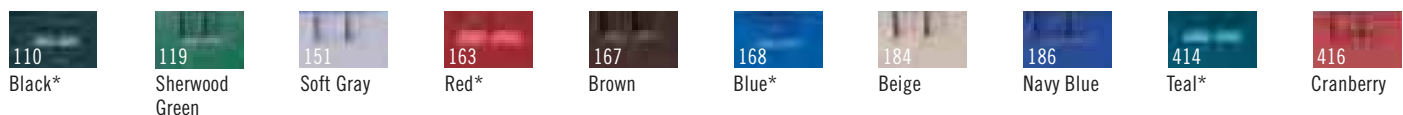

*Full size only. Extender Color: Soft Grey (151). Personalization available. See Camrack personalization and color coding page. For a more accurate color representation, call your sales rep for actual color chips. Contact Customer Service for all special orders.

Camrack® Full Size Peg Racks & Tray Rack

Standard 9 x 9 Peg Rack

- Designed to wash varying sized plates, bowls, trays and plate covers.
- Standard peg racks hold:
 - Eighteen 25,4 cm plates
 - Twelve 30,5 cm plates
 - Twenty-seven 19 cm plates
 - or
 - Nine 36 x 46 cm trays

5 x 9 Peg Rack

- Holds standard plates in one direction or deep plates, bowls and plate covers in the other direction.
- 5 spacing configuration holds up to ten 25,4 cm bowls, deep plates, platters or plate covers.

- 9 spacing configuration holds up to:

- Eighteen 25,4 cm plates
- Twelve 30,5 cm plates
- Twenty-seven 19 cm plates
- or
- Nine 36 x 46 cm trays

Open End Tray Rack

- Holds cafeteria trays or full-size sheet pans.
- Open-ended on one side for easy placement and removal of trays of all lengths.
- Holds up to nine trays upright.



	9 X 9 PEG RACK	9 X 9 PEG RACK WITH 1 EXTENDER	5 X 9 PEG RACK	5 X 9 PEG RACK WITH 1 EXTENDER	OPEN END TRAY RACK
CODE	PR314	PR500	PR59314	PR59500	OETR314*
INSIDE RACK HEIGHT	8,3 cm	12,4 cm	8,3 cm	12,4 cm	8,3 cm
OUTSIDE RACK HEIGHT	10,1 cm	14,3 cm	10,1 cm	14,3 cm	10,1 cm
CASE PACK	6	5	6	5	6

Color: Soft Gray (151). **Extender Color:** Soft Gray (151). **InStock Color:** Soft Gray (151). Personalization available. See Camrack personalization and color coding page. Contact Customer Service for all special orders. *Extenders may be added to all Peg Racks except the OETR314.

Camrack Full & Half Size Flatware Racks & Cylinder

- 8 Compartment Basket fits into a Full or Half Size Base Rack. Wire handles slide down for easy storage.
- Flatware Cylinder fits into 9-Compartment Full Size Camrack and the Cambro Tray and Dish storage Cart, model TDCR12.

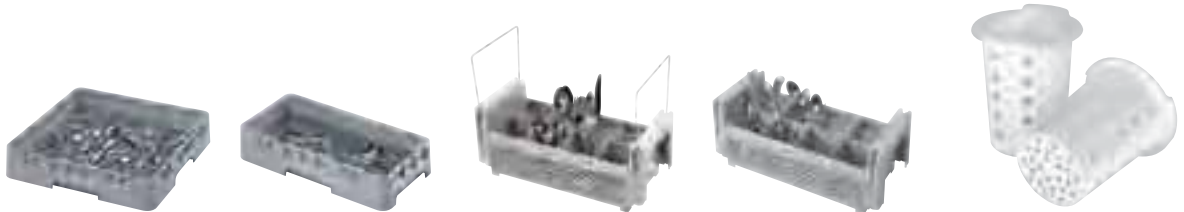

	FULL FLATWARE RACK	HALF FLATWARE RACK	8 COMPARTMENT HALF FLATWARE BASKET	8 COMPARTMENT HALF FLATWARE BASKET	FLATWARE CYLINDER
CODE	FR258	HFR258	8FB434* With Handles	8FBNH434* No Handles	FWC56
INSIDE RACK HEIGHT	6,7 cm	6,7 cm	12 cm	12 cm	Wide 11,4 cm
OUTSIDE RACK HEIGHT	10,1 cm	10,1 cm	18,4 cm	18,4 cm	High 14 cm
CASE PACK	6	6	6	6	12

Color: Soft Gray (151). **Extender Color:** Soft Gray (151). **InStock Color:** Soft Gray (151). **Flatware Cylinder Color:** White (148). Personalization available. See Camrack personalization and color coding page. Contact Customer Service for all special orders. * Extenders cannot be added.

PlateSafe® Camrack® – Store and Transport Dishes. All-In-One.

- Effectively store and transport dinnerware.
- Vinyl-coated steel grids safely hold and separate plates within each rack.
- Add a Camdolly® and Cover to create a completely enclosed, sanitary storage unit between uses.
- Reduces breakage.
- Holds plates upright and securely in place.
- No need to transfer to dish caddies, reducing labor.



Transport racks to banquet area for quick set up.



CRP2878



Portable Sanitary Storage System

PlateSafe Camracks stacked on a Camdolly and covered with a Camrack Cover offers the best and most effective sanitary storage and transport system for dishes.



CRPH1656

Half Size PlateSafe Camrack

PlateSafe Camracks

13 different styles of full size PlateSafe Camracks to transport plates from 10,1 to 31,7 cm in diameter.

PLATE SIZE	10,1 – 12,7 cm	10,1 – 15,2 cm	12,7 – 15,2 cm	15,2 – 17,7 cm	15,2 – 19,3 cm	17,7 – 21,9 cm	22,8 – 26 cm	22,8 – 26,6 cm
MAX. PLATE HEIGHT	1,9 cm	5 cm	1,9 cm	1,9 cm	2,5 cm	2,5 cm	2,5 cm	4,4 cm
# OF PLATES	63	20	48	44	30	28	20	12
CODE	CRP631013	CRP201015	CRP481315	CRP441518	CRP301519	CRP281822	CRP202326	CRP122327
RACK SIZE	FULL	FULL	FULL	FULL	FULL	FULL	FULL	FULL
EXT. RACK HEIGHT	18,4 cm	18,4 cm	18,4 cm	22,5 cm	22,5 cm	26,7 cm	30,8 cm	30,8 cm
CASE PACK	2	2	2	2	2	1	1	1

PLATE SIZE	22,8 – 28,2 cm	22,8 – 27,9 cm	25,4 – 27,9 cm	26,6 – 31,7 cm	29,2 – 31,7 cm	12,7 – 17,5 cm
MAX. PLATE HEIGHT	4,4 cm	5,7 cm	2,5 cm	3,4 cm	2,5 cm	2,5 cm
# OF PLATES	12	9	19	14	18	16
CODE	CRP122328	CRP92328	CRP192528	CRP142732	CRP182832	CRPH161317
RACK SIZE	FULL	FULL	FULL	FULL	FULL	HALF
EXT. RACK HEIGHT	30,8 cm	30,8 cm	30,8 cm	34,9 cm	34,9 cm	18,4 cm
CASE PACK	1	1	1	1	1	4

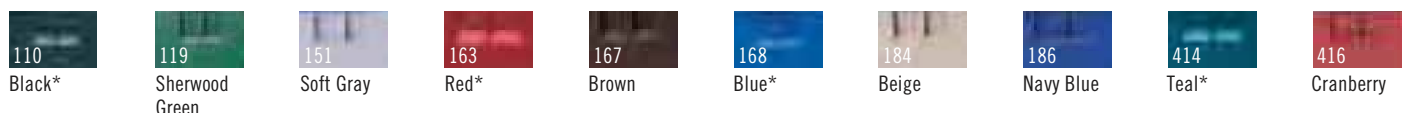

* Full size only. Extender Color: Soft Gray (151). Personalization available. See Camrack personalization and color coding page. For a more accurate color representation, call your sales rep for actual color chips. Contact Customer Service for all special orders.

The Camrack® Component System

The Camrack System offers several choices for ordering the right Camracks now and as your needs change. Please consult with your sales representative or Cambro Customer Service for all special ordering and assembly directions.

Choose Between:

1. A complete selection of pre-assembled, ready to use Camracks listed in our catalog; or
2. Custom built special order Camracks for specific needs; or
3. Individual Camrack components for distributors to stock and build racks as needed.

Base Rack Colors:

Sherwood Green (119), Soft Grey (151), Brown (167), Beige (184), Navy Blue (186), Cranberry (416), Black (110)*, Red (163)*, Blue (168)*, Teal (414)*.

Base Cup Rack Color: Soft Grey (151).

Extender Color: Soft Grey (151).

Personalization available.

Full Base Racks are covered by U.S. Patent D 412,607.

Half Base Racks are covered by U.S. Patent D 404,176.

* Full size only.

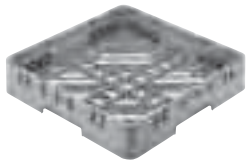

BR = Full Size Base Rack

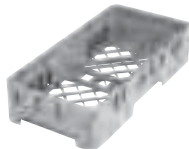

HBR = Half Size Base Rack

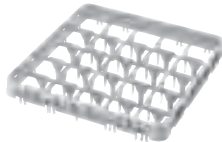

E1 = Full Size Full Drop Compartment Extender

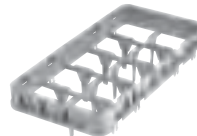

HE1 = Half Size Full Drop Compartment Extender



E2 = Full Size Half Drop Compartment Extender

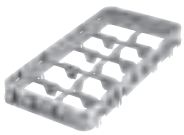

HE2 = Half Size Half Drop Compartment Extender

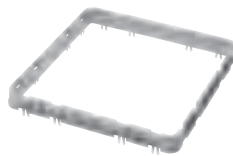

E3 = Full Size Open Extender

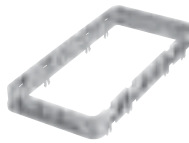

HE3 = Half Size Open Extender

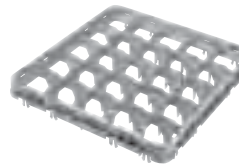

E4 = Full Size Full Drop Stemware Extender

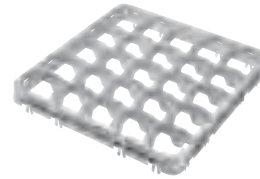

E5 = Full Size Half Drop Stemware Extender

Only E3 extenders may be added to E4's and E5's.

Camracks Components

CODE	DESCRIPTION	EXTERIOR DIMENSIONS	COMPARTMENT	INSIDE RACK HEIGHT	CASE PACK
Full Size Base Racks					
BR258*	Full Base Rack	500 x 500 x 101 mm	457 x 457 mm	67 mm	6
Half Size Base Racks					
HBR258	Half Base Rack	500 x 250 x 101 mm	464 x 213 mm	67 mm	6
Full Size Base Cup Racks					
16C258	16-Compartment Full Cup Rack	500 x 500 x 101 mm	111 x 111 mm	67 mm	6
20C258	20-Compartment Full Cup Rack	500 x 500 x 101 mm	111 x 89 mm	67 mm	6
Half Size Base Cup Racks					
8HC258	8-Compartment Half Cup Rack	500 x 250 x 101 mm	105 x 113 mm	67 mm	6
10HC258	10-Compartment Half Cup Rack	500 x 250 x 101 mm	105 x 89 mm	67 mm	6
Full Size Full Drop Extenders – E1 and GE1					
9E1	9-Compartment Full Drop Extender	499 x 499 x 51 mm	150 x 150 mm	41 mm	12
16E1	16-Compartment Full Drop Extender	499 x 499 x 51 mm	111 x 111 mm	41 mm	12
20GE1	20-Compartment Full Drop Extender	499 x 499 x 51 mm	98 x 98 mm	41 mm	12
25E1	25-Compartment Full Drop Extender	499 x 499 x 51 mm	89 x 89 mm	41 mm	12
30GE1	30-Compartment Full Drop Extender	499 x 499 x 51 mm	79 x 79 mm	41 mm	12
36E1	36-Compartment Full Drop Extender	499 x 499 x 51 mm	73 x 73 mm	41 mm	12
49E1	49-Compartment Full Drop Extender	499 x 499 x 51 mm	62 x 62 mm	41 mm	12

The Camrack® Component System

CODE	DESCRIPTION	EXTERIOR DIMENSIONS	COMPARTMENT	INSIDE RACK HEIGHT	CASE PACK
Full Size Half Drop Extenders – E2					
9E2	9-Compartment Half Drop Extender	499 x 499 x 51 mm	150 x 150 mm	41 mm	12
16E2	16-Compartment Half Drop Extender	499 x 499 x 51 mm	111 x 111 mm	41 mm	12
20E2	20-Compartment Half Drop Extender (for cups only)	499 x 499 x 51 mm	111 x 89 mm	41 mm	12
20GE2	20-Compartment Half Drop Extender	499 x 499 x 51 mm	98 x 98 mm	41 mm	12
25E2	25-Compartment Half Drop Extender	499 x 499 x 51 mm	89 x 89 mm	41 mm	12
30GE2	30-Compartment Half Drop Extender	499 x 499 x 51 mm	79 x 79 mm	41 mm	12
36E2	36-Compartment Half Drop Extender	499 x 499 x 51 mm	73 x 73 mm	41 mm	12
49E2	49-Compartment Half Drop Extender	499 x 499 x 51 mm	62 x 62 mm	41 mm	12
Full Size Open Extender – E3					
E3	Open Extender	499 x 499 x 51 mm	457 x 457 mm	41 mm	12
Full Size Full Drop Extenders – E4					
16E4	16-Compartment Full Drop Extender	499 x 499 x 51 mm	111 x 111 mm	41 mm	12
25E4	25-Compartment Full Drop Extender	499 x 499 x 51 mm	89 x 89 mm	41 mm	12
36E4	36-Compartment Full Drop Extender	499 x 499 x 51 mm	73 x 73 mm	41 mm	12
Full Size Half Drop Extenders – E5					
16E5	16-Compartment Half Drop Extender	499 x 499 x 51 mm	111 x 111 mm	41 mm	12
25E5	25-Compartment Half Drop Extender	499 x 499 x 51 mm	89 x 89 mm	41 mm	12
36E5	36-Compartment Half Drop Extender	499 x 499 x 51 mm	73 x 73 mm	41 mm	12
Half Size Full Drop Extenders – HE1					
8HE1	8-Compartment Full Drop Extender	502 x 252 x 51 mm	105 x 113 mm	41 mm	12
10HE1	10-Compartment Full Drop Extender	502 x 252 x 51 mm	105 x 89 mm	41 mm	12
17HE1	17-Compartment Full Drop Extender	502 x 252 x 51 mm	74 mm diameter	41 mm	12
Half Size Half Drop Extenders – HE2					
8HE2	8-Compartment Half Drop Extender	502 x 252 x 51 mm	105 x 113 mm	41 mm	12
10HE2	10-Compartment Half Drop Extender	502 x 252 x 51 mm	105 x 89 mm	41 mm	12
17HE2	17-Compartment Half Drop Extender	502 x 252 x 51 mm	74 mm diameter	41 mm	12
Half Size Open Extender – HE3					
HE3	Open Extender	502 x 252 x 51 mm	464 x 213 mm	41 mm	12

Base Rack Colors: Sherwood Green (119), Soft Gray (151), Brown (167), Beige (184), Navy Blue (186), Cranberry (416), Black (110)*, Red (163)*, Blue (168)*, Teal (414)*.

Base Cup Rack Color: Soft Gray (151). **Extender Color:** Soft Gray (151). * Color available in full size only. All extenders are available in Soft Gray (151). All pre-assembled racks ship with Soft Gray (151) extenders. **PlateSafe Grid Color:** Gray (000).



The Camrack® Component System

PLATESAFE® GRIDS USED TO BUILD PLATESAFE RACKS

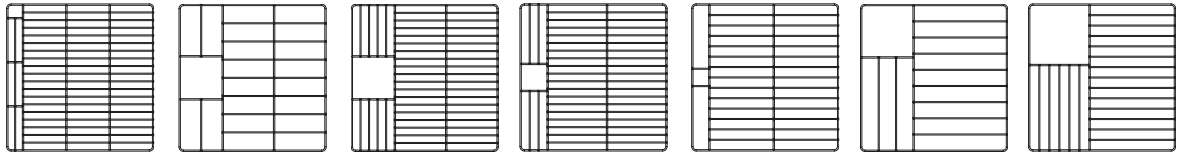

PLATESAFE GRID CODE	CRPG6345	CRPG2046	CRPG4856	CRPG4467	CRPG3067	CRPG12911	CRPG20910
PLATESAFE RACK CODES	CRP631013	CRP201015	CRP481315	CRP441518	CRP301519	CRP122328	CRP202326
PLATE SIZE	10,2-12,7 cm	10,2-15,2 cm	12,7-15,2 cm	15,2-17,8 cm	15,2-19,4 cm	22,9-28,3 cm	22,9-26 cm
MAX. PLATE HEIGHT	1,91 cm	5,8 cm	1,91 cm	1,91 cm	2,54 cm	4,45 cm	2,54 cm
# OF PLATES PER RACK	63	20	48	44	30	12	20

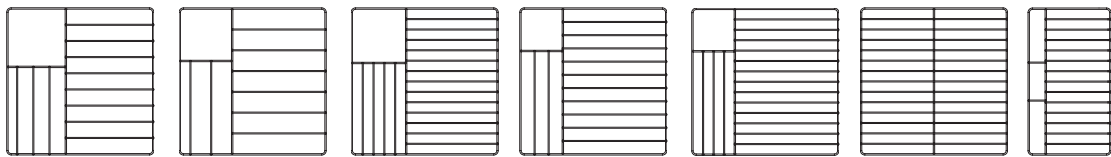

PLATESAFE GRID CODE	CRPG12910	CRPG9911	CRPG191011	CRPG141012	CRPG181112	CRPG2878	HALF SIZE GRID CRPHG1656
PLATESAFE RACK CODES	CRP122327	CRP92328	CRP192528	CRP142732	CRP182832	CRP281822	CRPH161317
PLATE SIZE	22,9-26,7 cm	22,9-27,9 cm	25,4-27,9 cm	26,7-31,8 cm	27,9-31,8 cm	17,8-21,9 cm	12,7-17,5 cm
MAX. PLATE HEIGHT	4,45 cm	5,72 cm	2,54 cm	3,51 cm	2,54 cm	2,54 cm	2,54 cm
# OF PLATES PER RACK	12	9	19	14	18	28	16

Case Pack: 12

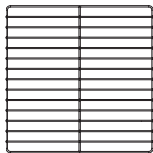

HOLD DOWN GRID
CRPHDG2878
CASE PACK: 6



Let's Get Personal – Personalized Camracks®

Personalize Camracks to identify contents at a glance for accurate inventory control and selection.

Hot stamp a custom logo, information or standard content symbols, and/or descriptions on two opposite, diagonal sides of any rack.

Or request the addition of pre-printed clips. Up to 4 Camrack or PlateSafe clips can be added only at time of assembly and require the addition of at least one extender.



IMPRINT COLOR-WHITE

HOW TO ORDER A SAMPLE

1. Contact your local Cambro rep to complete and submit a sample request form to Cambro.
2. Select rack size, code and color. Imprint color - white only.
3. Choose process A) Hot Stamp or B) Camrack Clips
4. Indicate location of hot stamp and/or clip on rack. Maximum hot stamp imprint size is 102 mm W x 31,7 mm H. Maximum hot stamp imprinting thickness per solid letter or logo should be no more than 102 mm wide.
5. If selecting process A with a custom hot stamp, provide ready to use artwork, digital format only. Sample request form must be submitted to Cambro PRIOR to artwork being sent. If artwork is incomplete, graphic support services are available for ** per hour.

6. Submit Artwork

E-mail artwork to your Cambro Rep or direct to Cambro at letsgetpersonal@cambro.com. Title e-mail subject with logo name and provide contact info.

File dimensions: 100% reproduction size, 300dpi resolution.

File type:

Adobe® Illustrator®, Photoshop®.

File format: jpeg, tiff, and eps.

Or mail digital artwork to: Cambro Manufacturing Company. Attn: Kristie Patterson, 7601 Clay Avenue, Huntington Beach, CA 92648.

7. Questions regarding artwork?

Tel: (49)7022-90-100-0; Ireland Tel: 1800 509 046; for UK Tel: 0800 587 0057 or Fax: (49)7022-90-100-19.

8. Sample Approval

A signed sample approval form must be faxed to Cambro customer service prior to processing any purchase orders. This form is included with each sample.

PERSONALIZATION CHARGES

One Time Plate Charge	** for custom hot stamp only
Set-Up Charge	**
Sample Charge	**
Imprint Charge	** per side, 2 sides max.

FOR CLIPS

Drinkware or PlateSafe®, pre-printed ** each

** Contact your Cambro representative for pricing.



PERSONALIZATION OPTIONS

HOT STAMPING



CUSTOM LOGO AND/OR TEXT



STANDARD SYMBOL AND DESCRIPTION



STANDARD SYMBOL ONLY



STANDARD DESCRIPTION ONLY

CAMRACK CLIPS



WITH SYMBOL AND DESCRIPTION

Standard Hot Stamp Symbols and/or Descriptions

Step 1. Choose a symbol and corresponding letter.

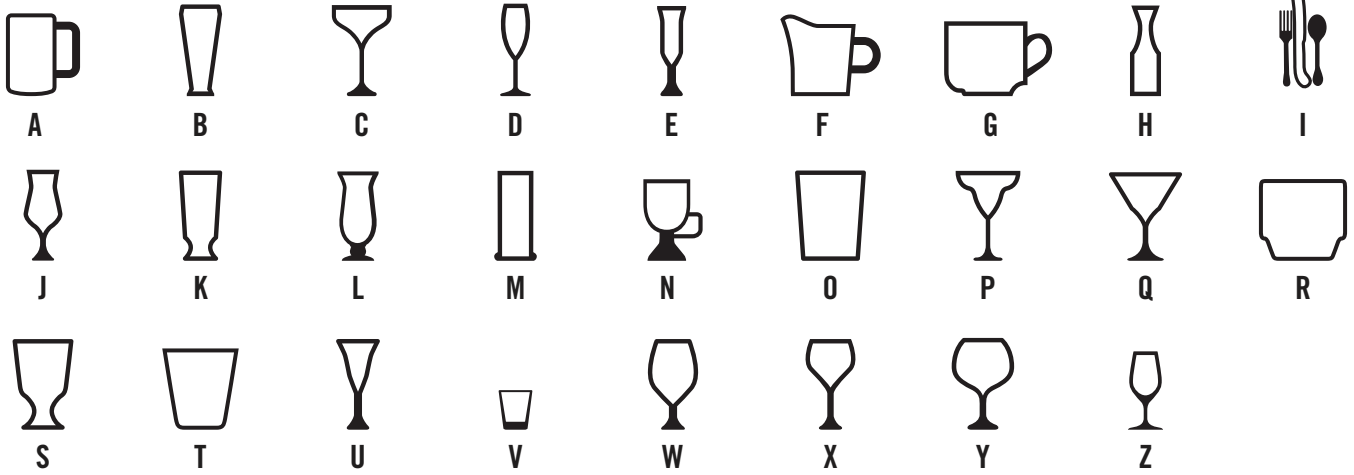

Standard PlateSafe® Clips

DINNER



APPETIZER



PASTA



BREAD



SALAD



SOUP



SAUCER



DESSERT



Step 2. Choose the verbiage and corresponding number that best describes your glassware. **Available in English Only.**

- | | | |
|--------------------|---------------------------|---------------------------|
| 1. Beer | 15. Grande | 27. Shot Glass |
| 2. Beer Mug | 16. Hi-Ball | 28. Sorbet |
| 3. Pilsner | 17. Hurricane | 29. Water (Footed Style) |
| 4. Brandy | 18. Iced Tea | 30. Water (Tumbler Style) |
| 5. Champagne | 19. Irish Coffee | 31. White Wine |
| 6. Champagne Flute | 20. Juice | 32. Wine |
| 7. Coffee Mug | 21. Margarita | 33. Red Wine |
| 8. Collins | 22. Martini | 34. Port |
| 9. Cordial | 23. Old Fashion | |
| 10. Creamer | 24. Rocks (Footed Style) | |
| 11. Cup | 25. Rocks (Tumbler Style) | |
| 12. Decanter | 26. Sherry | |
| 13. Flatware | | |
| 14. Goblet | | |

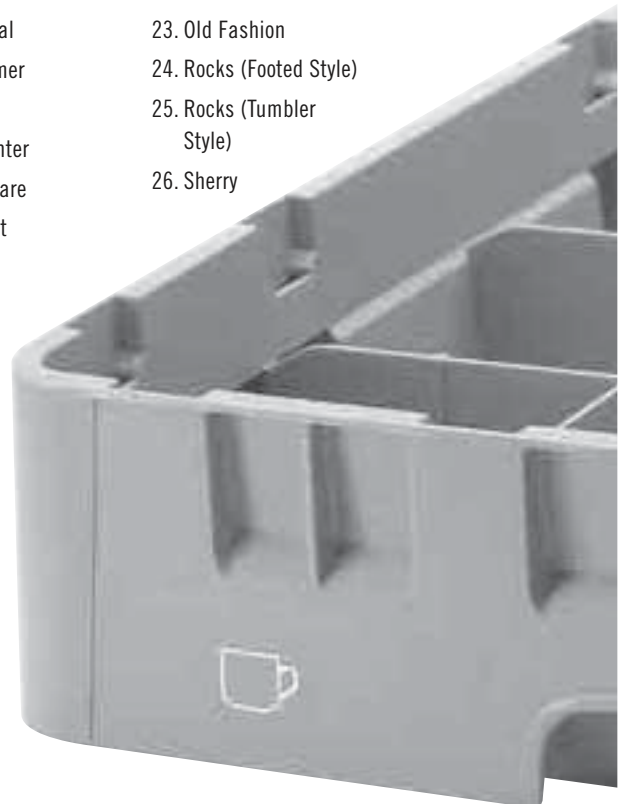

(Available in English Only)

Camdollies®

- Use to transport anything from stacks of sheet pans to catering equipment.
- Reduce employee lifting and carrying, reducing possible injury.
- Made of extremely durable plastic that will not dent, crack, rust or corrode.
- Heavy-duty casters maneuver easily over all types of terrain.
- For heavy transport needs, select models with handles and rear Big Wheels.

Colors: Coffee Beige (157), Dark Brown (131), Black (110), Slate Blue (401), Gray (180).
CDR2020, CDR2020H Color: Soft Gray (151).

Caster Type

- A:** 12,7 cm Casters: 2 fixed, 2 swivel, 1 with brake.
B: 7,6 cm Casters: 4 swivel, no brakes.
C: 25,4 cm Rear Big Wheels, 2 front 12,7 cm swivel casters, 1 with brake.
D: 8,9 cm Casters: 4 swivel, no brakes.

Available Parcel Carrier Delivery:

CDR2020, CDR2020H, CD2020, CD1420, CD2028, CD1313, CD1327, CD100, CD160, CD200, CD300, CD400, CD1826PDB, 2030UT & 400STP.

Camdollies Case Pack: 1

*CDR2020H Not NSF Listed.

For Dish Racks

EXTERNAL DIM. W x D x H 54,5 x 53 x 18,7 cm
INTERIOR DIM. W x D 53 x 53 cm



CDR2020

159 kg CAPACITY	D CASTER TYPE
---------------------------	-------------------------



EXTERNAL DIM. W x D x H 53 x 64,1 x 92,7 cm
INTERIOR DIM. W x D 53 x 53 cm



CDR2020H*
(with powder coated handle)

159 kg CAPACITY	D CASTER TYPE
---------------------------	-------------------------



For 46 x 66 cm Trays and Sheet Pans

EXTERNAL DIM. W x D x H 50,8 x 80 x 97,2 cm
INTERIOR DIM. W x D 46 x 66 cm



CD1826H

Holds: UPC101

136 kg CAPACITY	A CASTER TYPE
---------------------------	-------------------------



EXTERNAL DIM. W x D x H 57 x 57 x 21 cm
INTERIOR DIM. W x D 51,1 x 51,1 cm



CD2020

Also Holds: 500LCD, 350LCD, 250LCD, 1000LCD, UC1000

159 kg CAPACITY	B CASTER TYPE
---------------------------	-------------------------



EXTERNAL DIM. W x D x H 59,7 x 82,6 x 93 cm
INTERIOR DIM. W x D 47 x 66 cm



CD1826HB

Holds: UPC101

136 kg CAPACITY	C CASTER TYPE
---------------------------	-------------------------



EXTERNAL DIM. W x D x H 56,5 x 65,7 x 93,7 cm
INTERIOR DIM. W x D 51,5 x 51,5 cm



CD2020H

Also Holds: 250LCD, 350LCD, 500LCD, 1000LCD

159 kg CAPACITY	B CASTER TYPE
---------------------------	-------------------------



For Pizza Dough Boxes

Also See Pizza Dough Boxes page 146

EXTERNAL DIM. W x D x H 50,5 x 71 x 26 cm
INTERIOR DIM. W x D 44,5 x 64,5 cm



CD1826PDB
(Optional Strap Available)

Holds: DB18263CW, DB18266CW, DB18263P

136 kg CAPACITY	A CASTER TYPE
---------------------------	-------------------------



EXTERNAL DIM. W x D x H 66,7 x 67,3 x 93 cm
INTERIOR DIM. W x D 52 x 52,5 cm



CD2020HB

Also Holds: 250LCD, 350LCD, 500LCD

159 kg CAPACITY	C CASTER TYPE
---------------------------	-------------------------



Camdollies® For Camcarriers® and Camtainers®

EXTERNAL DIM. W x D x H	50 x 73 x 27 cm
INTERIOR DIM. W x D	44 x 66,5 cm

Holds: 100MPC, UPC100, UC250, UC500, 250LCD, 350LCD, 500LCD



CD100

136 kg CAPACITY	A CASTER TYPE
---------------------------	-------------------------



EXTERNAL DIM. W x D x H	50 x 84 x 92 cm
INTERIOR DIM. W x D	45 x 67,5 cm

Holds: 100MPC, UC250, UC500, 250LCD, 350LCD, 500LCD



CD100H

159 kg CAPACITY	A CASTER TYPE
---------------------------	-------------------------

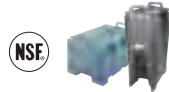

EXTERNAL DIM. W x D x H	60 x 83,5 x 93 cm
INTERIOR DIM. W x D	44,5 x 68 cm

Holds: 100MPC, UPC100, UC250, UC500, 250LCD, 350LCD, 500LCD



CD100HB

159 kg CAPACITY	C CASTER TYPE
---------------------------	-------------------------

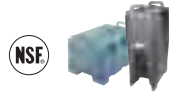

EXTERNAL DIM. W x D x H	42 x 62 x 26,5 cm
INTERIOR DIM. W x D	36 x 56 cm

Holds: UPC140, UPC160, UPC180, UPCS140, UPCS160, UPCS180, UPCS180, UPCS180



CD160

136 kg CAPACITY	A CASTER TYPE
---------------------------	-------------------------



EXTERNAL DIM. W x D x H	49 x 65 x 26,5 cm
INTERIOR DIM. W x D	43 x 59 cm

Holds: 300MPC, 1318MTC, UC1000, 1000LCD



CD300

136 kg CAPACITY	A CASTER TYPE
---------------------------	-------------------------



EXTERNAL DIM. W x D x H	61 x 89,5 x 93 cm
INTERIOR DIM. W x D	56 x 72,5 cm

Holds: 1826MTC



CD1826MTC

159 kg CAPACITY	A CASTER TYPE
---------------------------	-------------------------



EXTERNAL DIM. W x D x H	70 x 88,5 x 93,5 cm
INTERIOR DIM. W x D	55,5 x 72,5 cm

Holds: 1826MTC



CD1826MTC HB

159 kg CAPACITY	C CASTER TYPE
---------------------------	-------------------------



EXTERNAL DIM. W x D x H	48,5 x 76,5 x 92 cm
INTERIOR DIM. W x D	43 x 59 cm

Holds: 300MPC, 1318MTC, UC1000, 1000LCD



CD300H

159 kg CAPACITY	A CASTER TYPE
---------------------------	-------------------------



EXTERNAL DIM. W x D x H	60 x 76 x 92 cm
INTERIOR DIM. W x D	44 x 60 cm

Holds: 300MPC, 1318MTC, UC1000, 1000LCD



CD300HB

159 kg CAPACITY	C CASTER TYPE
---------------------------	-------------------------



EXTERNAL DIM. W x D x H	53 x 70 x 23 cm
INTERIOR DIM. W x D	46 x 63,5 cm

Holds: UPC400, UPCS400, UPCH400



CD400
(Shown with Optional Strap)

136 kg CAPACITY	A CASTER TYPE
---------------------------	-------------------------



Camdollies® for Milk Crates and #10 Can Cases

EXTERNAL DIM. W x D x H 41,28 x 55,25 x 21,11 cm
 INTERIOR DIM. W x D 35,24 x 49,05 cm



CD1420

Holds: 35,6 x 48,3 cm Milk Crates and #10 Can Cases

159 kg CAPACITY	B CASTER TYPE
--------------------	------------------



EXTERNAL DIM. W x D x H 56,6 x 77 x 21 cm
 INTERIOR DIM. W x D 49,5 x 71 cm



CD2028

Holds: 35,6 x 48,3 cm Milk Crates, #10 Can Cases and UPC101, 300MPC, UPC400, 100MPC, UPC100

159 kg CAPACITY	B CASTER TYPE
--------------------	------------------



EXTERNAL DIM. W x D x H 41 x 41 x 21 cm
 INTERIOR DIM. W x D 35 x 35 cm



CD1313

Holds: 30 x 30 cm Milk Crates

114 kg CAPACITY	B CASTER TYPE
--------------------	------------------



EXTERNAL DIM. W x D x H 40,6 x 73,7 x 21 cm
 INTERIOR DIM. W x D 34,6 x 67,6 cm



CD1327

Holds: 30 x 30 cm Milk Crates and #10 Can Cases

136 kg CAPACITY	B CASTER TYPE
--------------------	------------------



Utility Trucks

- Use for transporting loads of up to 272 kg.
- Large platforms for convenient loading and built-in handles for easy maneuvering.
- All models feature 12,7 cm heavy-duty casters bolted into molded-in metal backing plates.

Colors: Coffee Beige (157), Dark Brown (131), Black (110), Slate Blue (401), Gray (180), Brick Red (402), Kentucky Green (519).

Casters: 12,7 cm, 2 fixed, 2 swivel, 1 with brake.

Utility Trucks Case Pack: 1



2030UT
(With chrome handle)
45155
508 cm Long Strap

EXTERNAL DIM. W x D x H 50 x 81,5 x 98 cm
 LOAD PLATFORM 50 x 75 cm

272 kg
CAPACITY



EXTERNAL DIM. W x D x H 63,2 x 106 x 93,3 cm
 LOAD PLATFORM 60 x 90,5 cm



2436UTH
45155
508 cm Long Strap

272 kg
CAPACITY



EXTERNAL DIM. W x D x H 63,2 x 106 x 93,3 cm
 LOAD PLATFORM 60 x 90,5 cm



2436UTHS
(Includes two straps)

272 kg
CAPACITY



Camdolly® Strap for CD400 and CD1826PDB Camdollies

CODE	DESCRIPTION
400STP	Strap

Case Pack: 1



Tray & Dish Cart / Tray & Silverware Cart

Tray & Dish Cart

- Open storage compartment holds a wide variety of plates and trays.
- Use with or without detachable cutlery station.
- Made of easy-to-clean polyethylene that won't rust, peel or corrode.
- Rounded, molded-in corners protect furniture and walls.
- Molded-in handles and heavy-duty 15,2 cm swivel casters ease maneuvering.

Colors: Slate Blue (401), Coffee Beige (157), Dark Brown (131), Grey (180), Granite Grey (191), Granite Green (192).

15,2 cm Casters: All swivel, 2 with brake.

Vinyl cover is not NSF listed.



Flatware cylinders and vinyl cover included with TDCR12.

TDCR12

Use the vinyl cover for sanitary storage (included).

CODE	DESCRIPTION	EXTERIOR DIMENSIONS L x W x H
TDCR12	Cart & Rack Combination	97 x 58 x 105 cm
TDC2029*	Cart only	97 x 56,5 x 87 cm
CR12	Cutlery Rack only	84 x 58 x 23 cm
FWC56	Flatware Cylinder	11,4 W x 14 H cm

Case Pack: 1 **FWC56 Case Pack:** 12
*TDC2029 is not available in Black (110).

Tray & Silverware Cart

- Use to neatly organize trays and accessories for self-service.
- Includes eight clear Camwear® food pans to hold flatware, napkins and non-perishable condiments.
- Protective vinyl cover included.

Colors: Slate Blue (401), Coffee Beige (157), Dark Brown (131), Grey (180), Granite Grey (191), Granite Green (192).

15,2 cm Casters: All swivel, 2 with brake.

Vinyl cover is not NSF listed.



TC1418

Use the vinyl cover for sanitary storage (included).

CODE	DESCRIPTION	CASE PACK
TC1418	Cart w/Pans & Vinyl Cover	1

CODE	EXTERIOR DIMENSIONS L x W x H	WEIGHT CAPACITY	MAXIMUM TRAY SIZE	TRAY CAPACITY
TC1418	82 x 54 x 116 cm	227 kg	36 x 46 cm	180-200 in two stacks

Camwear Polycarbonate Pans for self-serve top:

PAN QUANTITY, SIZE	CAPACITY
4 each, 1/2 size x 10 cm deep	Holds 100 knives, 100 spoons, 80 forks
4 each, 1/2 size x 10 cm deep	Holds variety of condiments



S-Series Adjustable Dish Caddy



- Store one size dish or a combination of different sizes in a single caddy.
- Features easy-to-adjust column towers.

ADCS Colors: Black (110), Slate Blue (401), Speckled Grey (480), Dark Brown (131).

Casters: Two 12,7 cm, swivel with brakes and two 25,4 cm easy wheels.

Vinyl cover included. Not NSF listed.

For square and rectangular plates, please contact Cambro for suggested use.



Holds plates and bowls from 11,7 to 33 cm

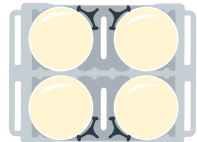

Plate sizes: ϕ 23,5 cm to 33 cm
4 Columns (60 each)
Total Capacity: 240

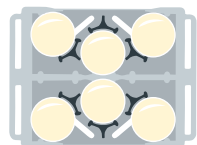

Plate sizes: ϕ 18,42 cm to 23,5 cm
6 Columns (60 each)
Total Capacity: 360

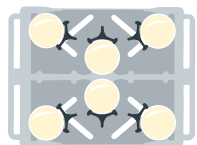
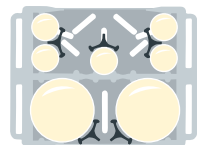
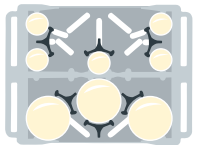

Plate sizes: ϕ 14,6 cm to 18,42 cm
6 Columns (45 each)
Total Capacity: 270



2 Columns: ϕ 23,5 cm to 33 cm (60 each)
5 Columns: ϕ 12,6 cm (45 each)
Total Capacity: 345



3 Columns: ϕ 18,42 cm to 23,5 cm (60 each)
5 Columns: ϕ 11,75 cm (45 each)
Total Capacity: 405

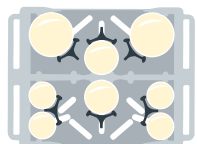

2 Columns: ϕ 18,42 cm to 23,5 cm (60 each)
2 Columns: ϕ 14,6 cm to 18,42 cm (45 each)
4 Columns: ϕ 12,6 cm (45 each)
Total Capacity: 390

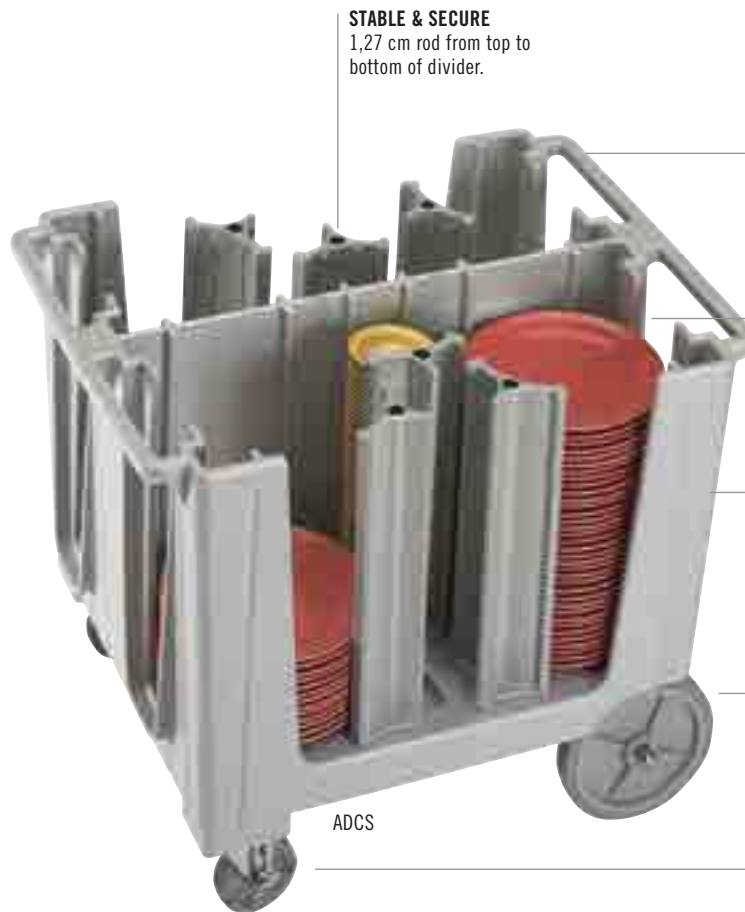

STABLE & SECURE
1,27 cm rod from top to bottom of divider.

EASY TO MANEUVER
Ergonomic molded-in handles on both ends.

HOLDING CAPACITY
49,5 cm storage columns hold 45-60 plates per stack.

EXTREMELY DURABLE
Heavy duty polyethylene construction protects china from chipping. Won't chip, crack or rust.

REAR WHEELS
25,4 cm non-marking Easy Wheels.

FRONT CASTERS
12,7 cm swivel with brake.



A 2 cm plated steel rear axle allows for 227 kg load capacity.



Vinyl cover included with every dolly for sanitary storage.

CODE	ADCS
NUMBER OF DIVIDERS	6
PLATES PER COLUMN	Approximately 45-60
OVERALL DIMENSIONS W x L x H	73 x 96 x 81 cm

Case Pack: 1 Plate size range from 11,7 to 33 cm.

Versa Dish Caddies™, Dish Caddies, Adjustable Tray & Dish Cart



Versa Dish Caddies

- Secure, high-capacity storage to protect both square and round plates.
- Durable, polyethylene exterior will not rust, crack, dent or chip.
- Poker chip style offers greater access for easy plate removal.
- A 2 cm plated steel rear axle allows for 227 kg load capacity.
- Molded-in handles on both ends for easy transporting.
- 12,7 cm front swivel casters with brake and 25,4 cm non-marking rear wheels ease maneuvering.
- No assembly required.

Colors: Black (110), Slate Blue (401), Dark Brown (131), Speckled Grey (480).

Casters: 2, 12,7 cm swivel with brakes and two 25,4 cm Easy Wheels.

Vinyl cover included. Not NSF listed.

DCS950 is covered by U.S. Patent D 603,120S. DCS1125 is covered by U.S. Patent D 625,894.



DCS950 holds 5 columns of 45-60 round plates up to 24,1 cm or 4 to 5 columns of square plates up to 20,5 cm.

DCS1125 holds 4 columns of 45-60 round plates up to 28,6 cm or square plates up to 24,1 cm.

Poker Chip Style Dish Caddies

- Use to store and protect valuable dishware.
- Dividers are molded into the body in a standard poker chip design.
- Made of durable polyethylene that protects plates from chipping.
- Open access from two sides for easy loading and unloading.
- Rounded corners inside and out protect dishware, furniture and walls.

Colors: Black (110), Slate Blue (401), Dark Brown (131), Granite Grey (191).

Casters: 2, 12,7 cm swivel with brakes and two 25,4 cm Easy Wheels.

Vinyl cover included. Not NSF listed.



DC700



Sanitary plastic cover included and recommended for protecting clean dinnerware & trays. Replacement covers are available through the Cambro Replacement Parts List at www.cambro.com.

Adjustable Tray & Dish Cart

- Use to store a wide variety of plates and trays.
- Move two adjustable dividers into position easily to secure trays and plates.
- Made of durable polyethylene that cushions plates and trays to prevent chipping.
- Easy to clean and won't dent, rust, chip or break.

Colors: Black (110), Slate Blue (401), Coffee Beige (157), Dark Brown (131), Grey (180), Granite Grey (191), Granite Green (192).

Casters: 15,2 cm all swivel, 2 with brake.

Maximum load capacity: 227 kg.

Vinyl cover included. Not NSF listed.



TDC30



Vinyl cover included with every dolly for sanitary storage.

Versa Dish Caddies™

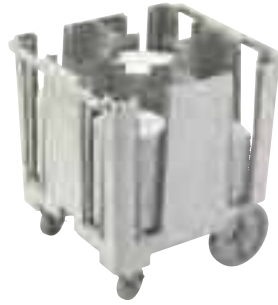

CODE	DCS950	DCS1125
PLATE SIZE RANGE (ROUNDS)	21,3 - 24,1 cm	24,4 - 28,6 cm
PLATE SIZE RANGE (SQUARES)	18,4 - 20,5 cm	21,3 - 24,1 cm
COLUMNS PER CADDY	5, 45-60 plates per col.	4, 45-60 plates per col.
OVERALL DIMENSIONS W x L x H	69 x 78 x 81 cm	69 x 78 x 81 cm

Case Pack: 1

Vinyl cover included with every dolly for sanitary storage.

Poker Chip Style Dish Caddies



CODE	DC575	DC700	DC825
PLATE SIZE RANGE	14,6 cm	14,9 - 17,8 cm	18,1 - 21 cm
COLUMNS PER CADDY	6, 45-60 plates per col.	6, 45-60 plates per col.	4, 45-60 plates per col.
OVERALL DIMENSIONS W x L x H	83 x 60 x 81 cm	83 x 60 x 81 cm	73 x 60,5 x 81,5 cm

Case Pack: 1

Poker Chip Style Dish Caddies



CODE	DC1225
PLATE SIZE RANGE	28,9 - 31,1 cm
COLUMNS PER CADDY	4, 45-60 plates per col.
OVERALL DIMENSIONS W x L x H	83 x 70 x 81,5 cm

Case Pack: 1

Adjustable Tray & Dish Cart



CODE	TDC30
NUMBER OF DIVIDERS	2
PLATES PER COLUMN	Approximately 45-60
TRAYS PER COLUMN	80 Trays: 36 x 46 cm
OVERALL DIMENSIONS W x L x H	59 x 99 x 88 cm

Case Pack: 1

Cambox® Bussing Boxes



Regal



CODE	1120CBR	1520CBR
DESCRIPTION	Four Compartment Cutlery Box	Cambox
DIM. L x W x H	28,9 x 52 x 9,5 cm	38,9 x 50,6 x 12,5 cm

Case Pack: 12 Colors: Black (110), Dark Brown (131).



CODE	1621CBR	21155CBR	21157CBR	1722CBR
DESCRIPTION	Cambox	Cambox	Cambox	Cambox
DIM. W x L x H	39,7 x 52 x 12,4 cm	38,7 x 51,4 x 12,5 cm (incl. handle)	38,6 x 51,2 x 17,6 cm	42,9 x 55,6 x 12,1 cm

Case Pack: 12 Colors: Black (110), Dark Brown (131).

Polyethylene



CODE	415CBP	912CBP	1120CBP	1520CBP & 1520CBPF*
DESCRIPTION	Cutlery Box	Utility Box	Four Compartment Cutlery Box	Cambox
DIM. W x L x H	11,3 x 36 x 10,3 cm	23 x 30,6 x 13 cm	28,9 x 52 x 9,5 cm	38,9 x 50,6 x 12,5 cm

Case Pack: 12 Colors: Black (110), Dark Brown (131), Light Grey (180). * 1520CBPF is identical to our current 1520CBP except the internal surface is flat.



CODE	1621CBP	21155CBP	21157CBP	1722CBP
DESCRIPTION	Cambox	Cambox	Cambox	Cambox
DIM. L x W x H	39,7 x 52 x 12,4 cm	38,7 x 51,4 x 12,5 cm (incl. handle)	38,6 x 51,2 x 17,6 cm	42,9 x 55,6 x 12,1 cm

Case Pack: 12 Colors: Black (110), Dark Brown (131), Light Grey (180).

Box Covers



CODE	1520CBCP	1722CBCP	2115CBCP	2115CBCR
FITS	1520CBP	1722CBR, 1722CBP	21155CBP, 21157CBP	2115CBR, 21157CBR
DIM. W x L	40,6 x 52 cm	44 x 56,8 cm	39,4 x 52 cm	39,4 x 52 cm

Case Pack: 12 Color: White (148).



KD Service Cart And KD Utility Cart

- Versatile, durable and economically-priced carts.
- Marine rails and lightly-textured polypropylene shelves keep contents in place.
- Aluminum uprights ensure stability.
- Ships “knocked down” to minimize shipping costs.
- Easy to assemble.

Cart and Shelf Panel Set Colors:
Black (110), Speckled Grey (480).

Trash Container and Silverware Holder
Color: Black (110).



Each BC340KD shelf holds one full-sized dish rack or two standard bus boxes.



Marine rails keep contents in place.

Optional shelf panels can be added at time of assembly to enclose three sides.

Sturdy aluminum uprights.

Four powder coated steel swivel casters provide quiet transport and steady maneuvering.

BC340KD

Durable, stain-resistant surface is easy to clean.



Shown with optional shelf panels on single shelf.

CODE	BC331KD	BC340KD
DESCRIPTION	Service Cart	Large Utility Cart
CASTER DIA./TYPE	10,2 cm, 4 swivel, no brake	12,7 cm, 4 swivel, no brake
OVERALL DIM. L x D x H	83,5 x 41,3 x 96,5 cm	101,5 x 54 x 95 cm
SHELF DIM. L x D x H	62 x 40 x 30 cm	80 x 52 x 29,8 cm
LOAD CAPACITY	136 kg	180 kg

Case Pack: 1

Optional Accessories



CODE	BC331KDTC	BC331KD5H	BC340KDP
DESCRIPTION	30 L Trash Container	9,5 L Silverware Holder	Single Shelf Panel Set (for BC340KD only).
DIM. W x D x H	33 x 24 x 56 cm	33 x 24 x 18,5 cm	80,3 x 45 x 29,8 cm

Case Pack: 1

Service Carts

- All-purpose versatile, durable and dependable workhorses.
- Ideal for use on the receiving dock or setting up and bussing tables.
- Made of one-piece, polyethylene with molded-in handles and shelves.
- Choose from models with open or enclosed sides.

Colors: Black (110), Slate Blue (401), Dark Brown (131), Coffee Beige (157), Grey (180), Granite Grey (191), Granite Green (192).

BC225, BC2254S, BC11TC and BC1115SH can be shipped by parcel carrier.



Open Carts



CODE	BC225	BC2254S	BC235
CASTER DIA./TYPE	7,6 cm, 2 fixed, 2 swivel, 1 w/brake	7,6 cm, 4 swivel, 1 w/brake	12,7 cm, 2 fixed, 2 swivel, 1 w/brake
OVERALL DIM. L x D x H	71 x 41 x 82 cm	71 x 41 x 82 cm	95 x 55 x 88 cm
SHELF DIM. L x D x H	56 x 39,5 x 29 cm	56 x 39,5 x 29 cm	79 x 52 x 29 cm
LOAD CAPACITY	159 kg	159 kg	227 kg

Case Pack: 1



CODE	BC2354S	BC230	BC2304S
CASTER DIA./TYPE	12,7 cm, 4 swivel, 1 w/brake	12,7 cm, 2 fixed, 2 swivel, 1 w/brake	12,7 cm, 4 swivel, 1 w/brake
OVERALL DIM. L x D x H	95 x 55 x 88 cm	84,5 x 51 x 88 cm	84,5 x 51 x 88 cm
SHELF DIM. L x D x H	79 x 52 x 29 cm	69 x 49,5 x 29 cm	69 x 49,5 x 29 cm
LOAD CAPACITY	227 kg	227 kg	227 kg

Case Pack: 1

Enclosed Carts



CODE	BC330	BC3304S
CASTER DIA./TYPE	12,7 cm, 2 fixed, 2 swivel, 1 w/brake	12,7 cm, 4 swivel, 1 w/brake
OVERALL DIM. L x D x H	84,5 x 51 x 88 cm	84,5 x 51 x 88 cm
SHELF DIM. L x D x H	69 x 46,5 x 29 cm	69 x 46,5 x 29 cm
LOAD CAPACITY	227 kg	227 kg

Case Pack: 1

Optional Accessories



CODE	BC11TC*	BC1115SH*
DESCRIPTION	42 L Trash Container	6,6 L Silverware Holder
DIMENSIONS W x D x H	35 x 20,6 x 53,7 cm	36,8 x 15,2 x 13,7 cm

Case Pack: 1 * BC11TC & BC1115SH will not fit KD Service or Utility Carts. BC11TC & BC1115SH are available in Black (110) and Dark Brown (131) only.



Shelving



Camshelving®

Camshelving High Density Storage System

Security Cage For Camshelving

Camshelving Wrap-around Security Cage

Pan Divider Bar for Camshelving®

Tray Slide Rack for Camshelving

Camshelving Drying Rack System

Camshelving Elements Series

Divider Bar for Elements Series

Camshelving Wall Shelves And StoreSafe® Shelf Extenders

Camshelving Basics Series

S-Series Dunnage Racks

Camshelving®



Easy and Quick to Clean



Easy to Adjust and Configure



Unquestionably Strong,
Durable and Stable



Rust Free

No Bolts,
No Nuts

CAMGUARD
ANTIMICROBIAL SHELF PLATES



Store and
Transport
Food Safely



Dishwasher Safe
Except mobile
parts.



Fit for Food
Products



Cadmium-Free



Recyclable
Polypropylene



Consultant Cut
Sheets and CAD
drawings are
available on
www.cambro.com

Camshelving is covered by EU Patent #0686817 A2.

Easy And Quick To Clean

For A Sanitary Storage Area

- Shelf plates are easy to remove and run through the dishwasher.
- Smooth polypropylene surface quickly wipes clean.
- Spills clean quickly and easily, reducing the risk of cross-contamination.
- Camshelving® is weldless, so liquids and dirt cannot get inside crevices.



Shelf plates can be placed in an open end Camrack® OETR314 and washed in a commercial dishwasher.

CAMGUARD

ANTIMICROBIAL SHELF PLATES

- Inhibits the growth of mold, fungus and bacteria.
- Camguard works continuously to suppress the growth of microbes between cleanings.
- All shelf plates are embedded with Camguard antimicrobial so it will not scrape off, wash off or wear out.



Strong And Durable

Strong As Steel

- Posts and traverses are the weight bearing components, constructed with a steel core and encapsulated by a thick polypropylene outer layer.
- Inner steel core ensures that Camshelving is strong, durable and stable.
- Thick, polypropylene outer layer will not chip, break or corrode.
- Post connectors provide exceptional cross stabilization.



Weight bearing components are made with a steel core.

Weight Bearing Capacity

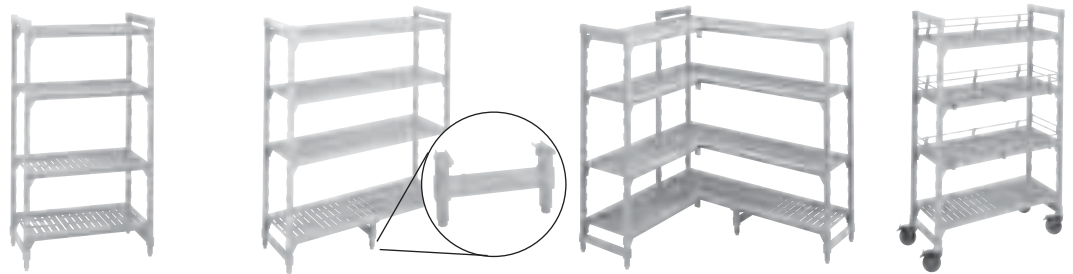

	SINGLE UNIT - 4 SHELVES	SINGLE UNIT - 4 SHELVES	DUNNAGE STAND	CORNER UNIT	MOBILE UNIT
TRAVERSE LENGTH	610 to 1220 mm	1370 to 1830 mm	1300 to 1830 mm	610 to 1220 mm	610 to 1220 mm
WEIGHT BEARING CAPACITY PER SHELF	363 kg	272 kg	454 kg	181 kg	—
WEIGHT BEARING CAPACITY PER UNIT WITH 4 SHELVES	1451 kg	1089 kg	—	726 kg	340 kg

Dunnage Stands are used only on the bottom shelf. Recommended for traverses 1370 mm or longer.

Corner Connectors are recommended for use on traverses 1220 mm or less.

Due to the weight bearing capacity of casters, maximum weight load on an entire Mobile Camshelving Unit is 340 kg.

Easy To Assemble & Adjust

Build Any Configuration and Fit Any Size Area

- Create a space efficient layout for any area.
- Assembles in minutes, requiring only the use of a mallet.
- Shelves can be adjusted in 100 mm increments without disassembling the entire unit.
- Two units can be connected together with shelves at alternating heights for maximum storage flexibility.
- Corner Connectors attach units to create a 90° angle or U shape.

POST HEIGHT	DOVETAIL INCREMENT	NUMBER OF POSITIONS PER POST
Stationary		
820 mm	100 mm	6
1430 mm	100 mm	12
1630 mm	100 mm	14
1830 mm	100 mm	16
2140 mm	100 mm	19
Mobile		
890 mm	100 mm	6
1500 mm	100 mm	12
1700 mm	100 mm	14
1910 mm	100 mm	16

EASY TO ADJUST!

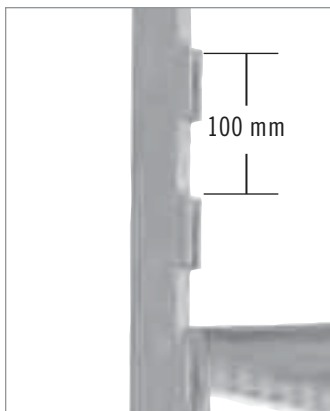

Shelves can be adjusted in 100 mm increments, without disassembling the unit.

EASY TO ASSEMBLE!

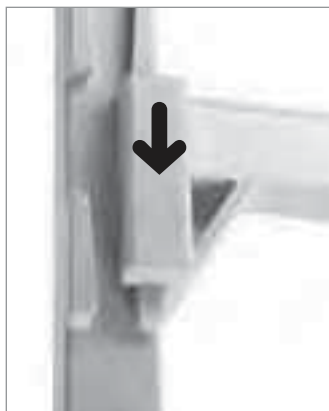

Traverses slide easily down onto dovetail.

Rust Free

For Use in Any Area, Wet or Dry

- Camshelving is weldless with no exposed metal, so it remains rust free.
- Safe to -38°C, making Camshelving the ideal shelving system for freezers, walk-ins or any wet or humid environment.
- Not even salt water or sea air will corrode Camshelving.

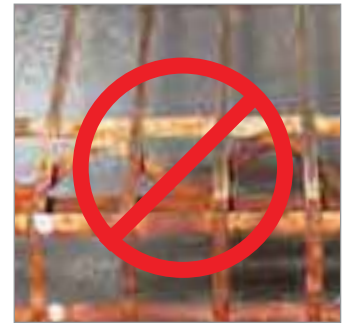

Lifetime limited warranty against rust and corrosion for traverses and stationary posts.

HACCP



Dry Storage Room



Cold Storage Room

Camshelving® Consulting



Free Camshelving Consulting Service

Cambro provides a free consulting service using our proprietary computer program. To contact the Camshelving Consulting Department, just call Cambro at

CAMBRO USA:
1(714) 230-4113
shelving@cambro.com

Provide the dimensions of the storage space, number of shelves per unit, height of the posts and any other special requirements you have. Cambro will provide a recommended floor plan and product order list. Your Cambro Distributor or Sales Representative will contact you with pricing. There is no cost or obligation to use the Cambro Consulting Service.

Components

Camshelving is a modular system that allows the flexibility to assemble shelving to fit any size area. The key components, including posts, post connectors, traverses and shelf plates, are available in a variety of sizes.

They can be easily configured to custom build shelving to maximize storage space. Unique design elements such as shared posts and corner connectors simplify assembly and increase storage capacity.

Traverses

Traverses have a steel core with a polypropylene exterior to provide strength and durability.

Traverses connect to the post by sliding on to the dovetail on the post.

Two traverses are needed to build one shelf, and they define the length of the unit.

Shelf Plates

Shelf Plates are made of polypropylene. Dishwasher safe.

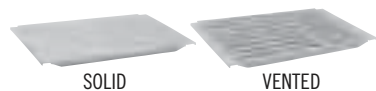

Shelf Kit
Includes two Traverses and Shelf Plates to fit the length of the Traverses.

SOLID
VENTED

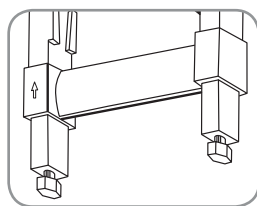

Posts For Stationary Unit

Posts have a steel core with a polypropylene exterior to provide strength and durability.

Posts define the height of the shelving unit and are measured with the leveling foot fully engaged.

Post for Stationary unit



Post Connectors

Post connectors hold two posts together and define the width of the unit.

They are made of polypropylene and provide excellent cross stabilization.

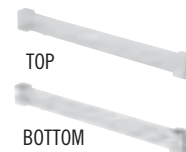

POST KIT
Includes two Posts and a set of one top and one bottom Post Connector.

Posts for Mobile Camshelving

Mobile Camshelving posts must be used to build mobile Camshelving units.



Casters

Available in standard for dry storage or premium for freezers, cold, or wet applications.

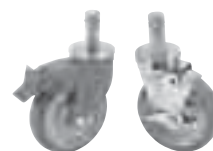

Maximize Space Utilization

Camshelving is available in starter and add-on units for ease of ordering and assembly.

Starter Units

- Available in stationary or mobile units.
- Starter units ship complete with two post kits, traverses and shelf plates to build an entire unit.

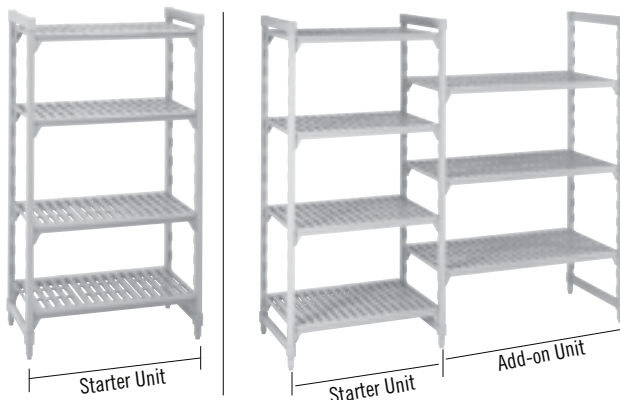

Add-On Units

- Add-On units ship complete with one post kit, traverses and shelf plates to attach to an adjoining unit.
- The traverses on both the first and second unit share the middle post.
- No add-on clips or S-hooks required.
- There is no loss of weight bearing capacity when built in a straight line.



Corner Unit & U Shape Units

- Corner connectors can be used to build corner units and U Shape units.
- Traverses snap onto corner connectors just like they snap onto the dovetails of the posts.

Corner Connector Set

- Attaches a basic unit to a second unit at a 90° angle or to form a U shape.
- A set of corner connectors are needed for each shelf.



* Corner connectors are recommended for use on traverses equal to or shorter than 1220 mm, and covered by U.S. Patent D498,664S.

Dunnage Stand

- Increases weight bearing capacity to 454 kg on the bottom shelf.
- Recommended for units 1380 mm or longer.



* Dunnage stands are covered by U.S. Patent US 6,981,454B2.

Fence System

- Prevents stored items from falling off shelving units.
- Ideal for mobile shelving.



Mobile Units

- Mobile Camshelving units are built by using posts for mobile carts and inserting casters.
- Mobile units are not designed to serve as transport carts.



Mobile unit shown with optional fencing.

Seismic Foot

- Bolts a post to the floor for a more stable base.
- Screws not included.



Wall Fastener

- Fastens a unit to a wall as a safety precaution.
- Screws not included.



Identification Tag

- Easily clips onto traverses to identify stored items.
- Made of PVC.
- Includes 12 HACCP labels.



Donut Bumper

- Protects mobile Camshelving.
- 90 mm Bumper.



Camshelving® Footprint Dimensions

- The following charts are provided to assist in developing a footprint for your storage area.
- They can also be used to help determine your actual shelf space.
- Traverse measurements are based on outside, or overall unit length.
- This includes the posts.
- The overall length varies slightly when using a basic unit, add-on unit, intermediate unit or corner unit.
- These variations are outlined below.

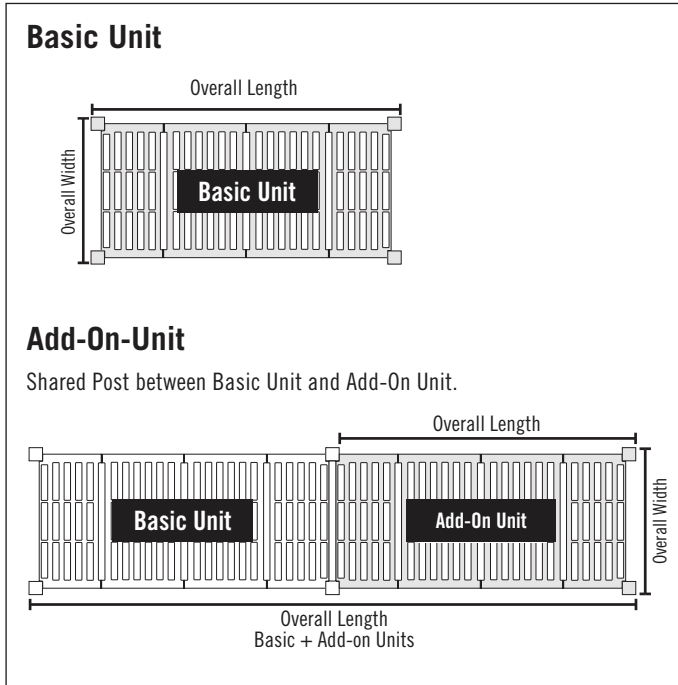

UNIT	BASIC UNIT OVERALL LENGTH	ADD-ON UNIT OVERALL LENGTH	BASIC + ADD-ON UNIT OVERALL LENGTH
610 mm	610 mm	565 mm	1175 mm
760 mm	760 mm	720 mm	1480 mm
910 mm	910 mm	870 mm	1780 mm
1070 mm	1070 mm	1025 mm	2095 mm
1220 mm	1220 mm	1175 mm	2395 mm
1380 mm	1380 mm	1330 mm	2710 mm
1530 mm	1530 mm	1480 mm	3010 mm
1830 mm	1830 mm	1790 mm	3620 mm

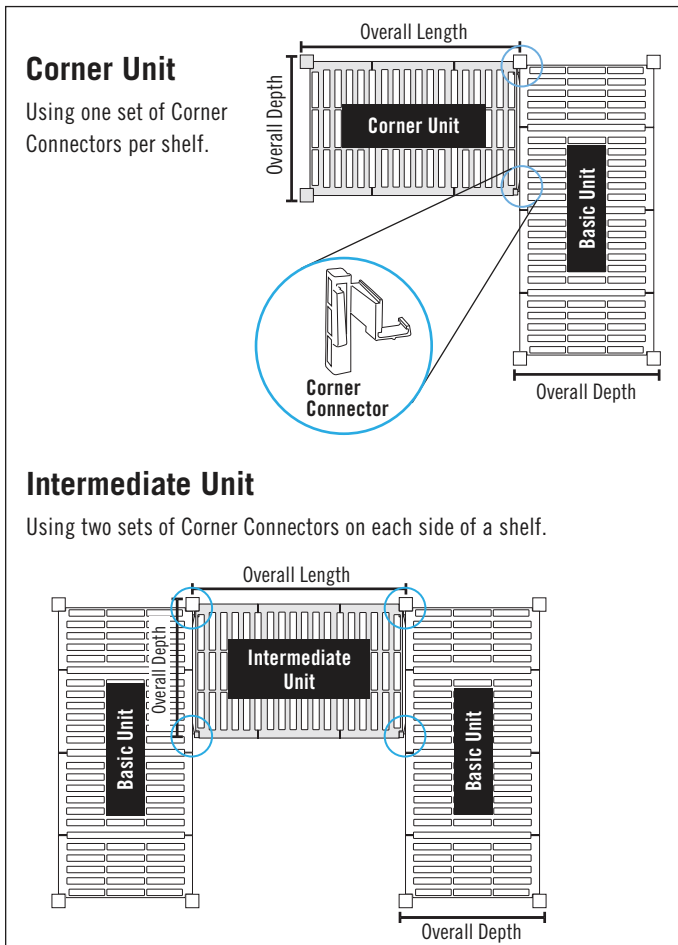

UNIT	CORNER UNIT OVERALL LENGTH	INTERMEDIATE UNIT OVERALL LENGTH
610 mm	585 mm	560 mm
760 mm	740 mm	715 mm
910 mm	890 mm	865 mm
1070 mm	1045 mm	1020 mm
1220 mm	1195 mm	1170 mm

Corner Connectors are recommended for use on traverses 1220 mm or less.

Shelf Spacing

Dovetails are spaced every 100 mm



POST HEIGHT	DOVETAIL INCREMENT	NUMBER OF POSITIONS PER POST
Stationary		
820 mm	100 mm	6
1430 mm	100 mm	12
1630 mm	100 mm	14
1830 mm	100 mm	16
2140 mm	100 mm	19
Mobile		
890 mm	100 mm	6
1500 mm	100 mm	12
1700 mm	100 mm	14
1910 mm	100 mm	16

Stationary Post Kits

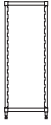

HEIGHT	WIDTH	360 mm	460 mm	540 mm	610 mm
820 mm	CODE	CSPK1432	CSPK1832	CSPK2132	CSPK2432
1430 mm	CODE	CSPK1456	CSPK1856	CSPK2156	CSPK2456
1630 mm	CODE	CSPK1464	CSPK1864	CSPK2164	CSPK2464
1830 mm	CODE	CSPK1472	CSPK1872	CSPK2172	CSPK2472
2140 mm	CODE	CSPK1484	CSPK1884	CSPK2184	CSPK2484

Case Pack: 1 Color: Speckled Gray (480).

Solid Shelf Kits



WIDTH	LENGTH	610 mm	760 mm	910 mm	1070 mm	1220 mm	1380 mm	1530 mm	1830 mm
360 mm	CODE	CS1424SK	CS1430SK	CS1436SK	CS1442SK	CS1448SK	CS1454SK	CS1460SK	CS1472SK
460 mm	CODE	CS1824SK	CS1830SK	CS1836SK	CS1842SK	CS1848SK	CS1854SK	CS1860SK	CS1872SK
540 mm	CODE	CS2124SK	CS2130SK	CS2136SK	CS2142SK	CS2148SK	CS2154SK	CS2160SK	CS2172SK
610 mm	CODE	CS2424SK	CS2430SK	CS2436SK	CS2442SK	CS2448SK	CS2454SK	CS2460SK	CS2472SK

Case Pack: 1 Color: Speckled Gray (480).

Vented Shelf Kits



WIDTH	LENGTH	610 mm	760 mm	910 mm	1070 mm	1220 mm	1380 mm	1530 mm	1830 mm
360 mm	CODE	CS1424VK	CS1430VK	CS1436VK	CS1442VK	CS1448VK	CS1454VK	CS1460VK	CS1472VK
460 mm	CODE	CS1824VK	CS1830VK	CS1836VK	CS1842VK	CS1848VK	CS1854VK	CS1860VK	CS1872VK
540 mm	CODE	CS2124VK	CS2130VK	CS2136VK	CS2142VK	CS2148VK	CS2154VK	CS2160VK	CS2172VK
610 mm	CODE	CS2424VK	CS2430VK	CS2436VK	CS2442VK	CS2448VK	CS2454VK	CS2460VK	CS2472VK

Case Pack: 1 Color: Speckled Gray (480).

Vented Starter Units

WIDTH 460 mm



HEIGHT	LENGTH	910 mm	1070 mm	1220 mm	1380 mm	1530 mm
4 Shelves						
1630 mm	CODE	CSU48366	CSU48426	CSU48486	CSU48546	CSU48606
1830 mm	CODE	CSU48367	CSU48427	CSU48487	CSU48547	CSU48607
5 Shelves						
1630 mm	CODE	CSU58366	CSU58426	CSU58486	CSU58546	CSU58606
1830 mm	CODE	CSU58367	CSU58427	CSU58487	CSU58547	CSU58607

Case Pack: 1

Color: Speckled Gray (480).

Vented Add-On Units

WIDTH 460 mm



HEIGHT	LENGTH	910 mm	1070 mm	1220 mm	1380 mm	1530 mm
4 Shelves						
1630 mm	CODE	CSA48366	CSA48426	CSA48486	CSA48546	CSA48606
1830 mm	CODE	CSA48367	CSA48427	CSA48487	CSA48547	CSA48607
5 Shelves						
1630 mm	CODE	CSA58366	CSA58426	CSA58486	CSA58546	CSA58606
1830 mm	CODE	CSA58367	CSA58427	CSA58487	CSA58547	CSA58607

Case Pack: 1

Color: Speckled Gray (480).

Vented Starter Units

WIDTH 540 mm



HEIGHT	LENGTH	910 mm	1070 mm	1220 mm	1380 mm	1530 mm
4 Shelves						
1630 mm	CODE	CSU41366	CSU41426	CSU41486	CSU41546	CSU41606
1830 mm	CODE	CSU41367	CSU41427	CSU41487	CSU41547	CSU41607
5 Shelves						
1630 mm	CODE	CSU51366	CSU51426	CSU51486	CSU51546	CSU51606
1830 mm	CODE	CSU51367	CSU51427	CSU51487	CSU51547	CSU51607

Case Pack: 1

Color: Speckled Gray (480).

Vented Add-On Units

WIDTH 540 mm



HEIGHT	LENGTH	910 mm	1070 mm	1220 mm	1380 mm	1530 mm
4 Shelves						
1630 mm	CODE	CSA41366	CSA41426	CSA41486	CSA41546	CSA41606
1830 mm	CODE	CSA41367	CSA41427	CSA41487	CSA41547	CSA41607
5 Shelves						
1630 mm	CODE	CSA51366	CSA51426	CSA51486	CSA51546	CSA51606
1830 mm	CODE	CSA51367	CSA51427	CSA51487	CSA51547	CSA51607

Case Pack: 1

Color: Speckled Gray (480).

Vented Starter Units

WIDTH 610 mm



HEIGHT	LENGTH	910 mm	1070 mm	1220 mm	1380 mm	1530 mm
4 Shelves						
1630 mm	CODE	CSU44366	CSU44426	CSU44486	CSU44546	CSU44606
1830 mm	CODE	CSU44367	CSU44427	CSU44487	CSU44547	CSU44607
5 Shelves						
1630 mm	CODE	CSU54366	CSU54426	CSU54486	CSU54546	CSU54606
1830 mm	CODE	CSU54367	CSU54427	CSU54487	CSU54547	CSU54607

Case Pack: 1

Color: Speckled Gray (480).

Vented Add-On Units

WIDTH 610 mm



HEIGHT	LENGTH	910 mm	1070 mm	1220 mm	1380 mm	1530 mm
4 Shelves						
1630 mm	CODE	CSA44366	CSA44426	CSA44486	CSA44546	CSA44606
1830 mm	CODE	CSA44367	CSA44427	CSA44487	CSA44547	CSA44607
5 Shelves						
1630 mm	CODE	CSA54366	CSA54426	CSA54486	CSA54546	CSA54606
1830 mm	CODE	CSA54367	CSA54427	CSA54487	CSA54547	CSA54607

Case Pack: 1

Color: Speckled Gray (480).

Vented Starter Units

Due to heavy weight of 2140 mm shelving, starter and add-on units will be shipped in two separate cartons.

WIDTH 610 mm



HEIGHT	LENGTH	910 mm	1070 mm	1220 mm	1380 mm	1530 mm
5 Shelves						
2140 mm	CODE	CSU54368PKG	CSU54428PKG	CSU54488PKG	CSU54548PKG	CSU54608PKG
	POST KIT BOX	Set of 2 post kits	Set of 2 post kits	Set of 2 post kits	Set of 2 post kits	Set of 2 post kits
	SHELF KIT BOX	Set of 5 shelf kits	Set of 5 shelf kits	Set of 5 shelf kits	Set of 5 shelf kits	Set of 5 shelf kits
		Case Pack: 1	Color: Speckled Gray (480).			

Vented Add-on Units

WIDTH 610 mm



HEIGHT	LENGTH	910 mm	1070 mm	1220 mm	1380 mm	1530 mm
5 Shelves						
2140 mm	CODE	CSA54368PKG	CSA54428PKG	CSA54488PKG	CSA54548PKG	CSA54608PKG
	POST KIT BOX	Set of 1 post kit	Set of 1 post kit	Set of 1 post kit	Set of 1 post kit	Set of 1 post kit
	SHELF KIT BOX	Set of 5 shelf kits	Set of 5 shelf kits	Set of 5 shelf kits	Set of 5 shelf kits	Set of 5 shelf kits
		Case Pack: 1	Color: Speckled Gray (480).			

Dunnage Stands

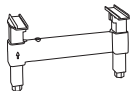

HEIGHT	WIDTH	360 mm	460 mm	540 mm	610 mm
165 mm	CODE	CSDS14	CSDS18	CSDS21	CSDS24
		Case Pack: 1	Color: Speckled Gray (480).		

Accessories

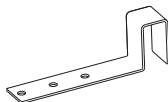

	Seismic Foot	Wall Fastener	Corner Connectors	ID Tag	ID Tag
CODE	CSEQ3	CSWF	CSCC	CSID	CSID3
DESCRIPTION	Seismic Foot	Wall Fastener	90° Left & Right	150 mm ID Tag	80 mm ID Tag
COLOR	Silver	Silver	Speckled Gray (480)	White/Clear	White/Clear
SIZE: L x W x H	100 x 85 x 60 mm	238 x 48 x 73 mm	—	25 x 150 mm	25 x 80 mm
CASE PACK	4 each	4 each	1 set of 2 parts	12 each	12 each



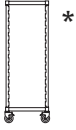



Mobile Post Kits & Casters



HEIGHT (with casters)	WIDTH	460 mm	540 mm	610 mm
890 mm	CODE	CSPRK1835	CSPRK2135	CSPRK2435
1500 mm	CODE	CSPRK1859	CSPRK2159	CSPRK2459
1700 mm	CODE	CSPRK1867	CSPRK2167	CSPRK2467
1910 mm	CODE	CSPRK1875	CSPRK2175	CSPRK2475

Case Pack: 1 Color: Speckled Gray (480).
* Casters are not included and must be ordered separately.

Casters

						
DIAMETER	127 mm	127 mm	127 mm	127 mm	127 mm	90 mm
	Premium	Premium	Standard	Standard	Standard	—
CODE	CSCSL	CSTL	CSSB	CSCS	CSCR	CSRDB
DESCRIPTION	Swivel with lock in one direction	Total Locking Caster	Swivel Chrome with Brake	Swivel Chrome Caster	Rigid Chrome Caster	Donut Bumper
CASE PACK	2	2	2	2	2	4

PREMIUM CASTERS

The premium line is made with a zinc plated post and a non-marking polyurethane wheel. Recommended for use in wet areas or in walk-in refrigerators and freezers.

STANDARD CASTERS

The standard casters are chrome plated and can be used for dry storage.

Fence System for Camshelving®

Double Level
Traverse Fence
100 mm



FITS TRAVERSE	610 mm	760 mm	910 mm	1070 mm	1220 mm	1380 mm	1530 mm	1830 mm
CODE	CSFT242	CSFT302	CSFT362	CSFT422	CSFT482	CSFT542	CSFT602	CSFT722
# OF BRACKETS	2	2	2	3	4	4	4	5
# OF RODS	2	2	2	2	2	2	2	2

Single Level
Traverse Fence
50 mm



FITS TRAVERSE	610 mm	760 mm	910 mm	1070 mm	1220 mm	1380 mm	1530 mm	1830 mm
CODE	CSFT241	CSFT301	CSFT361	CSFT421	CSFT481	CSFT541	CSFT601	CSFT721
# OF BRACKETS	2	2	2	3	3	4	4	5
# OF RODS	1	1	1	1	1	1	1	1

End Fence



FITS POST CONNECTOR	360 mm	460 mm	540 mm	610 mm
CODE	CSFE14	CSFE18	CSFE21	CSFE24
# OF BRACKETS	2	2	2	2
# OF RODS	2	2	2	2

Case Pack: 1 Color: Speckled Gray (480).

Vented Mobile Starter Units

DEPTH 460 mm



HEIGHT (with casters)		LENGTH	910 mm	910 mm	1070 mm	1070 mm	1220 mm	1220 mm
4 Shelves			Premium	Standard	Premium	Standard	Premium	Standard
1700 mm	CODE		CSUR48366	CSURS48366	CSUR48426	CSURS48426	CSUR48486	CSURS48486
1910 mm	CODE		CSUR48367	CSURS48367	CSUR48427	CSURS48427	CSUR48487	CSURS48487
5 Shelves								
1700 mm	CODE		CSUR58366	CSURS58366	CSUR58426	CSURS58426	CSUR58486	CSURS58486
1910 mm	CODE		CSUR58367	CSURS58367	CSUR58427	CSURS58427	CSUR58487	CSURS58487

Case Pack: 1 **Color:** Speckled Gray (480).

Premium Casters: include two non-corrosive Swivel Locking Casters (CSCSL) and two Total Locking Casters (CSCTL).

Standard Casters: include two Swivel Chrome Casters (CSCS) and two Swivel Chrome with Brakes (CSSB).

DEPTH 540 mm



HEIGHT (with casters)		LENGTH	910 mm	910 mm	1070 mm	1070 mm	1220 mm	1220 mm
4 Shelves			Premium	Standard	Premium	Standard	Premium	Standard
1700 mm	CODE		CSUR41366	CSURS41366	CSUR41426	CSURS41426	CSUR41486	CSURS41486
1910 mm	CODE		CSUR41367	CSURS41367	CSUR41427	CSURS41427	CSUR41487	CSURS41487
5 Shelves								
1700 mm	CODE		CSUR51366	CSURS51366	CSUR51426	CSURS51426	CSUR51486	CSURS51486
1910 mm	CODE		CSUR51367	CSURS51367	CSUR51427	CSURS51427	CSUR51487	CSURS51487

Case Pack: 1 **Color:** Speckled Gray (480).

Premium Casters: include two non-corrosive Swivel Locking Casters (CSCSL) and two Total Locking Casters (CSCTL).

Standard Casters: include two Swivel Chrome Casters (CSCS) and two Swivel Chrome with Brakes (CSSB).

DEPTH 610 mm



HEIGHT (with casters)		LENGTH	910 mm	910 mm	1070 mm	1070 mm	1220 mm	1220 mm
4 Shelves			Premium	Standard	Premium	Standard	Premium	Standard
1700 mm	CODE		CSUR44366	CSURS44366	CSUR44426	CSURS44426	CSUR44486	CSURS44486
1910 mm	CODE		CSUR44367	CSURS44367	CSUR44427	CSURS44427	CSUR44487	CSURS44487
5 Shelves								
1700 mm	CODE		CSUR54366	CSURS54366	CSUR54426	CSURS54426	CSUR54486	CSURS54486
1910 mm	CODE		CSUR54367	CSURS54367	CSUR54427	CSURS54427	CSUR54487	CSURS54487

Case Pack: 1 **Color:** Speckled Gray (480).

Premium Casters: include two non-corrosive Swivel Locking Casters (CSCSL) and two Total Locking Casters (CSCTL).

Standard Casters: include two Swivel Chrome Casters (CSCS) and two Swivel Chrome with Brakes (CSSB).

Camshelving® High Density Storage System

High Density Camshelving maximizes storage capacity by eliminating aisles and utilizing all available space. Ideal for operations with limited space or that need to use their space more effectively. Floor track system provides safe and easy access to stored product. Heavy weight loads roll securely on raised floor track.



COMPONENT

Increases Storage Capacity up to **40%**

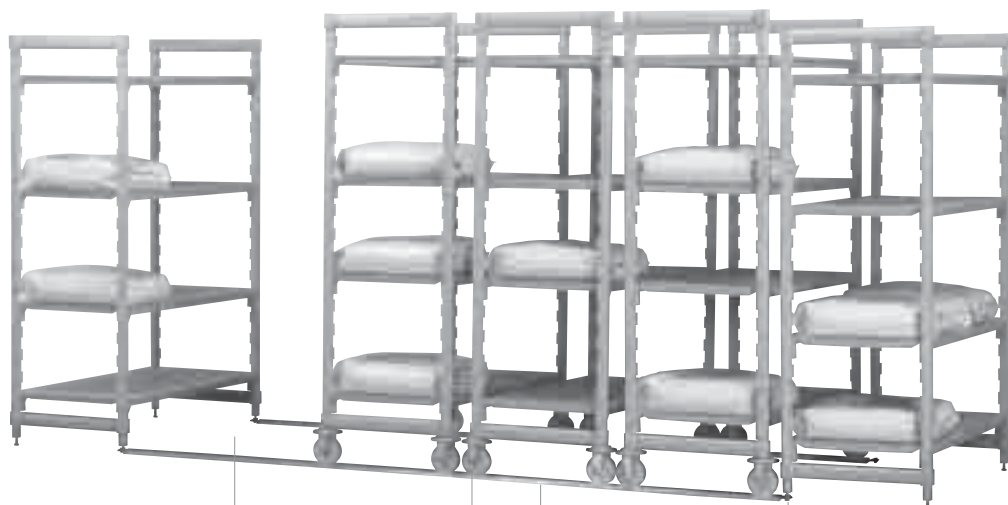

Easy to Clean

- Camshelving is the most hygienic high density storage system available.
- Raised track ensures dirt will not get trapped, and is easy to clean.
- Aluminum track and stainless steel hardware are rust resistant.
- Shelf plates easily wipe clean or can be removed and run through the dishwasher.

Ergonomic Access to Stored Product

Active aisle of 76,2 cm-91,44 cm provides easy access to all stored product. Low profile sloped rail design ensures easy access to product using the active aisle.



Roll Easily and Securely
Grooved casters roll easily and securely on raised track. Can be used on any surface, including tile and choppy floors.

Raised Track

Raised track provides a smooth and level surface to easily roll mobile units. It ensures dirt will not get trapped, and is easy to clean. Mobile Units with heavy weight loads roll smoothly on track.



Easy Glide Floor Tracks

The track simply connects to the bottom of the Stationary Camshelving Unit. No bolts or drilling into the floor are required.

Camshelving® High Density Storage System

Easy to Order

- Camshelving stationary units act as the system anchor.
- Mobile units with exclusive high density casters are available with vented or solid shelves.
- Mobile units can be ordered in convenient starter units, or custom built using Camshelving mobile post kits, shelf kits and high density casters.*

- Raised track kits ship with all hardware necessary for installation.

* Refer components pages to build custom size Camshelving units.

Easy to Configure and Assemble

1. Determine your room size and needs. Multiple track kits can be used together to build the desired length of track.**
2. Choose starter unit size. Existing Camshelving stationary units can be retrofitted and utilized as the system anchors.
3. Choose high density mobile units, either starter units or build custom size units.
4. Different width stationary and mobile units may be used in single run of track.

** It is recommended to use a stationary unit for every 4,6 m of track to further stabilize the system.

System Components

- A Stationary Units
- B Mobile Units
- C Track
- D Active Aisle

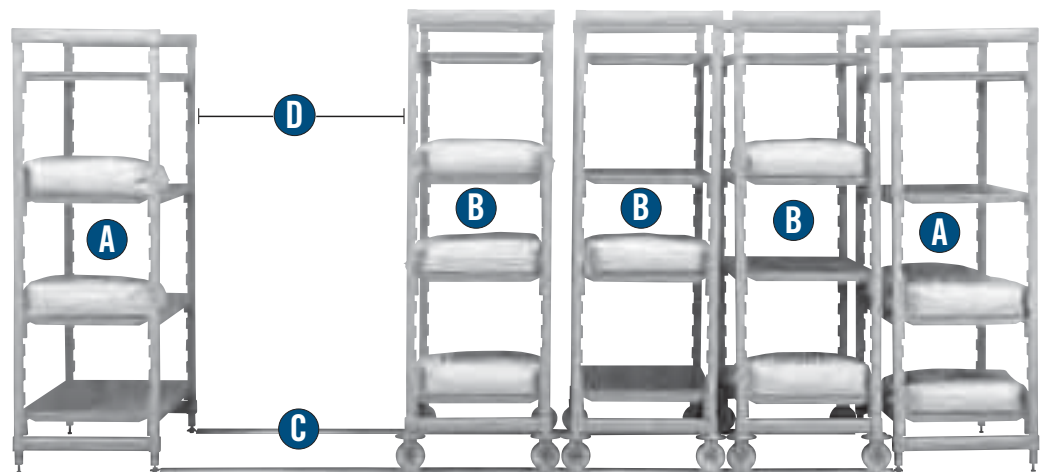

High Density Mobile Units include 4 High Density Casters.
Weight bearing capacity of High Density Mobile Camshelving Units is 340 kg.
It is recommended to use Fencing with High Density Camshelving. Refer to Fencing page for product details.

All necessary hardware is included in the track kit.

CODE	DESCRIPTION	SIZE
Track Kits		
CSHDTK10	3,05 m Track Kit for 3 Mobile Units*	3050 mm
CSHDTK12	3,66 m Track Kit for 4 Mobile Units*	3660 mm
CSHDTK145	4,42 m Track Kit for 5 Mobile Units*	4420 mm

High Density Mobile Starter Units with Vented Shelves		
CSUHD44486	Mobile Unit 4 Vented Shelves	610 x 1220 x 1700 mm
CSUHD44487	Mobile Unit 4 Vented Shelves	610 x 1220 x 1910 mm
CSUHD44427	Mobile Unit 4 Vented Shelves	610 x 1070 x 1910 mm
CSUHD44367	Mobile Unit 4 Vented Shelves	610 x 910 x 1910 mm

High Density Mobile Starter Units with Solid Shelves		
CSUHD44486S	Mobile Unit 4 Solid Shelves	610 x 1220 x 1700 mm
CSUHD44487S	Mobile Unit 4 Solid Shelves	610 x 1220 x 1910 mm
CSUHD44427S	Mobile Unit 4 Solid Shelves	610 x 1070 x 1910 mm
CSUHD44367S	Mobile Unit 4 Solid Shelves	610 x 910 x 1910 mm

Case Pack: 1 Color: Speckled Gray (480) Track Kits Color: (000)

CODE	DESCRIPTION	CASE PACK
Accessories		
CSHDDB	High Density Donut Bumper	4
CSHDC	High Density Caster	2
CSHDFF	Floor Fastener	4

Color: Speckled Gray (480). Track Kits Color: (000). * Track holds up to 610 cm wide mobile units.

Security Cage For Camshelving®

- Provides safe storage for valuables such as steaks, seafood, wine, champagne and spirits.
- Stainless steel material is safe for use in coolers and freezers.
- Ideal for securing personal items such as purses and backpacks.
- Unique modular design provides the flexibility to retrofit one shelf at a time or an entire shelving unit.

Ideal for use in coolers and freezers.



Fits on Metric Camshelving and Elements Series Units 60 cm wide, 120 cm in length and longer.

CODE

CSSC2448

DIMENSIONS L x W x H

64 x 108 x 46 cm

Case Pack: 1 Padlock not included.

Camshelving® Full-Wrap Security Cage

This heavy duty security cage provides safe storage from loss of pilferage for valuables such as steaks, seafood, wine, exotic fruits, vegetables, champagne and spirits. It's also ideal for securely storing high volume items that can "walk away" such as bottled water and sodas.

- Ideal for securing items on an entire shelving unit, maintains stored items visible at all times, making it easy to check inventory.
- The cage is designed with joining panels and can be installed in a new or existing Camshelving Stationary or Mobile unit.
- Security cage is designed for use with a padlock or combination lock.



CSSUM244867PKG

Unit Weight:
CSSUM244867PKG
83,94 kg
CSSU244864PKG
80,44 kg

CODE

CSSUM244867PKG

DESCRIPTION

Camshelving Full-Wrap Mobile Security Cage

DIMENSIONS L x W x H

1276 x 680 x 1721 mm

CSSU244864PKG

Camshelving Full-Wrap Stationary Security Cage

1276 x 680 x 1638 mm

CSSU2448

Full-wrap Security Unit Only

1276 x 680 x 1562 mm

Case Pack: 1 Color: Speckled Gray (480).

Pan Divider Bar for Camshelving®

- Create custom storage units that accommodate a variety of storage products and sizes on a single Camshelving unit.
- Angled and straight designs hold pans and boxes straight or on an angle for more ergonomic reach.
- Divider bars fit on 610 mm wide Camshelving units and hold up to 91 kg. per shelf.
- Divider bars feature a raised bar on the edge to keep racks and pans from sliding off the front of the unit.



Camracks® fit on divider bars to create a warewashing drying and storage station.

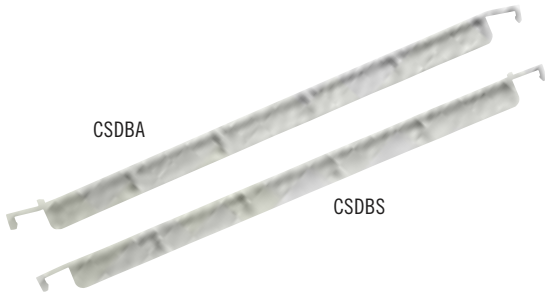

Divider bars can accommodate any size food pans from GN 1/1 to GN 1/9.

CODE	DESCRIPTION
CSDBA	Divider Bar Angled
CSDBS	Divider Bar Straight

Case Pack: 4 Color: Speckled Gray (480).

Tray Slide Rack for Camshelving®

- Holds six 46 x 66 cm sheet pans.
- Made from Aluminum which is safe for use in coolers and freezers.
- Fits on Camshelving units 610 mm wide and 610 mm in length or longer.

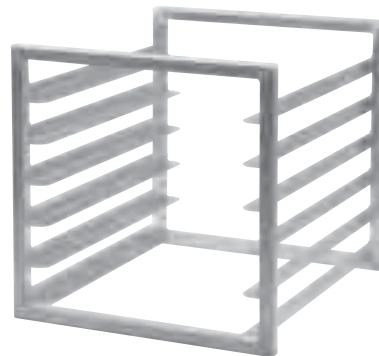

CODE	DIMENSIONS
	D x L x H
CSTSR	52,71 x 59,05 x 51,44 cm

Case Pack: 1 Color: (000).

Camshelving® Drying Rack System



- 7-Slot Rack securely holds trays, cutting boards, lids, baking sheet pans (full and half size) and plates 203 to 343 mm diameter during drying process.
- Provides convenient, sanitary storage, maximizes holding space and easy access.
- Lifetime warranty against rust and corrosion on Posts and Traverses.
- Promotes safety by eliminating moisture.
- Allows sufficient air circulation (Maximum product width 33 mm).
- Tray Drying Racks fit all 610 mm wide CS Camshelving, Camshelving Elements, Mobile or Stationary units Camshelving Basics stationary 760 to 1530 mm in length.

Drying Rack Color: Soft Gray (151).

Camshelving Drying Rack System is covered by U.S. Patent D 663,912 S.



COMPONENT



CSDR7
Tray Drying Rack

Drying Racks

CODE	DIMENSIONS L x W x H	CASE PACK
CSDR7	594 x 240 x 96,52 mm	1
CSDR73	594 x 240 x 96,52 mm	3

Color: Soft Gray (151). Shelf Plates not Included.



EDRC244878PKG
Elements Drying
Rack System



CSDRC244875PKG
Camshelving Drying
Rack System

Drying Rack Mobile Units

CODE	DIMENSIONS L x W x H
Camshelving® Drying Rack Mobile Units	
CSDRC244875PKG	1220 x 610 x 1910 mm
CSDRC246075PKG	1530 x 610 x 1910 mm
Camshelving® Elements Drying Rack Mobile Units	
EDRC244878PKG	1220 x 610 x 1910 mm
EDRC246078PKG	1530 x 610 x 1910 mm

Camshelving® Drying Rack Mobile Unit Color: Speckled Gray (480).

Camshelving® Elements Rack Mobile Unit Color: Brushed Graphite (580).

Package Includes: Drying Racks for three levels, six mobile traverses, two mobile post kits, premium casters (2 swivel, no brake, 2 swivel with brake) and instruction manual.

Drying Racks Holding Capacity

Total Pieces based on 3-level Shelf Units

SHELF SIZE W x L	RACKS PER SHELF	TOTAL PIECES	SHELF SIZE W x L	RACKS PER SHELF	TOTAL PIECES
610 x 610 mm	2	42	610 x 1220 mm	4	84
610 x 760 mm	2	42	610 x 1380 mm	4	84
610 x 910 mm	3	63	610 x 1530 mm	5	105
610 x 1070 mm	3	63	610 x 1830 mm	6	126

Camshelving®

ELEMENTS SERIES



The Future of Shelving

Strong as Steel

State-of-the-art, composite material is as strong as steel.

Lifetime Warranty

Lifetime warranty against rust and corrosion, ideal for use in cold, hot, wet and dry environments.

Easy To Clean

Dishwasher safe, removable shelf plates are embedded with Camguard® antimicrobial protection.



Camshelving® Elements Series

STRONG TECHNOLOGY



- Composite material is as strong as steel.
- 1980 mm stationary traverse is the longest and strongest in the industry; supports loads up to 272 kg per shelf.
- 60% lighter in weight than steel; easy to set up, adjust and change configurations.
- Resistant to moisture; won't rust or corrode.

HYGIENIC DESIGN

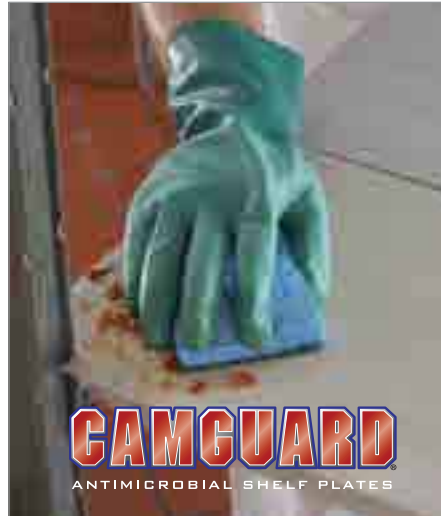

- Non-porous surface simply wipes clean.
- Shelf plates are easily removed for thorough dishwasher cleaning.
- Camguard® Antimicrobial protection is permanently embedded in shelf plates.
- Camguard works continuously to suppress the growth of microbes between cleanings.

SHELVING FOR LIFE



- Lifetime warranty against corrosion and rust.
- Withstands temperatures as cold as -38 °C or warm environments up to 88 °C.
- Ideal for wet, dry, cold or humid environments.
- Impervious to moisture and chemicals.
- Won't peel, dent or warp; corrosion resistant.

Weight Capacity

	TRAVERSE LENGTH (mm)	US self certification weight bearing capacity		TÜV certification weight bearing capacity	
		PER SHELF	PER UNIT	PER SHELF	PER UNIT
Single Unit	610 - 1220	363 kg	1451 kg	350 kg	1400 kg
	1380 - 1530	272 kg	1089 kg	275 kg	1100 kg
	1830	272 kg	1089 kg	225 kg	900 kg
	1980	272 kg	1089 kg	200 kg	800 kg
Dunnage Stand	1380 - 1980	454 kg bottom shelf only	—	—	—
Corner Unit (4 shelves)	610 - 1220	181 kg	726 kg	—	—
Mobile Unit (4 shelves)	910 - 1530	—	409 kg	—	—

Dunnage Stands are recommended for units 1380 mm or longer.
 Corner Connectors are recommended for use on traverses 1220 mm or less.
 Due to the weight bearing capacity of casters, maximum weight load on an entire Mobile Elements unit is 409 kg.



Camshelving® Elements Series Stationary Traverse Dovetails are covered by Patent # D 623,929.
 Camshelving® Elements Series Stationary Traverse Corner Connectors are covered by Patent # D 624,764.
 Other Camshelving® Elements Series Components are Patent Pending.

Maximize Space Utilization

Elements is available in partially assembled starter and add-on units for ease of ordering and assembly.

4-Shelf Stationary Starter Units

- Ship complete in one box with two post kits, 8 stationary traverses, 32 stationary dovetails and shelf plates to build one entire unit.



Dunnage Stand

- Increases weight bearing capacity to 454 kg on the bottom shelf.
- Recommended for units 1380 mm or longer.

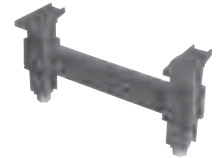

4-Shelf Add-On Units

- Ship complete in one box with one post kit, 8 traverses, 32 dovetails and shelf plates to attach to an adjoining unit.
- The traverses on both units share the middle posts, maximizing space.
- No add-on clips or S-hooks required.
- No loss of weight bearing capacity when built in a straight line.



Seismic Foot

- Bolts a post to the floor for a more stable base.
- Screws not included.



Corner Units & U-Shape Units

- Corner connectors can be used to build Corner and U-Shaped units.
- Corner connectors easily snap onto traverses.
- Corner connector set attaches a starter unit to a second unit at a 90° angle or to form a U-shape.
- A set of corner connectors are needed for each shelf.



Corner connectors are recommended for use on traverses equal to or shorter than 1220 mm, and are covered by U.S. Patent D624,764.

Wall Fastener

- Fastens a unit to a wall as a safety precaution.
- Screws not included.



Identification Tag

- Easily clips onto traverses to identify stored items.
- Made of PVC.
- Includes 12 HACCP labels.



4-Shelf Mobile Starter Units

- Mobile starter units ship complete with 2 post kits, 8 mobile traverses, 32 mobile dovetails, shelf plates and 4 casters.
- Mobile traverses feature a 45° gusset for maximum cross-stabilization.
- Available with standard or premium casters.
- Mobile units are not designed to serve as transport carts.
- Mobile traverses and mobile dovetails are required to build a Mobile Elements Series Unit.



Donut Bumper

- Protects posts and casters.
- 127 mm Bumper.



Camshelving® Elements Series Configuration Details

- The following charts are provided to assist in developing a footprint for your storage area.
- They can also be used to help determine your actual shelf space.
- Shelf measurements are based on outside, or overall unit length and width including the posts.
- The overall length varies slightly when using an add-on, intermediate or corner unit.
- These variations are outlined below.

Shelf Spacing

Notches for dovetails are spaced every 100 mm.

POST HEIGHT	NUMBER OF POSITIONS PER POST	POST HEIGHT WITH CASTER	NUMBER OF POSITIONS PER POST
Stationary		Mobile	
1630 mm	14	1778 mm	14
1830 mm	16	1980 mm	16
2140 mm	19		

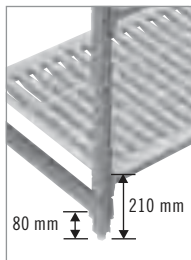

Easy To Adjust

Build Any Configuration and Fit Any Size Area

- Create a space efficient layout for any area.
- Assembles requiring only the use of a rubber mallet.
- Shelves can be adjusted in 100 mm increments without disassembling the entire unit.
- Two units can be connected together by sharing posts with shelves at alternating heights for maximum storage flexibility.
- Corner Connectors attach units to create a 90° angle or U-shape.

POST HEIGHT	DOVETAIL INCREMENT	NUMBER OF POSITIONS PER POST
Stationary		
1630 mm	100 mm	14
1830 mm	100 mm	16
2140 mm	100 mm	19
Mobile		
1778 mm	100 mm	14
1980 mm	100 mm	16

Shelving Consulting

Cambro provides a free consulting service to maximize your storage area. No cost or obligation.



1. Simply provide the dimensions of the storage space, number of shelves per unit, height of the posts, and any additional requirements you have.
2. Cambro will provide a recommended floor plan, 3-D view and product order list in Excel.
3. Your Cambro distributor or sales representative will contact you with pricing.
4. To contact the Camshelving Consulting Department, please call, CAMBRO USA: 1(714) 230-4113 shelving@cambro.com

Starter Unit

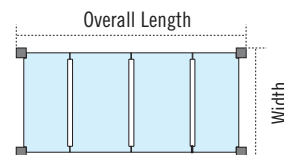

Add-on Unit

Shared posts between starter unit and add-on unit maximize space.

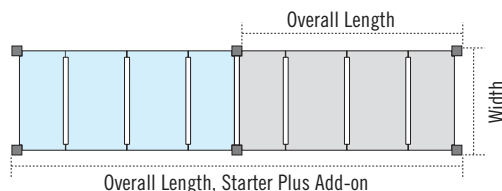

Corner Unit

Using one set of Corner Connectors per shelf.

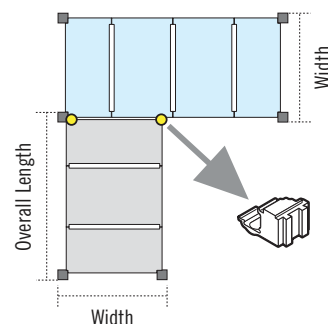

U-Shaped Unit

Requires two sets of corner connectors per shelf.

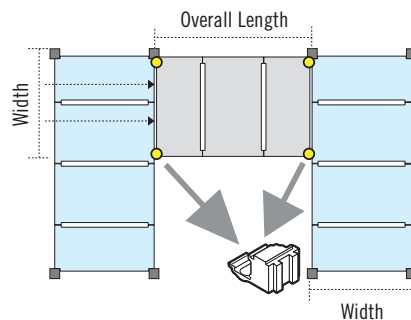

UNIT	CORNER UNIT OVERALL LENGTH	INTERMEDIATE UNIT OVERALL LENGTH
610 mm	590 mm	565 mm
760 mm	740 mm	715 mm
910 mm	890 mm	865 mm
1070 mm	1045 mm	1020 mm
1220 mm	1195 mm	1170 mm

Corner Connectors are recommended for use on traverses 1220 mm or less.

UNIT	STARTER UNIT OVERALL LENGTH	ADD-ON UNIT OVERALL LENGTH	STARTER + ADD-ON UNIT OVERALL LENGTH
610 mm	610 mm	650 mm	1270 mm
760 mm	760 mm	720 mm	1480 mm
910 mm	910 mm	870 mm	1780 mm
1070 mm	1070 mm	1025 mm	2095 mm
1220 mm	1220 mm	1175 mm	2395 mm
1380 mm	1380 mm	1330 mm	2710 mm
1530 mm	1530 mm	1480 mm	3010 mm
1830 mm	1830 mm	1790 mm	3620 mm
1980 mm	1980 mm	1940 mm	3920 mm

Stationary Post Kits

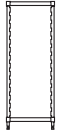

HEIGHT	WIDTH	360 mm	460 mm	540 mm	610 mm
1630 mm	CODE	EPK1464	EPK1864	EPK2164	EPK2464
1830 mm	CODE	EPK1472	EPK1872	EPK2172	EPK2472
2140 mm	CODE	EPK1484	EPK1884	EPK2184	EPK2484

Case Pack: 1 **Color:** Brushed Graphite (580).
Includes 2 stationary posts with leveling feet installed, 1 top post connector, 1 bottom post connector, 8 post connector wedges in a bag and instructions.

Optional Accessories

Dunnage Stands

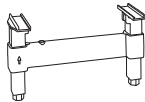

HEIGHT	WIDTH	360 mm	460 mm	540 mm	610 mm
165 mm	CODE	EDS14	EDS18	EDS21	EDS24

Case Pack: 1 **Color:** Brushed Graphite (580).

Accessories

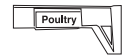
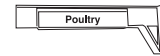
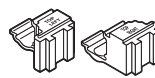
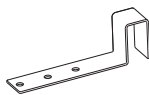

	Seismic Foot	Wall Fastener	90° Left & Right Corner Connectors	ID Tag 150 mm	ID Tag 80 mm
CODE	CSEQ3	CSWF	ECC	CSID	CSID3
COLOR	Silver	Silver	Brushed Graphite (580)	White/Clear	White/Clear
CASE PACK	4 each	4 each	1 set	12 each	12 each



Solid Single Shelf Kits for Stationary Units



New!

WIDTH		LENGTH	610 mm	760 mm	910 mm	1070 mm	1220 mm
360 mm	CODE		ESK1424S	ESK1430S	ESK1436S	ESK1442S	ESK1448S
460 mm	CODE		ESK1824S	ESK1830S	ESK1836S	ESK1842S	ESK1848S
540 mm	CODE		ESK2124S	ESK2130S	ESK2136S	ESK2142S	ESK2148S
610 mm	CODE		ESK2424S	ESK2430S	ESK2436S	ESK2442S	ESK2448S



WIDTH		LENGTH	1380 mm	1530 mm	1830 mm	CAMBRO Exclusive 1980 mm
360 mm	CODE		ESK1454S	ESK1460S	ESK1472S	ESK1478S
460 mm	CODE		ESK1854S	ESK1860S	ESK1872S	ESK1878S
540 mm	CODE		ESK2154S	ESK2160S	ESK2172S	ESK2178S
610 mm	CODE		ESK2454S	ESK2460S	ESK2472S	ESK2478S

SINGLE SHELF - Includes solid shelf plates for 1 shelf, 2 stationary traverses, 1 bag of 8 stationary traverse dovetails (4 each A and B) and instructions.

Case Pack: 1 Color: Brushed Graphite (580).

Vented Single and 4-Shelf Kits for Stationary Units



New!

WIDTH		LENGTH	610 mm	760 mm	910 mm	1070 mm	1220 mm
360 mm A	CODE		ESK1424V	ESK1430V	ESK1436V	ESK1442V	ESK1448V
460 mm A	CODE		ESK1824V	ESK1830V	ESK1836V	ESK1842V	ESK1848V
540 mm A	CODE		ESK2124V	ESK2130V	ESK2136V	ESK2142V	ESK2148V
610 mm A	CODE		ESK2424V	ESK2430V	ESK2436V	ESK2442V	ESK2448V
460 mm B	CODE		—	—	ESK1836V4	—	ESK1848V4
610 mm B	CODE		—	—	ESK2436V4	—	ESK2448V4



WIDTH		LENGTH	1380 mm	1530 mm	1830 mm	CAMBRO Exclusive 1980 mm
360 mm A	CODE		ESK1454V	ESK1460V	ESK1472V	ESK1478V
460 mm A	CODE		ESK1854V	ESK1860V	ESK1872V	ESK1878V
540 mm A	CODE		ESK2154V	ESK2160V	ESK2172V	ESK2178V
610 mm A	CODE		ESK2454V	ESK2460V	ESK2472V	ESK2478V
460 mm B	CODE		—	ESK1860V4	—	—
610 mm B	CODE		—	ESK2460V4	—	—

A - SINGLE SHELF - Includes vented shelf plates for 1 shelf, 2 stationary traverses, 1 bag of 8 stationary traverse dovetails (4 each A and B) and instructions.

B - FOUR SHELVES - Includes vented shelf plates for 4 shelves, 8 stationary traverses, 1 bag of 32 stationary traverse dovetails (16 each A and B) and instructions.

Case Pack: 1 Color: Brushed Graphite (580).

Vented 4-Shelf Stationary Starter Units 460 mm Width

Camshelving®
Elements Series



HEIGHT		LENGTH	910 mm	1070 mm	1220 mm	1380 mm	1530 mm
1630 mm	CODE		ESU183664	ESU184264	ESU184864	ESU185464	ESU186064
1830 mm	CODE		ESU183672	ESU184272	ESU184872	ESU185472	ESU186072

Includes 4 stationary posts with leveling feet installed - pre-assembled with post connectors and wedges, 1 bag of 32 stationary traverse dovetails (16 A and 16 B), vented shelf plates (for 4 shelves), 8 stationary traverses and instructions.
Case Pack: 1 Color: Brushed Graphite (580).

Vented 4-Shelf Stationary Starter Units 540 mm Width



HEIGHT		LENGTH	910 mm	1070 mm	1220 mm	1380 mm	1530 mm
1630 mm	CODE		ESU213664	ESU214264	ESU214864	ESU215464	ESU216064
1830 mm	CODE		ESU213672	ESU214272	ESU214872	ESU215472	ESU216072

Includes 4 stationary posts with leveling feet installed - pre-assembled with post connectors and wedges, 1 bag of 32 stationary traverse dovetails (16 A and 16 B), vented shelf plates (for 4 shelves), 8 stationary traverses and instructions.
Case Pack: 1 Color: Brushed Graphite (580).

Vented 4-Shelf Stationary Starter Units 610 mm Width



HEIGHT		LENGTH	910 mm	1070 mm	1220 mm	1380 mm	1530 mm
1630 mm	CODE		ESU243664	ESU244264	ESU244864	ESU245464	ESU246064
1830 mm	CODE		ESU243672	ESU244272	ESU244872	ESU245472	ESU246072
*2140 mm	CODE		ESU243684PKG	ESU244284PKG	ESU244884PKG	ESU245484PKG	ESU246084PKG

Includes 4 stationary posts with leveling feet installed - pre-assembled with post connectors and wedges, 1 bag of 32 stationary traverse dovetails (16 A and 16 B), vented shelf plates (for 4 shelves), 8 stationary traverses and instructions.
Case Pack: 1 Color: Brushed Graphite (580).

* Due to the size of 2140 mm shelving, starter units ship in 3 cartons.

Vented 4-Shelf Stationary Add-On Units 460 mm Width

Camshelving®
Elements Series



HEIGHT	LENGTH	910 mm	1070 mm	1220 mm	1380 mm	1530 mm
1630 mm	CODE	EA183664	EA184264	EA184864	EA185464	EA186064
1830 mm	CODE	EA183672	EA184272	EA184872	EA185472	EA186072

Includes 2 stationary posts with leveling feet installed - pre-assembled with post connectors and wedges, 1 bag of 32 stationary traverse dovetails (16 A and 16 B), vented shelf plates (for 4 shelves), 8 stationary traverses and instructions.
Case Pack: 1 Color: Brushed Graphite (580).

Vented 4-Shelf Stationary Add-On Units 540 mm Width



HEIGHT	LENGTH	910 mm	1070 mm	1220 mm	1380 mm	1530 mm
1630 mm	CODE	EA213664	EA214264	EA214864	EA215464	EA216064
1830 mm	CODE	EA213672	EA214272	EA214872	EA215472	EA216072

Includes 2 stationary posts with leveling feet installed - pre-assembled with post connectors and wedges, 1 bag of 32 stationary traverse dovetails (16 A and 16 B), vented shelf plates (for 4 shelves), 8 stationary traverses and instructions.
Case Pack: 1 Color: Brushed Graphite (580).

Vented 4-Shelf Stationary Add-On Units 610 mm Width



HEIGHT	LENGTH	910 mm	1070 mm	1220 mm	1380 mm	1530 mm
1630 mm	CODE	EA243664	EA244264	EA244864	EA245464	EA246064
1830 mm	CODE	EA243672	EA244272	EA244872	EA245472	EA246072
*2140 mm	CODE	EA243684PKG	EA244284PKG	EA244884PKG	EA245484PKG	EA246084PKG

Includes 2 stationary posts with leveling feet installed - pre-assembled with post connectors and wedges, 1 bag of 32 stationary traverse dovetails (16 A and 16 B), vented shelf plates (for 4 shelves), 8 stationary traverses and instructions.

Case Pack: 1 Color: Brushed Graphite (580).

* Due to the size of 2140 mm shelving, starter units ship in 2 cartons.

Mobile Post Kits

Camshelving®
Elements Series

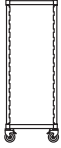

HEIGHT	WIDTH	460 mm	540 mm	610 mm
1778 mm	CODE	EMPK1870	EMPK2170	EMPK2470
1980 mm	CODE	EMPK1878	EMPK2178	EMPK2478

Includes 2 mobile posts without leveling feet installed, 1 top post connector, 1 bottom post connector, 8 post connector wedges in a bag and instructions. Casters are not included and must be ordered separately. **Note:** Height in chart includes casters.
Case Pack: 1 **Color:** Brushed Graphite (580).

Solid Shelf Kits for Mobile Units



WIDTH	LENGTH	910 mm	1070 mm	1220 mm	1380 mm	1530 mm
460 mm	CODE	EMSK1836S	EMSK1842S	EMSK1848S	EMSK1854S	EMSK1860S
540 mm	CODE	EMSK2136S	EMSK2142S	EMSK2148S	EMSK2154S	EMSK2160S
610 mm	CODE	EMSK2436S	EMSK2442S	EMSK2448S	EMSK2454S	EMSK2460S

Includes solid shelf plates for 1 shelf, 2 mobile traverses, 1 bag of 8 mobile traverse dovetails (4 each A and B) and instructions.
Case Pack: 1 **Color:** Brushed Graphite (580).

Vented Shelf Kits for Mobile Units



WIDTH	LENGTH	910 mm	1070 mm	1220 mm	1380 mm	1530 mm
460 mm	CODE	EMSK1836V	EMSK1842V	EMSK1848V	EMSK1854V	EMSK1860V
540 mm	CODE	EMSK2136V	EMSK2142V	EMSK2148V	EMSK2154V	EMSK2160V
610 mm	CODE	EMSK2436V	EMSK2442V	EMSK2448V	EMSK2454V	EMSK2460V

Includes solid shelf plates for 1 shelf, 2 mobile traverses, 1 bag of 8 mobile traverse dovetails (4 each A and B) and instructions.
Case Pack: 1 **Color:** Brushed Graphite (580).

Vented 4-Shelf Mobile Starter Units 460 mm Width

Camshelving®
Elements Series



HEIGHT	LENGTH	910 mm	910 mm	1070 mm	1070 mm	1220 mm	1220 mm
		Premium	Standard	Premium	Standard	Premium	Standard
1778 mm	CODE	EMU183670P	EMU183670	EMU184270P	EMU184270	EMU184870P	EMU184870
1980 mm	CODE	EMU183678P	EMU183678	EMU184278P	EMU184278	EMU184878P	EMU184878

Premium - Includes 4 mobile posts without leveling feet, post connectors and wedges installed, 1 bag of 32 mobile traverse dovetails (16 each A and B), vented shelf plates, 8 mobile traverses, 4 premium casters and instructions.

Standard - Includes 4 mobile posts without leveling feet, post connectors and wedges installed, 1 bag of 32 mobile traverse dovetails (16 each A and B), vented shelf plates, 8 mobile traverses, 4 standard casters and instructions.

Case Pack: 1 **Color:** Brushed Graphite (580).

Vented 4-Shelf Mobile Starter Units 540 mm Width



HEIGHT	LENGTH	910 mm	910 mm	1070 mm	1070 mm	1220 mm	1220 mm
		Premium	Standard	Premium	Standard	Premium	Standard
1778 mm	CODE	EMU213670P	EMU213670	EMU214270P	EMU214270	EMU214870P	EMU214870
1980 mm	CODE	EMU213678P	EMU213678	EMU214278P	EMU214278	EMU214878P	EMU214878

Premium - Includes 4 mobile posts without leveling feet, post connectors and wedges installed, 1 bag of 32 mobile traverse dovetails (16 each A and B), vented shelf plates, 8 mobile traverses, 4 premium casters and instructions.

Standard - Includes 4 mobile posts without leveling feet, post connectors and wedges installed, 1 bag of 32 mobile traverse dovetails (16 each A and B), vented shelf plates, 8 mobile traverses, 4 standard casters and instructions.

Case Pack: 1 **Color:** Brushed Graphite (580).

Vented 4-Shelf Mobile Starter Units 610 mm Width



HEIGHT	LENGTH	910 mm	910 mm	1070 mm	1070 mm	1220 mm	1220 mm
		Premium	Standard	Premium	Standard	Premium	Standard
1778 mm	CODE	EMU243670P	EMU243670	EMU244270P	EMU244270	EMU244870P	EMU244870
1980 mm	CODE	EMU243678P	EMU243678	EMU244278P	EMU244278	EMU244878P	EMU244878





Premium - Includes 4 mobile posts without leveling feet, post connectors and wedges installed, 1 bag of 32 mobile traverse dovetails (16 each A and B), vented shelf plates, 8 mobile traverses, 4 premium casters and instructions.

Standard - Includes 4 mobile posts without leveling feet, post connectors and wedges installed, 1 bag of 32 mobile traverse dovetails (16 each A and B), vented shelf plates, 8 mobile traverses, 4 standard casters and instructions.

Case Pack: 1 **Color:** Brushed Graphite (580).

Casters and Donut Bumper

Camshelving®
Elements Series

					
DIAMETER	127 mm	127 mm	127 mm	127 mm	127 mm
CODE	Premium EMSCBP	Premium EMSCP	Standard EMSCB	Standard EMSC	CSHDDB
DESCRIPTION	Swivel with Brake	Swivel No Brake	Swivel with Brake	Swivel No Brake	Donut Bumper
CASE PACK	2	2	2	2	4

PREMIUM CASTERS - Stainless steel with a non-marking polyurethane wheel. Recommended for use in wet areas or in walk-in refrigerators and freezers.

STANDARD CASTERS - Zinc plated with a non-marking polyurethane wheel. Recommended for use in dry storage areas.

Divider Bar for Elements Series

- Creates a custom storage unit that can accommodate a variety of storage products and sizes on a single unit.
- Divider bars fit on 610 mm wide Elements Series units and hold up to 91 kg per shelf.

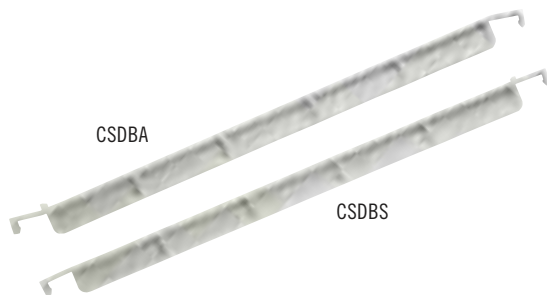

CODE	DESCRIPTION
EDBA	Divider Bar Angled
EDBS	Divider Bar Straight

Case Pack: 4

Color: Speckled Gray (480).

Camshelving® Wall Shelves and Storesafe® Shelf Extenders

Wall Shelves

- Expand storage space in kitchens, above work stations and sinks.
- Features virtually indestructible I-beam supports that hold up to 68 kg per shelf.
- Durable polypropylene withstands temperatures up to 88°C, and will not rust or corrode.
- Snap fit rail design allows shelves to snap on and off for easy cleaning.
- 5 cm backsplash and marine front edge controls spills and cross contamination.

Shelf Extenders

- Convert empty wall space into a functional storage area.
- Use with or without Camshelving Wall Shelves.
- Peg strips withstand temperatures up to 88°C, and will not rust or corrode.

Wall Shelf Color: Speckled Grey (480).

Extender Peg Strip Color: Black (110).

Wall Shelf Kits are covered by the following U.S. Patents D 508,646S & D 512,867 S.



COMPONENT



Shelf Extenders ship in one carton and include:

LENGTH	PEG STRIPS	BRACKETS	HOOKS
91 cm	3	2	6
122 cm	3	3	9

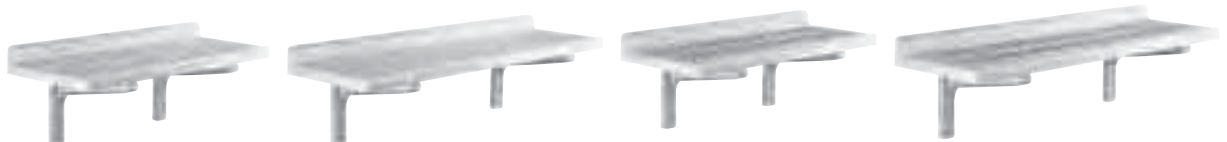

CODE	CSWS1436SK	CSWS1448SK	CSWS1436VK	CSWS1448VK
DESCRIPTION	91 cm Wall Shelf, Solid	122 cm Wall Shelf, Solid	91 cm Wall Shelf, Vented	122 cm Wall Shelf, Vented
EXTERIOR DIMENSIONS	91 L x 36 W x 34 H cm	122 L x 36 W x 34 H cm	91 L x 36 W x 34 H cm	122 L x 36 W x 34 H cm

Case Pack: 1



CODE	CSWS1836SK	CSWS1848SK
DESCRIPTION	91 cm Wall Shelf, Solid	122 cm Wall Shelf, Solid
EXTERIOR DIMENSIONS	91 L x 46 W x 34 H cm	122 L x 46 W x 34 H cm

Case Pack: 1

CODE	CSWS36EK	CSWS48EK
DESCRIPTION	91 cm Shelf Extender	122 cm Shelf Extender
EXTERIOR DIMENSIONS	90 L x 5 W x 39 H cm	121 L x 5 W x 39 H cm

Case Pack: 1

Camshelving®

BASICS SERIES



Smart Design

Uncompromised Reliability

Exceptional Value

Simply Remarkable

*Corner Connector Left (CBCCL), Corner Connector Right (CBCCR), Seismic Foot (CSEQ3), Wall Fastener (CSWF) and Identification Tag (CBID6) are not NSF Listed.



COMPONENT

Camshelving® Basics

SMART DESIGN

- No matter the space in a foodservice operation, whether a walk-in cooler, dry-storage, sanitation or service supplies room, Camshelving Basics is designed with flexibility to fit into any space.
- Post Kits, shelf kits and optional accessories are packaged and sold individually allowing operators to build a shelving configuration to fit their storage needs, even in the most limited spaces.
- Similar to other shelving products by Cambro, shelf plates can be easily removed, washed individually or in sections and placed in an open-end Camrack® and washed in a commercial dishwasher.



UNCOMPROMISED RELIABILITY

- The light-weight, yet extremely durable, non-corrosive, composite material in Camshelving Basics endures even the toughest environments, including hot, cold, dry, wet and humid storage areas and supports all food safety, HACCP and sanitation recommendations.
- Resistant to scratching, peeling, warping and corrosion, every component in Camshelving Basics was rigorously tested for strength, reliability and performance.



EXCEPTIONAL VALUE

- Material easily wipes clean and shelf plates are dishwasher safe thus improving labor efficiency.
- Further reinforcing Cambro's commitment to producing the industry's highest quality and most durable shelving solutions, Basics will feature a lifetime warranty against corrosion eliminating the need for unnecessary replacement costs.



Weight Capacity

	Traverse Length mm	US Self Certification Weight Bearing Capacity		TUV Certification Weight Bearing Capacity	
		PER SHELF	PER UNIT	PER SHELF	PER UNIT
Single Unit (4 shelves)	760-910	272 kg	1089 kg	300 kg	1200 kg
	1070-1220	272 kg	1089 kg	250 kg	1000 kg
	1380-1530	227 kg	907 kg	200 kg	800 kg
Dunnage Stand	1380-1530	363 kg	—		
Corner Unit (4 shelves)	760-1220	136 kg	544 kg		

Shelf plates can be placed in an open end Camrack® OETR314 and washed in a commercial dishwasher.

Dunnage Stands are recommended for units 1380 mm or longer and for corner units of any length. Corner Connectors are recommended for use on traverses 1220 mm or less.

Maximize Space Utilization

Basics is available in post kits & shelf kits for ease of ordering and assembly.

Configurations

Starter Unit

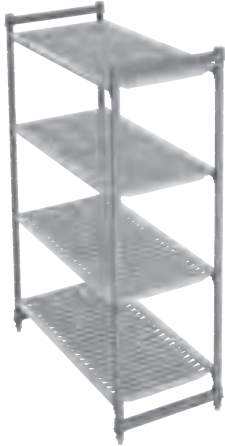

Starter Unit (A)
with Add-on
Unit (B)



Corner Unit



Starter Unit with Add-on Unit
and 4 Corner Connector Sets.

Post Kits

- Ship complete in one box with 2 stationary post with leveling feet installed. Assembly required with post connectors and collar wedges.



Corner Connectors

- Used to build corner and U-Shaped units.
- Easily snap onto traverses.
- Set attaches a starter unit to an add-on unit at a 90° angle or to form a U-shape. Eliminates 1 post kit.
- A set of corner connectors are needed for each shelf.
- Corner connectors are recommended for use on traverses equal to or less than 1220 mm and up to 136 kg per shelf.

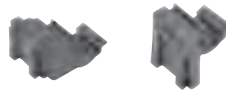

Covered by U.S. Patent D 498,664 S.

Seismic Foot

- Bolts a post to the floor for a more stable base.
- Screws not included.



Wall Fastener

- Fastens a unit to a wall as a safety precaution.
- Screws not included.



Shelf Kits

- Ship complete in one box with two stationary Traverses, eight Dovetails (4 each A and B), Vented Shelf Plates to complete one shelf.



Dunnage Stand

- Increases weight bearing capacity to 363 kg on the bottom shelf only.
- Recommended for units 1380 mm or longer.

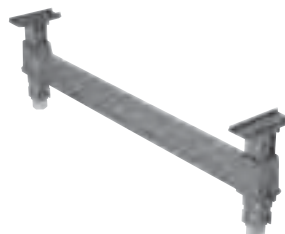

Identification Tag

- Easily clips onto traverses to identify stored items.
- Made of PVC.
- Includes 12 HACCP labels.
- Available in 152 mm only.



Camshelving® Basics Configuration Details

Starter Unit

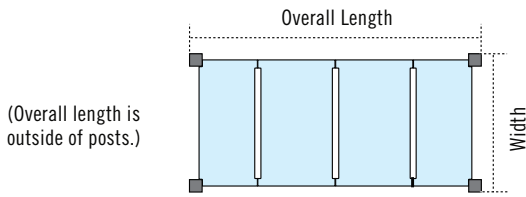

Add-on Unit

Shared posts between starter unit and add-on unit maximizes space.

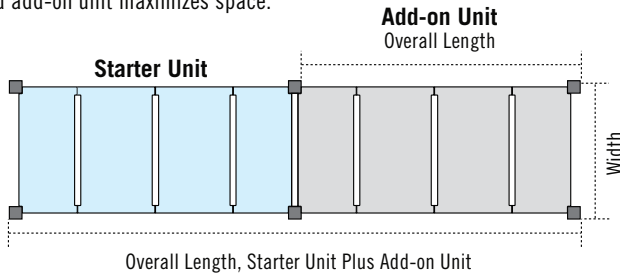

Configuration Lengths

Starter and Add-on Unit

UNIT	STARTER UNIT OVERALL LENGTH	ADD-ON UNIT OVERALL LENGTH	BASIC + ADD-ON UNIT OVERALL LENGTH
760 mm	760 mm	720 mm	1480 mm
910 mm	910 mm	870 mm	1780 mm
1070 mm	1070 mm	1025 mm	2095 mm
1220 mm	1220 mm	1175 mm	2395 mm
1380 mm	1380 mm	1330 mm	2710 mm
1530 mm	1530 mm	1480 mm	3010 mm

Corner Unit

Requires a Starter Unit, Add-on Unit plus one set of Corner Connectors per shelf.

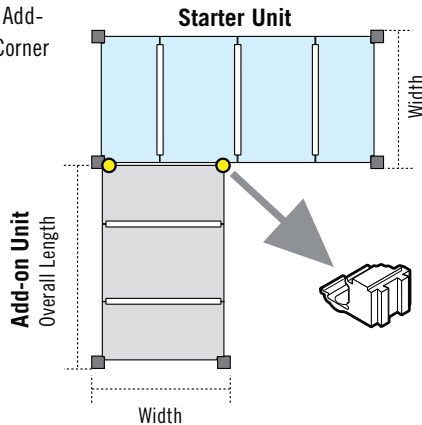

Intermediate Shelf Unit – U-Shaped Unit

Requires two sets of corner connectors per shelf.

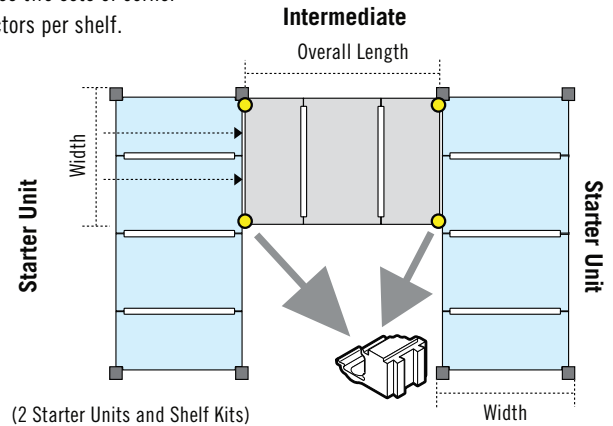

Configuration Lengths

Corner and Intermediate Shelf Unit

UNIT	CORNER UNIT OVERALL LENGTH	INTERMEDIATE SHELF UNIT OVERALL LENGTH
760 mm	740 mm	715 mm
910 mm	890 mm	865 mm
1070 mm	1045 mm	1020 mm
1220 mm	1195 mm	1170 mm

Corner Connectors are recommended for use on traverses 1220 mm or less.

Shelf Spacing

Notches for dovetails are spaced every 100 mm.

POST HEIGHT	NUMBER OF POSITIONS PER POST
Stationary	
1630 mm	14
1830 mm	16
2140 mm	19

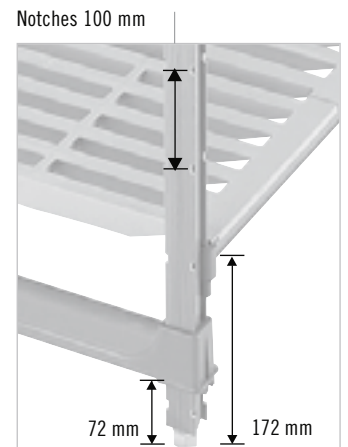

Stationary Post Kits

Includes 2 stationary posts with leveling feet installed, 1 top post connector, 1 bottom post connector, 8 post connector wedges in a bag and instructions. Post kit ships unassembled.

460 mm Width



CODE	DIMENSIONS W x H
CBPK1864	460 x 1630 mm
CBPK1872	460 x 1830 mm
CBPK1884	460 x 2140 mm

Case Pack: 1 **Color:** Brushed Graphite (580).

540 mm Width



CODE	DIMENSIONS W x H
CBPK2164	540 x 1630 mm
CBPK2172	540 x 1830 mm
CBPK2184	540 x 2140 mm

Case Pack: 1 **Color:** Brushed Graphite (580).

610 mm Width



CODE	DIMENSIONS W x H
CBPK2464	610 x 1630 mm
CBPK2472	610 x 1830 mm
CBPK2484	610 x 2140 mm

Case Pack: 1 **Color:** Brushed Graphite (580).

Vented Shelf Kits for Stationary Units

1 SHELF EACH - Includes vented shelf plates for 1 shelf, 2 stationary traverses, 1 bag of 8 stationary traverse dovetails (4 each A and B) and instructions.

460 mm Width

CODE	DIMENSIONS W x H
CBSK1830V	460 x 760 mm
CBSK1836V	460 x 910 mm
CBSK1842V	460 x 1070 mm
CBSK1848V	460 x 1220 mm
CBSK1854V	460 x 1380 mm
CBSK1860V	460 x 1530 mm

Case Pack: 1 **Color:** Brushed Graphite (580).



540 mm Width

CODE	DIMENSIONS W x H
CBSK2130V	540 x 760 mm
CBSK2136V	540 x 910 mm
CBSK2142V	540 x 1070 mm
CBSK2148V	540 x 1220 mm
CBSK2154V	540 x 1380 mm
CBSK2160V	540 x 1530 mm

Case Pack: 1 **Color:** Brushed Graphite (580).



610 mm Width

CODE	DIMENSIONS W x H
CBSK2430V	610 x 760 mm
CBSK2436V	610 x 910 mm
CBSK2442V	610 x 1070 mm
CBSK2448V	610 x 1220 mm
CBSK2454V	610 x 1380 mm
CBSK2460V	610 x 1530 mm

Case Pack: 1 **Color:** Brushed Graphite (580).



Shelving Consulting

Cambro provides a free consulting service to maximize your storage area. No cost or obligation.



- Simply provide the dimensions of the storage space, number of shelves per unit, height of the posts, and any additional requirements you have.
- Cambro will provide a recommended floor plan, 3-D view and product order list in Excel.
- Your Cambro distributor or sales representative will contact you with pricing.
- To contact the Camshelving Consulting Department, please call
CAMBRO USA:
1(714) 230-4113
shelving@cambro.com

Vented 4-Shelf Stationary Starter Units

Includes 4 stationary posts with leveling feet installed - pre-assembled with post connectors and wedges, 4 bags of 8 stationary traverse dovetails (4 A and 4 B), vented shelf plates (for 4 shelves), 8 stationary traverses and instructions.



460 mm Width

CODE	DIMENSIONS W x L x H
CBU183672	460 x 910 x 1830 mm
CBU184272	460 x 1070 x 1830 mm
CBU184872	460 x 1220 x 1830 mm
CBU185472	460 x 1380 x 1830 mm
CBU186072	460 x 1530 x 1830 mm

Case Pack: 1 Color: Brushed Graphite (580).



540 mm Width

CODE	DIMENSIONS W x L x H
CBU213672	540 x 910 x 1830 mm
CBU214272	540 x 1070 x 1830 mm
CBU214872	540 x 1220 x 1830 mm
CBU215472	540 x 1380 x 1830 mm
CBU216072	540 x 1530 x 1830 mm

Case Pack: 1 Color: Brushed Graphite (580).



610 mm Width

CODE	DIMENSIONS W x L x H
CBU243672	610 x 910 x 1830 mm
CBU244272	610 x 1070 x 1830 mm
CBU244872	610 x 1220 x 1830 mm
CBU245472	610 x 1380 x 1830 mm
CBU246072	610 x 1530 x 1830 mm

Case Pack: 1 Color: Brushed Graphite (580).

Vented 4-Shelf Stationary Add-On Unit

Includes 2 stationary posts with leveling feet installed - pre-assembled with post connectors and wedges, 4 bags of 8 stationary traverse dovetails (4 A and 4 B), vented shelf plates (for 4 shelves), 8 stationary traverses and instructions.



460 mm Width

CODE	DIMENSIONS W x L x H
CBA183672	460 x 910 x 1830 mm
CBA184272	460 x 1070 x 1830 mm
CBA184872	460 x 1220 x 1830 mm

Case Pack: 1 Color: Brushed Graphite (580).



540 mm Width

CODE	DIMENSIONS W x L x H
CBA213672	540 x 910 x 1830 mm
CBA214272	540 x 1070 x 1830 mm
CBA214872	540 x 1220 x 1830 mm

Case Pack: 1 Color: Brushed Graphite (580).



610 mm Width

CODE	DIMENSIONS W x L x H
CBA243672	610 x 910 x 1830 mm
CBA244272	610 x 1070 x 1830 mm
CBA244872	610 x 1220 x 1830 mm

Case Pack: 1 Color: Brushed Graphite (580).

Accessories



CSEQ3



CSWF

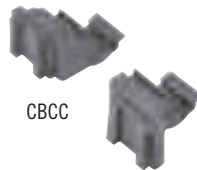

CBCC



CBID6

CODE	DESCRIPTION	CASE PACK
CSEQ3	Seismic Foot	4
CSWF	Wall Fastener	4
CBCC**	Corner Connector Set	1 set
CBID6	ID Tag 152 mm	12

** Color: Brushed Graphite (580). Camshelving® Basics Components are Patent Pending. Corner Connector Left (CBCL), Corner Connector Right (CBCC), Seismic Foot (CSEQ3), Wall Fastener (CSWF) and Identification Tag (CBID6) are not NSF Listed.



Dunnage Stands

CODE	DIMENSIONS
CBDS18	460 mm
CBDS21	540 mm
CBDS24	610 mm

Case Pack: 1 Color: Brushed Graphite (580).

Dunnage Stands are recommended for units 1380 mm or longer.



S-Series Dunnage Racks & Camlink®



S-Series Dunnage Racks

Colors: Dark Brown (131),
Speckled Gray (480).

- Keep frozen, cold or dry inventory 30,5 cm safely off the floor.
- One piece construction and sturdy legs provide strength and stability.
- Heavy duty polypropylene is safe to -38°C, and will not rust, corrode or bend.
- Choose slotted tops for maximum air circulation around perishable products.
- Solid tops catch spills for easy clean up.

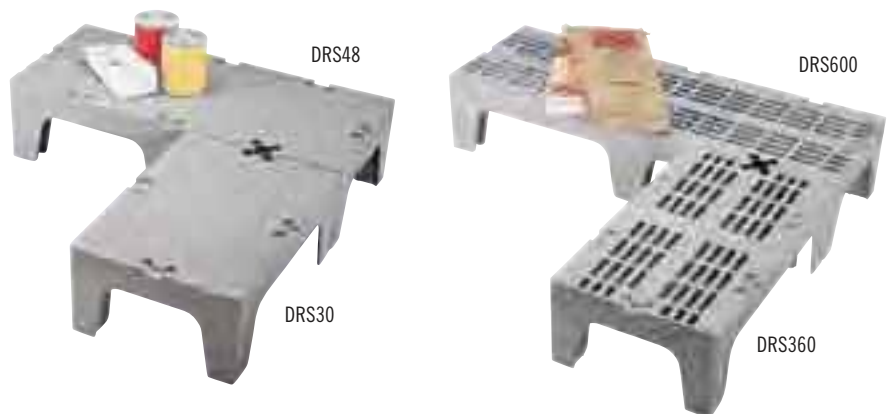

CODE	EXTERIOR DIMENSIONS H x D x W	LOAD CAPACITY
Solid Top		
DRS30	30 x 53,3 x 76 cm	680 kg
DRS36	30 x 53,3 x 91,5 cm	680 kg
DRS48	30 x 53,3 x 122 cm	1,360 kg
DRS60	30 x 53,3 x 152,5 cm	1,360 kg
Slotted Top		
DRS300	30 x 53,3 x 76 cm	680 kg
DRS360	30 x 53,3 x 91,5 cm	680 kg
DRS480	30 x 53,3 x 122 cm	1,360 kg
DRS600	30 x 53,3 x 152,5 cm	1,360 kg

Case Pack: 1

Camlink®

Camlink connectors securely lock dunnage racks together for greater stability.



Color: Black (110).

Camlink is covered by U.S. Patent D 397,289.

Camlink fits all sizes and styles. One free Camlink supplied with every Dunnage Rack.

CODE	CASE PACK
DRLNK	6





CAMBRO
supplies

Food Storage & Preparation / Table Service / Food Presentation / Trays



Food Storage & Preparation



Quick Guide To Storage Solutions

Camwear® Polycarbonate CamSquare® Food Storage Containers

Camwear® Polycarbonate Round Food Storage Containers

Camwear® Polycarbonate Food Storage Boxes

Camwear® Polycarbonate Food Pans

Camwear® Polycarbonate Colander Pans

H-Pans™ High Heat Food Pans

H-Pan™ Colander Pans

Translucent Polypropylene Gastronorm Food Pans

ColdFest® Gastronorm Food Pans, Crocks, Covers & Pumps

StoreSafe® Food Rotation Labels

Pizza Dough Boxes

Ingredient Bins & Camcrisper®

Camwear® Polycarbonate Scoops & Measuring Cups

Quick Guide To Storage Solutions



Storage Containers

CamSquares® Food Storage Containers

Keeps food fresh and maximizes storage areas.



7 SIZES	3 MATERIALS	2 LID TYPES
------------	----------------	----------------

ColdFest®

GN Pans

Holds cold food at safe temperatures without ice for hours.



4 SIZES	1 DEPTH	1 MATERIAL	5 LID TYPES
------------	------------	---------------	----------------

Round Food Storage Containers

Store ingredients or transport ready to serve or partially prepared foods.



8 SIZES	3 MATERIALS	4 LID TYPES
------------	----------------	----------------

Ingredient Bins

Store dry bulk ingredients such as flour and grain.



6 CAPACITIES	1 COLOR	3 LID TYPES
-----------------	------------	----------------

Food Storage Boxes

Safely store bulk produce, meat, poultry and seafood.



2 SIZES	5 DEPTHS	2 MATERIALS	2 LID TYPES
------------	-------------	----------------	----------------



Materials

Camwear® Polycarbonate

Virtually unbreakable polycarbonate material will not crack, bend or dent. Withstands temperatures from -40°C to 99°C.

High Heat H-Pans™

High heat material is safe for use in microwaves, ovens and steam tables. Withstands extreme temperatures from -40°C to 190°C.

Polypropylene

Translucent polypropylene material provides a high chemical resistance. Withstands temperatures from -40°C to 70°C.

Polyethylene

High chemical and impact resistant material. Withstands temperatures from -40°C to 70°C.

ABS

High-performance and impact resistant material. Ideal for temperatures at or below 4°C.



Food Pans

Camwear® Polycarbonate Food Pans

Store, transport and serve all in one pan. Virtually unbreakable polycarbonate will not crack, bend or dent. Withstands temperatures from -40°C to 99°C.



7 SIZES	4 DEPTHS	3 COLORS	7 LID TYPES
------------	-------------	-------------	----------------

High Heat H-Pans™

Pans can go from prep to cooler to oven to steam table. Withstands temperatures from -40°C to 190°C.



7 SIZES	3 DEPTHS	2 COLORS	7 LID TYPES
------------	-------------	-------------	----------------

Food Pan Lids

Covers protect contents better than plastic wrap or foil while saving time and money. Lids improve food safety and extend product freshness. Fit selected Camwear, High Heat and Poly Food Pans.

Flat Cover

Basic cover available in all pan sizes.

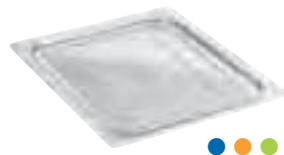

Cover with Handle

Deep molded handle provides secure grip. Available in Black and Clear.



Notched Cover with Handle

Notched cover allows utensils to remain in pan and off of potentially contaminated counters.

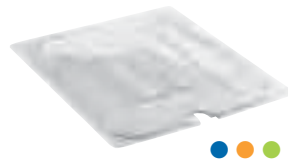

FlipLid®

Keeps contents covered yet flips up easily for service.

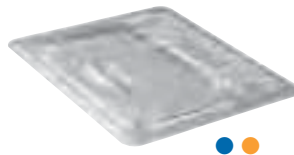

Translucent Food Pans

An economical choice for storage and serving. Ideal for use in cold and ambient environments. Withstands temperatures from -40°C to 70°C.



6 SIZES	2 DEPTHS	1 COLOR	4 LID TYPES
------------	-------------	------------	----------------

Colander Pans

Liquids drain away from food into the pan below for enhanced food quality and improved food safety.



4 SIZES	2 DEPTHS	2 MATERIALS	3 LID TYPES
------------	-------------	----------------	----------------

7 TYPES	7 SIZES	3 MATERIALS	5 COLORS
------------	------------	----------------	-------------

Notched FlipLid

FlipLid with notch to rest spoon in contents with lid closed.

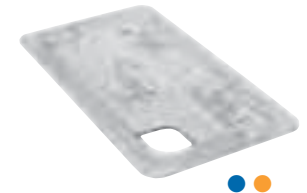

Seal Cover

Economical cover for all pan sizes. Fits Camwear Polycarbonate.



GripLid®

Lid grips the side of the pan, reducing spills and points of cross contamination. Fits Camwear Polycarbonate and High Heat pans.



Seal Cover for Translucent Food Pans

Translucent seal covers provide a tight fit, to protect food quality while eliminating the expense of plastic wrap.

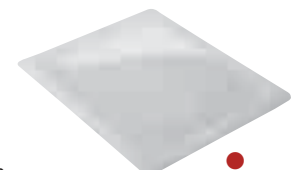

Camwear® Polycarbonate CamSquare® Food Storage Containers



Maximize your storage area with CamSquare food storage containers. The square shape provides 33% better space usage than traditional round containers. Clear polycarbonate provides product visibility for at a glance inventory management. Seal covers feature an inner and outer seal for superior spill resistance, even during transport.

Note: All graduations are approximate.

Dimensions include handles.



Tight fitting Seal Cover is spill resistant, saves expense & safer for employees to handle during transport.

Interstacking saves space when not in use.

Wide molded-in handles ease carrying larger size. Molded-in holes offer quick and sanitary drying.

Stain and odor resistant.

Crystal clear, virtually unbreakable Camwear polycarbonate withstands temperatures from -40°C to 99°C.

Easy to read graduations printed on the outside for quick inventory management.

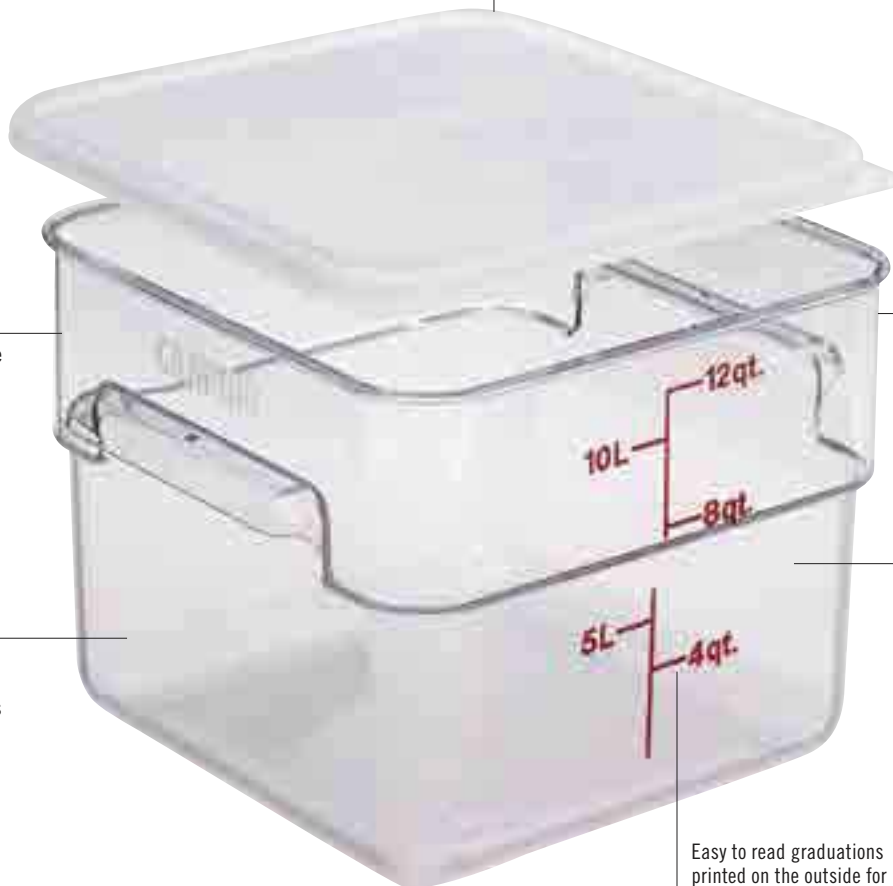

Seal Covers for Camwear Polycarbonate CamSquare*

- Inner and outer seal provide excellent spill resistance.
- Includes a hole on the corner for hanging during storage.
- Translucent lid easily identifies contents.
- Withstands temperatures from -40°C to 70°C.

* Seal covers only fit Camwear Polycarbonate Square Containers.



CamSquare® Translucent Polypropylene & Polyethylene Food Storage Containers

Translucent Polypropylene

Note: All graduations are approximate.



- Translucent material provides some content visibility and high chemical resistance.
- Withstands temperatures from -40°C to 70°C.
- Easy to read graduations are printed on the outside for at a glance inventory management.



Polyethylene

Note: All graduations are approximate.



- Economical storage choice.
- Made of impact, stain and chemical resistant material.
- Withstands temperatures from -40°C to 70°C.



Covers for CamSquares

- Snap-tight polyethylene covers feature thumb tabs for easy removal.
- Poly covers fit Camwear® Polycarbonate, Translucent and Polyethylene CamSquare Containers.



Personalized Storage Products

Personalize food storage products to identify menu items, add fill lines for recipes, or use personalization in multiple languages to help ensure product quality and consistency.



Camwear® Polycarbonate CamSquare® Food Storage Containers



Camwear Polycarbonate



CODE	2SFSCW	4SFSCW	6SFSCW	8SFSCW	12SFSCW**	18SFSCW**	22SFSCW**
CAPACITY	1,9 L	3,8 L	5,7 L	7,6 L	11,4 L	17,2 L	20,8 L
DIM. L x W x H	18,5 x 18,5 x 10 cm	18,5 x 18,5 x 18,7 cm	21,5 x 21,5 x 18,5 cm	21,5 x 21,5 x 23 cm	25,6 x 31 x 21 cm	25,6 x 31 x 32 cm	25,6 x 31 x 40 cm

Case Pack: 6 Color: Clear (135). Height includes covers. ** Dimensions include handles.

Seal Covers for Camwear Polycarbonate CamSquare*



CODE	SFC2SCPP	SFC6SCPP	SFC12SCPP
DESCRIPTION	Fits 1,9 & 3,8 L	Fits 5,7 & 7,6 L	Fits 11,4, 17,2 & 20,8 L

Case Pack: 6 Color: Translucent (190).

Note: All graduations are approximate.

* Seal Covers only fit Camwear Polycarbonate CamSquare containers.

Personalization available on non-food contact areas only. See cresting section for information, ordering and pricing.



2
PRORATED

CamSquare® Translucent Polypropylene & Polyethylene Food Storage Containers



Translucent Polypropylene



CODE	2SFSP	4SFSP	6SFSP	8SFSP	12SFSP**	18SFSP**	22SFSP**
CAPACITY	1,9 L	3,8 L	5,7 L	7,6 L	11,4 L	17,2 L	20,8 L
DIM. L x W x H	18,5 x 18,5 x 10 cm	18,5 x 18,5 x 18,7 cm	21,5 x 21,5 x 18,5 cm	21,5 x 21,5 x 23 cm	25,6 x 31 x 21 cm	25,6 x 31 x 32 cm	25,6 x 31 x 40 cm

Case Pack: 6 Color: Translucent (190). Height includes covers. ** Dimensions include handles.

Polyethylene



CODE	2SFSP	4SFSP	6SFSP	8SFSP	12SFSP**	18SFSP**	22SFSP**
CAPACITY	1,9 L	3,8 L	5,7 L	7,6 L	11,4 L	17,2 L	20,8 L
DIM. L x W x H	18,5 x 18,5 x 10 cm	18,5 x 18,5 x 18,7 cm	21,5 x 21,5 x 18,5 cm	21,5 x 21,5 x 23 cm	25,6 x 31 x 21 cm	25,6 x 31 x 32 cm	25,6 x 31 x 40 cm

Case Pack: 6 Color: Natural White (148). Height includes covers. ** Dimensions include handles.

Covers*



CODE	SFC2	SFC6	SFC12
COLOR	Kelly Green (452)	Winter Rose (451)	Midnight Blue (453)
DESCRIPTION	Fits 1,9 & 3,8 L	Fits 5,7 & 7,6 L	Fits 11,4, 17,2 & 20,8 L

Case Pack: 6

Note: All graduations are approximate.

* Poly Covers fit Camwear®, Translucent and Polyethylene CamSquare Containers.

Personalization available on non-food contact areas only. See cresting section for information, ordering and pricing.



Camwear® Polycarbonate Round Food Storage Containers

Store ingredients or transport ready to serve or partially prepared foods. Clear Camwear polycarbonate allows for easy content identification at a glance. Reduces risk of contamination and enhances food safety. Round shape promotes proper air circulation, ideal for stirring soups and sauces.

Note: All graduations are approximate.

Note: To order Round Food Storage Containers without imprinted graduations, simply add "N" to the end of the code number.

Lids are not interchangeable.



Seal Cover provides excellent spill resistance.

Crystal clear, virtually unbreakable Camwear polycarbonate withstands temperatures from -40°C to 99°C.

Molded-in handles ease carrying. Molded-in holes offer quick and sanitary drying.



Resists food acids, oils & alcohol. Stain and odor resistant.

Interstacking saves space when not in use.

Easy to read graduations on the outside for at a glance inventory management.

Camwear Polycarbonate Covers

- Snap on covers fit tightly.
- Stain resistant to food acids and oils.
- Withstands temperatures from -40°C to 99°C.



Round Seal Covers

- Inner and outer seal provide excellent spill resistance.
- Safe from -40°C to 70°C.
- Thumb tab for easy removal.



Translucent Polypropylene & Polyethylene Round Food Storage Containers

Translucent Polypropylene

- Translucent material offers some product visibility.
- Rounds are durable and resistant to stains.
- Withstands temperatures from -40°C to 70°C.
- Snap on covers fit tightly to protect contents and extend product freshness.

Note: All graduations are approximate.

Note: To order Round Food Storage Containers without imprinted graduations, simply add "N" to the end of the code number.

Lids are not interchangeable.



Polyethylene

- Impact, stain and chemical resistant material.
- An affordable storage choice.
- Safe from -40°C to 70°C.
- Snap on covers fit tightly yet are easily removed.

Note: All graduations are approximate.

Note: To order Round Food Storage Containers without imprinted graduations, simply add "N" to the end of the code number.

Lids are not interchangeable.



Camwear® Polycarbonate Round Storage Containers



Camwear Polycarbonate



CODE	RFSCW1	RFSCW2	RFSCW4	RFSCW6	RFSCW8	RFSCW12	RFSCW18	RFSCW22
CAPACITY	0,9 L	1,9 L	3,8 L	5,7 L	7,6 L	11,4 L	17,2 L	20,8 L
TOP DIAMETER	15,4 cm	20,8 cm	20,8 cm	25,2 cm	25,2 cm	37,8 cm	37,8 cm	37,8 cm
HEIGHT	12,7 cm	11,1 cm	21,8 cm	20,2 cm	27,6 cm	21,3 cm	30,5 cm	38,1 cm
CASE PACK	12	12	12	12	12	6	6	6

Color: Clear (135). Top diameter dimension includes handle. Height dimension includes cover.
Two year warranty on Polycarbonate Rounds.



Camwear Polycarbonate Covers

DESCRIPTION	CASE PACK	CODE
Fits 0,9 L	12	RFSCWC1
Fits 1,9 L & 3,8 L	12	RFSCWC2
Fits 5,7 L & 7,6 L	12	RFSCWC6
Fits 11,4 L, 17,2 L & 20,8 L	6	RFSCWC12

Color: Clear (135).

Seal Covers for Camwear Polycarbonate Rounds

DESCRIPTION	CASE PACK
Fits 0,9 L	12
Fits 1,9 L & 3,8 L	12
Fits 5,7 L & 7,6 L	12
Fits 11,4 L, 17,2 L & 20,8 L	6

Color: Translucent (190).

Translucent Polypropylene & Polyethylene Round Food Storage Containers



Translucent Polypropylene



CODE	RFS1PP	RFS2PP	RFS4PP	RFS6PP	RFS8PP	RFS12PP	RFS18PP	RFS22PP
CAPACITY	0,9 L	1,9 L	3,8 L	5,7 L	7,6 L	11,4 L	17,2 L	20,8 L
TOP DIAMETER	15,4 cm	20,8 cm	20,8 cm	25,2 cm	25,2 cm	37,8 cm	37,8 cm	37,8 cm
HEIGHT	12,7 cm	11,1 cm	21,8 cm	20,2 cm	27,6 cm	21,3 cm	30,5 cm	38,1 cm
CASE PACK	12	12	12	12	12	6	6	6

Color: Translucent (190). Top diameter dimension includes handle. Height dimension includes cover.

Polyethylene



CODE	RFS1	RFS2	RFS4	RFS6	RFS8	RFS12	RFS18	RFS22
CAPACITY	0,9 L	1,9 L	3,8 L	5,7 L	7,6 L	11,4 L	17,2 L	20,8 L
TOP DIAMETER	15,4 cm	20,8 cm	20,8 cm	25,2 cm	25,2 cm	37,8 cm	37,8 cm	37,8 cm
HEIGHT	12,7 cm	11,1 cm	21,8 cm	20,2 cm	27,6 cm	21,3 cm	30,5 cm	38,1 cm
CASE PACK	12	12	12	12	12	6	6	6

Color: Natural White (148). Top diameter dimension includes handle. Height dimension includes cover.

Covers for Translucent Polypropylene Rounds

DESCRIPTION	CASE PACK	CODE
Fits 0,9 L	12	RFSC1PP
Fits 1,9 L & 3,8 L	12	RFSC2PP
Fits 5,7 L & 7,6 L	12	RFSC6PP
Fits 11,4 L, 17,2 L & 20,8 L	6	RFSC12PP

Color: Translucent (190).

Covers for Polyethylene Rounds

DESCRIPTION	CASE PACK	CODE
Fits 0,9 L	12	RFSC1
Fits 1,9 L & 3,8 L	12	RFSC2
Fits 5,7 L & 7,6 L	12	RFSC6
Fits 11,4 L, 17,2 L & 20,8 L	6	RFSC12

Color: Natural White (148).

Camwear® Polycarbonate Food Storage Boxes

Eliminate The Hazard Of Cross Contamination.



Extend the freshness of ingredients and eliminate points of cross contamination by transferring product into food boxes at the receiving dock. A safe solution for storing bulk fruits and vegetables. Clear polycarbonate allows visibility for product identification. Snap tight polycarbonate Camwear covers or SlidingLids™, sold separately, won't come off during transportation.

Camwear and Poly Lids are not interchangeable.

SlidingLids are covered by the following U.S. Patents D 447,906 S & 6,540,098 B1.



Molded-in handles ease carrying.

SlidingLid provides easy access.

Withstands temperatures from -40°C to 99°C for use in coolers and freezers.

Crystal clear, durable Camwear polycarbonate allows for easy product identification.

Smooth surface is easy to clean. Stain and odor resistant.

Texturing on bottom of boxes reduces scratching.

Camwear Polycarbonate Flat Lids

- Snap-tight covers won't come off during transport.
- Top molded-in rails for safer, more secure stacking.
- Durable Camwear polycarbonate is safe from -40°C to 99°C.

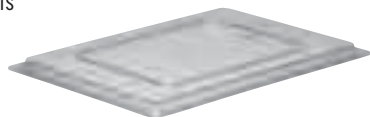

Camwear SlidingLids fits Camwear Food Storage Boxes

- Lid slides back to easily access contents, minimizing handling.
- Reduces the risk of cross contamination since lid remains on food box.
- Made of virtually unbreakable Camwear polycarbonate.



Camwear® Polycarbonate & Polyethylene Food Storage Boxes

Camwear Polycarbonate ColanderKits™

- A complete food safety system packaged in one carton.
- Store raw meats, fish on ice or bulk produce safely.
- Juices and liquids drip into the food box below for quick and easy disposal.
- Reduces handling and risk of cross contamination.



- Kit consists of 1 each of 18269CW food box, 1 each 18268CLRCW colander, and 1 each 1826SCCW sliding lid.



Camwear Polycarbonate Colanders

- Enhances food quality and reduces risk of cross contamination.
- Liquids and juices drain directly into food box for improved food safety.
- Ideal for draining fruits and vegetables, thawing meat or poultry, or storing seafood on ice.



Camwear Polycarbonate Drain Shelves

- Lifts contents out of liquids to enhance food quality and freshness.
- Made of virtually unbreakable polycarbonate.
- Camwear drain shelves fit in both Camwear boxes and white poly boxes.



Polyethylene Food Storage Boxes

- Economical choice for storing bulk produce and ingredients.
- Impact, stain and chemical resistant material.
- Withstands temperatures from -40°C to 70°C.



Camwear Polycarbonate Safety Red and Yellow Food Storage Boxes

- Helps prevent cross-contamination between raw meats, poultry and other food products.
- Red and Translucent yellow color clearly identifies product inside.
- Matching flat cover also available.



Camwear® Polycarbonate Food Storage Boxes



Camwear Polycarbonate

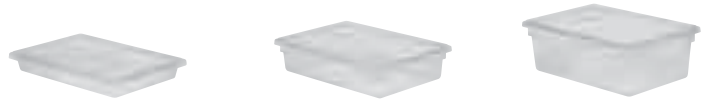

CODE	18263CW	❖● 18266CW	18269CW
DIMENSIONS	46 x 66 x 9 cm	46 x 66 x 15 cm	46 x 66 x 23 cm
APPROX. CAPACITY	18,9 L	33,1 L	49,2 L
CASE PACK	6	6	4

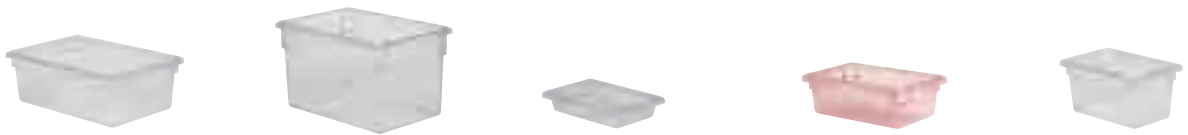

CODE	182612CW	182615CW	12183CW	❖● 12186CW	❖ 12189CW
DIMENSIONS	46 x 66 x 30 cm	46 x 66 x 38 cm	30,5 x 46 x 9 cm	30,5 x 46 x 15 cm	30,5 x 46 x 23 cm
APPROX. CAPACITY	64,4 L	83,3 L	6,6 L	11,4 L	18 L
CASE PACK	4	3	6	6	6

Color: Clear (135). 18266CW & 12186CW available in: ● Safety Red (467), ❖ Safety Yellow (464).

Camwear Polycarbonate Covers



CODE	❖● 1826CCW FLAT LID	1826SCCW SLIDINGLID™	❖● 1218CCW FLAT LID	1218SCCW SLIDINGLID™
DIMENSIONS	45,7 x 66 cm	45,7 x 66 cm	30,5 x 45,7 cm	30,5 x 45,7 cm

Case Pack: 6 Color: Clear (135). 1826CCW & 1218CCW available in: ● Safety Red (467), ❖ Safety Yellow (464).

Polyethylene Food Storage Boxes & Camwear® Polycarbonate Accessories



Polyethylene Boxes



CODE	18263P	18266P	18269P
DIMENSIONS	46 x 66 x 9 cm	46 x 66 x 15 cm	46 x 66 x 23 cm
APPROX. CAPACITY	18,9 L	33,1 L	49,2 L
CASE PACK	6	6	6



CODE	182612P	182615P	12183P	12186P	12189P
DIMENSIONS	46 x 66 x 30 cm	46 x 66 x 38 cm	30,5 x 46 x 9 cm	30,5 x 46 x 15 cm	30,5 x 46 x 23 cm
APPROX. CAPACITY	64,4 L	83,3 L	6,6 L	11,4 L	18 L
CASE PACK	4	3	6	6	6

Color: Natural White (148).

Polyethylene Covers



CODE	1826CP FLAT LID	1218CP FLAT LID
DIMENSIONS	45,7 x 66 cm	30,5 x 45,7 cm

Case Pack: 6 Color: Natural White (148).

Camwear and Poly Lids are not interchangeable.

Accessories

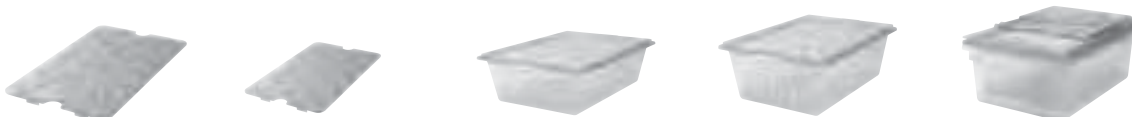

CODE	1826DSCW	1218DSCW	1826CLRCW (12,7 CM DEEP)	18268CLRCW (20 CM DEEP)	18268CLRKIT
DESCRIPTION	Drain Shelf	Drain Shelf	Colander	Colander	ColanderKit™
DIMENSIONS	Fits 46 x 66 cm Food Storage Boxes	Fits 30,5 x 46 cm Food Storage Boxes	Fits Camwear Food Storage Boxes 46 x 66 x 15 cm and deeper	Fits Camwear Food Storage Boxes 46 x 66 x 23 and deeper	One 20 cm Deep Colander One 46 x 66 x 23 cm Food Box One 46 x 66 cm SlidingLid™
CASE PACK	6	6	6	4	1 Kit

Color: Clear (135).

Camwear® Polycarbonate Food Pans

Store, transport and serve all in one pan. Camwear food pans are made from durable polycarbonate that will not crack, bend or dent. Precisely designed to Gastronorm GN specifications, with a bottom to reduce food waste. At half the cost of stainless steel, Camwear polycarbonate pans keep contents as cold as metal pans with less condensation. Pans stack neatly without wedging or sticking.

Camwear Polycarbonate GN pans are not recommended for steam table or microwave use. See H-Pan™ section for these high heat applications.

Colander Pan is covered by U.S. Patent D 528,376 S.

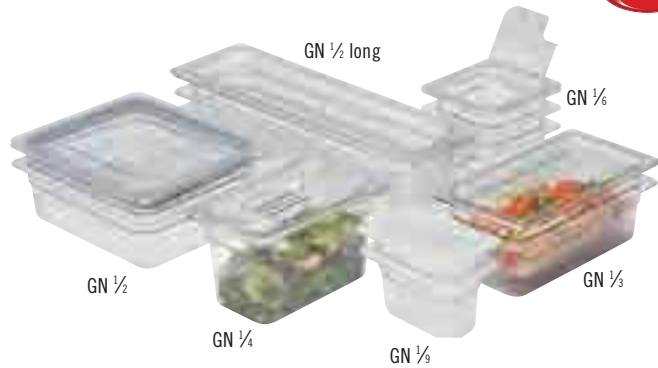

Uniform 1,27 cm flange ensures a smooth fit in prep tables and food bars.

Virtually unbreakable Camwear polycarbonate withstands temperatures from -40°C to 99°C.

Molded-in graduations in standard and metric for easy inventory management.



Won't react with food; minimizes potentially hazardous chemical or acidic reaction.

Non-stick smooth interior surface increases yields and promotes easy cleaning.



Textured bottoms resist scratching.

Cold Test

Tests prove Camwear food pans keep products as cold as stainless steel. Stainless steel may feel colder, but as these test results demonstrate, Camwear food pans keep products just as cold for just as long.

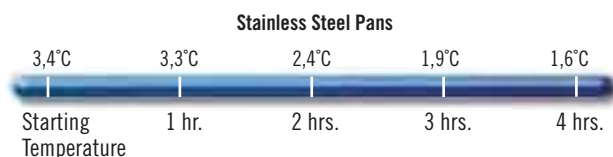
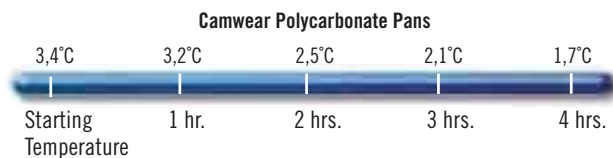
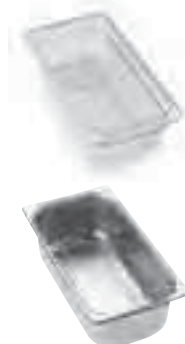

Camwear® Polycarbonate Gastronorm Food Pans Size, & Ordering Information

FULL SIZE

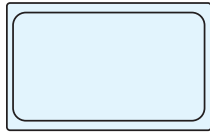

CONFIGURATIONS	PAN CODE	PAN DEPTH	APPROXIMATE CAPACITY
GN 1/1 32,5 x 53 cm	12CW	6,5 cm	8,5 L
	14CW	10 cm	13,0 L
	16CW	15 cm	19,5 L
	18CW	20 cm	25,6 L
	10CWD		Drain Shelf

HALF SIZE LONG

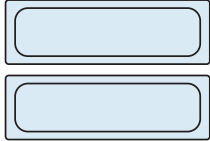

GN 1/2 Long 16,2 x 53 cm	22LPCW	6,5 cm	3 L
	24LPCW	10 cm	5 L
	20LPCWD		Drain Shelf

HALF SIZE

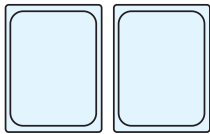

GN 1/2 26,5 x 32,5 cm	22CW	6,5 cm	3,9 L
	24CW	10 cm	5,9 L
	26CW	15 cm	8,9 L
	28CW	20 cm	11,7 L
	20CWD		Drain Shelf

ONE THIRD SIZE

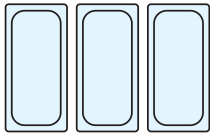

GN 1/3 17,6 x 32,5 cm	32CW	6,5 cm	2,4 L
	34CW	10 cm	3,6 L
	36CW	15 cm	5,3 L
	38CW	20 cm	6,9 L
	30CWD		Drain Shelf

QUARTER SIZE



GN 1/4 16,2 x 26,5 cm	42CW	6,5 cm	1,7 L
	44CW	10 cm	2,5 L
	46CW	15 cm	3,7 L
	40CWD		Drain Shelf

ONE SIXTH SIZE



GN 1/6 16,2 x 17,6 cm	62CW	6,5 cm	1 L
	64CW	10 cm	1,5 L
	66CW	15 cm	2,2 L
	60CWD		Drain Shelf

ONE NINTH SIZE



GN 1/9 10,8 x 17,6 cm	92CW	6,5 cm	0,57 L
	94CW	10 cm	0,85 L
	90CWD		Drain Shelf

Case Pack for all Pans: 6. Lids listed on following page.
See next page for colanders.



Colors: Clear (135), White (148), Black (110). 18CW and 28CW available in Clear (135) only.

Drain Shelf Color: Clear (135).

Colander Color: Clear (135).

.....
All Camwear Polycarbonate GN Food Pans are made of FDA approved materials. All Camwear Polycarbonate GN Food Pans are designed to CEN Gastronorm Standard EN 631-1.
.....

Personalization available on non-food contact areas only. See cresting section for information and ordering.



PRORATED

Drain Shelves

- Support products and promotes drainage.
- Available to fit all pan sizes.

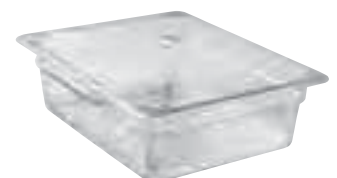
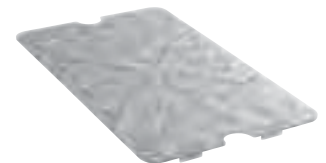

Camwear® Polycarbonate Colander Pans

- Rinse, drain and store all in one pan.
- Liquids drain easily into the food pan below for enhanced food quality and reduced handling.
- Colanders simply lift out of the food pan for safe and quick disposal of liquids.
- Ideal for prepped produce, storing seafood on ice, and defrosting and storing meats and poultry.
- Camwear polycarbonate flat covers, covers with handles and notched covers with handles fit on pans with colanders.

Colander Pans are covered by U.S. Patent D 569,169 S.



13CLRCW



Rinse



Drain



Store

CONFIGURATIONS	PAN CODE	COLANDER DEPTH	FITS CAMWEAR PAN DEPTH*
GN $\frac{1}{4}$ 32,5 x 53 cm	13CLRCW	7,6 cm	10 cm
	15CLRCW	12,7 cm	15 cm
GN $\frac{1}{2}$ 26,5 x 32,5 cm	23CLRCW	7,6 cm	10 cm
	25CLRCW	12,7 cm	15 cm
GN $\frac{2}{3}$ 17,6 x 32,5 cm	33CLRCW	7,6 cm	10 cm
	35CLRCW	12,7 cm	15 cm
GN $\frac{5}{6}$ 16,2 x 17,6 cm	63CLRCW	7,6 cm	10 cm
	65CLRCW	12,7 cm	15 cm

Case Pack for all Pans: 6 Lids listed on following page. * Fits this pan depth & deeper.



Camwear® Polycarbonate Lid Sizes & Ordering Information

Flat Cover

Available in all pan sizes.



FITS PANS	LID CODE	DESCRIPTION
GN $\frac{1}{2}$ 32,5 x 53 cm	10CWC	Flat Cover
	10CWCH	Cover with Handle
	10CWCHN	Notched Cover with Handle
	10CWGL	GripLid
	10PPCWSC	Seal Cover

Cover with Handle

Deep molded handle provides secure grip. Also available in black to help block light, reducing discoloration of meats and cheeses. Helps maintain freshness.



GN $\frac{1}{2}$ Long 16,2 x 53 cm	20LPCWC	Flat Cover
---------------------------------------	---------	------------

GN $\frac{1}{2}$ 26,5 x 32,5 cm	20CWC	Flat Cover
	20CWCH	Cover with Handle
	20CWCHN	Notched Cover with Handle
	20CWL	FlipLid
	20CWLN	Notched FlipLid
	20CWGL	GripLid
	20PPCWSC	Seal Cover

Notched Cover with Handle

Easy access for ladles or spoons.



GN $\frac{2}{3}$ 17,6 x 32,5 cm	30CWC	Flat Cover
	30CWCH	Cover with Handle
	30CWCHN	Notched Cover with Handle
	30CWL	FlipLid
	30CWLN	Notched FlipLid
	30CWGL	GripLid
	30PPCWSC	Seal Cover

Seal Cover

Designed to fit Camwear® polycarbonate Food Pans, our new Translucent Seal Covers feature an inner seal that provides superior spill resistance and maximizes product freshness.



GN $\frac{3}{4}$ 16,2 x 26,5 cm	40CWC	Flat Cover
	40CWCH	Cover with Handle
	40CWCHN	Notched Cover with handle
	40PPCWSC	Seal Cover

FlipLid®

Flip up lid to easily access contents. Food can be held without getting dried out, increasing yields. Reduces points of cross contamination.



GN $\frac{5}{6}$ 16,2 x 17,6 cm	60CWC	Flat Cover
	60CWCH	Cover with Handle
	60CWCHN	Notched Cover with Handle
	60CWL	FlipLid
	60CWLN	Notched FlipLid
	60CWGL	GripLid
	60PPCWSC	Seal Cover

Notched FlipLid

Flip Lid with notch to rest spoon in contents with lid closed.



GN $\frac{5}{6}$ 10,8 x 17,6 cm	90CWC	Flat Cover
	90CWCN	Flat Notched Cover
	90PPCWSC	Seal Cover

Case pack for all lids: 6

GripLid®

Molded-in polyurethane gasket on the lid grips the side of the food pan, reducing spills and points of cross-contamination.



Color: Clear (135).
Seal Cover Color: Sheer Blue (438).
Cover with Handle Colors: Clear (135), Black (110).

Personalization available on non-food contact areas only. See cresting section for information and ordering.

FlipLids are covered by U.S. Patent Des. 420,849,422,838 & 427,012. GripLids are covered by U.S. Patent D 446,076 & Utility Patent 6,273,288 B1.



Gastronorm High Heat H-Pans™

Reduce handling and save expense with one pan that can go from prep to cooler to oven to steam table. H-Pans are designed to Gastronorm GN specifications. Unlike metal pans, H-Pans are safe for use in microwave ovens. Also ideal for heated carts, steam tables and chafing dishes. H-Pans have both standard and metric graduation markings to promote easy inventory management.

Colors: Amber (150), Black (110).

H-Pans are made of FDA approved materials and are designed to CEN Gastronorm Standard EN 631-1. Amber color may vary.

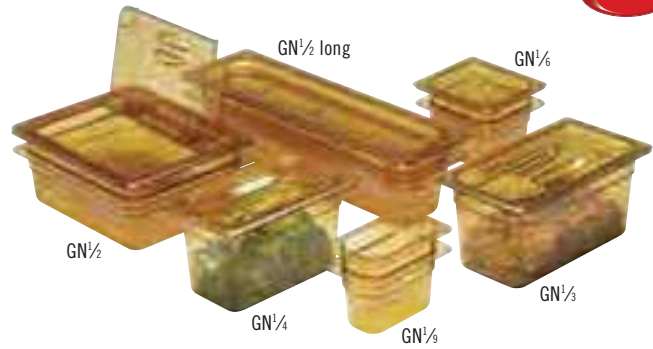

Uniform 1,27 cm flange ensures a smooth fit in prep tables and food bars.

Great for flash freezing, cooking and reheating.

Pans stack neatly, without wedging or sticking.



Non-stick smooth interior surface increases yields and promotes easy cleaning.

Made from FDA approved materials that withstand extreme temperatures from -40°C to 190°C.



Gastronorm High Heat H-Pans™ Sizes & Ordering Information

FULL SIZE

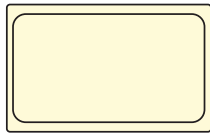

CONFIGURATIONS	PAN CODE	PAN DEPTH	APPROXIMATE CAPACITY
GN $\frac{1}{1}$ 32,5 x 53 cm	12HP	6,5 cm	8,5 L
	14HP	10 cm	13,0 L
	16HP	15 cm	19,5 L
	10HPD	—	Drain Shelf

Colors: Amber (150), Black (110).
Drain Shelf Color: Amber (150).

H-Pans are made of FDA approved materials and are designed to CEN Gastronorm Standard EN 631-1. Amber color may vary.

Personalization available on non-food contact areas only. See crestring section for information and ordering.



HALF SIZE LONG

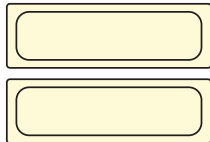

GN $\frac{1}{2}$ Long 16,2 x 53 cm	22LPHP	6,5 cm	3 L
	24LPHP	10 cm	5 L
	20LPHPD	—	Drain Shelf

HALF SIZE

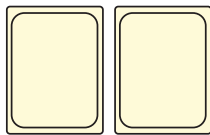

GN $\frac{1}{2}$ 26,5 x 32,5 cm	22HP	6,5 cm	3,9 L
	24HP	10 cm	5,9 L
	26HP	15 cm	8,9 L
	20HPD	—	Drain Shelf



ONE THIRD SIZE

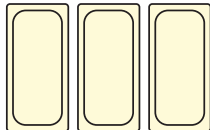

GN $\frac{1}{3}$ 17,6 x 32,5 cm	32HP	6,5 cm	2,4 L
	34HP	10 cm	3,6 L
	36HP	15 cm	5,3 L
	30HPD	—	Drain Shelf

QUARTER SIZE



GN $\frac{1}{4}$ 16,2 x 26,5 cm	42HP	6,5 cm	1,7 L
	44HP	10 cm	2,5 L
	46HP	15 cm	3,7 L
	40HPD	—	Drain Shelf

Drain Shelf

- Supports product and promotes drainage.
- Available to fit all food pan sizes.

ONE SIXTH SIZE



GN $\frac{1}{6}$ 16,2 x 17,6 cm	62HP	6,5 cm	1 L
	64HP	10 cm	1,5 L
	66HP	15 cm	2,2 L
	60HPD	—	Drain Shelf



ONE NINTH SIZE



GN $\frac{1}{9}$ 10,8 x 17,6 cm	92HP	6,5 cm	0,57 L
	94HP	10 cm	0,85 L
	90HPD	—	Drain Shelf

Case Pack: 6 Lids listed on following page.

See next page for colanders.

H-Pan™ Colander Pans

- Colanders drain liquids and grease away from hot foods, improving food quality.
- Ideal for use in microwaves, steam tables and buffet lines.
- Reduces handling and improves food safety.
- H-Pan flat covers, covers with handles and notched covers with handles fit on pans with colanders.



Steam



Hold Hot Foods



Cook & Drain

CONFIGURATIONS	PAN CODE	COLANDER DEPTH	FITS H-PAN DEPTH*
GN $\frac{1}{4}$ 32,5 x 53 cm	13CLRHP	7,6 cm	10 cm
	15CLRHP	12,7 cm	15 cm
GN $\frac{1}{2}$ 26,5 x 32,5 cm	23CLRHP	7,6 cm	10 cm
	25CLRHP	12,7 cm	15 cm
GN $\frac{2}{3}$ 17,6 x 32,5 cm	33CLRHP	7,6 cm	10 cm
	35CLRHP	12,7 cm	15 cm
GN $\frac{5}{6}$ 16,2 x 17,6 cm	63CLRHP	7,6 cm	10 cm
	65CLRHP	12,7 cm	15 cm

Case Pack for all Pans: 6. Lids listed on following page.

* Fits this pan depth & deeper.



H-Pan with Handles

- Full size 6,5 cm deep food pan with handles fits all leading manufacturers' hot holding bins.
- Two handles allow employees to reach the pan from either side of the unit for safe handling.
- Flat Cover, Cover with Handle and Notched Cover with Handle fit on pan.

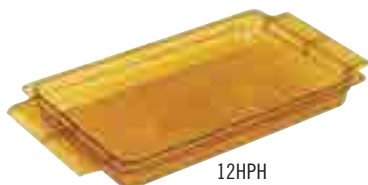

12HPH

CONFIGURATIONS	PAN CODE	PAN DEPTH	APPROXIMATE CAPACITY
GN $\frac{1}{4}$ 32,5 x 53 cm	12HPH*	6,5 cm	8,42 L

Case Pack: 6 Lids listed on following page.

Gastronorm High Heat H-Pan™ Lid Sizes & Ordering Information



Flat Cover

Available in all pan sizes.



FITS PANS	LID CODE	DESCRIPTION
GN $\frac{1}{2}$ 32,5 x 53 cm	10HPC	Flat Cover
	10HPCH	Cover with Handle
	10HPCHN	Notched Cover w/Handle
	10CWGL	GripLid

Cover with Handle

Deep molded handle gives secure grip.

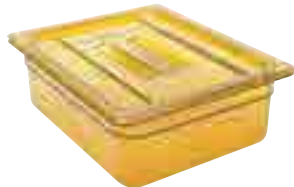

GN $\frac{1}{2}$ Long 16,2 x 53 cm	20LPHPC	Flat Cover
---------------------------------------	---------	------------

GN $\frac{1}{2}$ 26,5 x 32,5 cm	20HPC	Flat Cover
	20HPCH	Cover with Handle
	20HPCHN	Notched Cover w/Handle
	20CWGL	GripLid
	20HPL	FlipLid
	20HPLN	Notched FlipLid

Notched Cover with Handle

Easy access for ladles or spoons.



GN $\frac{2}{3}$ 17,6 x 32,5 cm	30HPC	Flat Cover
	30HPCH	Cover with Handle
	30HPCHN	Notched Cover w/Handle
	30CWGL	GripLid
	30HPL	FlipLid
	30HPLN	Notched FlipLid

FlipLid®

Flip up lid to easily access contents. Food can be held without getting dried out, increasing yields.



GN $\frac{3}{4}$ 16,2 x 26,5 cm	40HPC	Flat Cover
	40HPCH	Cover with Handle
	40HPCHN	Notched Cover w/Handle

GN $\frac{5}{6}$ 16,2 x 17,6 cm	60HPC	Flat Cover
	60HPCH	Cover with Handle
	60HPCHN	Notched Cover w/Handle
	60CWGL	GripLid
	60HPL	FlipLid
	60HPLN	Notched FlipLid

Notched FlipLid®

Flip Lid with notch to rest spoon in contents with lid closed.



GN $\frac{5}{6}$ 10,8 x 17,6 cm	90HPC	Flat Cover
------------------------------------	-------	------------

Case pack for all lids: 6

GripLid®

Molded-in polyurethane gasket on the lid grips the side of the food pan, reducing spills and points of cross-contamination.

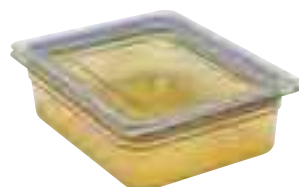

Color: Amber (150).
GripLid Color: Clear (135).
Amber color may vary.

Personalization available on non-food contact areas only. See cresting section for information and ordering.

FlipLids are covered by U.S. Patent D 420,849, D 422,838, D 427,012 & D 6,273,288 B1.



Translucent Polypropylene Gastronorm Food Pans

- An economical choice for storing food.
- Translucent polypropylene material provides content visibility and high chemical resistance.
- Withstands temperature ranges from -40°C to 70°C.
- Non-stick smooth interior surfaces promotes easy cleaning.

Color: Translucent (190).

 Graduation marks and capacities are approximate.

 Full Size (GN $\frac{1}{2}$) Translucent Food Pans are not designed for use in front loading carriers UPC400, UPCS400, UPCH4002, UPC600, UPC800, UPCH8002, UPC1200, UPC1600, UPCH1600. Camtherm® Carts or Combo Carts.

 Translucent Food Pans are made of FDA approved materials.

 Translucent Food Pans interstack with other Cambro Food Pans.

 Personalization available on non-food contact areas only. See cresting section for information, ordering and pricing.

 Translucent Pans are not designed for steam table use.



Ideal for transporting in Cambro top loading carriers.

UPC100	UPCS140	100MPC
UPC140	UPCS160	240MPC
UPC160		



Use Cambro StoreSafe® Food Rotation Labels on Translucent Food Pans to manage inventory and reduce waste.

StoreSafe® ID Clips for GN Food Pans

ID clips color coding system fits both lids and pans, preventing cross contamination through incorrect storage of food products. The color clips make it easy to identify food contents during storage, helping foodservice operators comply with HACCP guidelines. Dishwasher safe. Food Pan ID clips fit Polypropylene GN pans.



CASE CODE	FPID24
DESCRIPTION	case of 24 individual bags of 4 sets of 2 clips in yellow, blue, red, green
CASE PACK	24

* Available for ordering in cases only.
 No broken cartons.

Clip Colors:



Translucent Polypropylene Gastronorm Food Pans And Lids Sizes, & Ordering Information

FULL SIZE

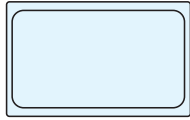

CONFIGURATIONS	PAN CODE	PAN DEPTH	APPROXIMATE CAPACITY
GN $\frac{1}{4}$ 32,5 x 53 cm	14PP	10 cm	13,0 L
	16PP	15 cm	19,5 L
	18PP	20 cm	25,6 L
	10PPD	—	Drain Shelf

HALF SIZE



GN $\frac{1}{2}$ 26,5 x 32,5 cm	24PP	10 cm	5,9 L
	26PP	15 cm	8,9 L
	28PP	20 cm	11,7 L
	20PPD	—	Drain Shelf

ONE THIRD SIZE

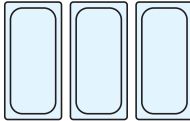

GN $\frac{1}{3}$ 17,6 x 32,5 cm	34PP	10 cm	3,6 L
	36PP	15 cm	5,3 L
	30PPD	—	Drain Shelf

QUARTER SIZE

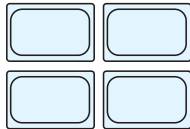

GN $\frac{1}{4}$ 16,2 x 26,5 cm	44PP	10 cm	2,5 L
	46PP	15 cm	3,7 L
	40PPD	—	Drain Shelf

ONE SIXTH SIZE



GN $\frac{1}{6}$ 16,2 x 17,6 cm	64PP	10 cm	1,5 L
	66PP	15 cm	2,2 L
	60PPD	—	Drain Shelf

ONE NINTH SIZE



GN $\frac{1}{9}$ 10,8 x 17,6 cm	94PP	10 cm	0,85 L
	90PPD	—	Drain Shelf

Case Pack: 6

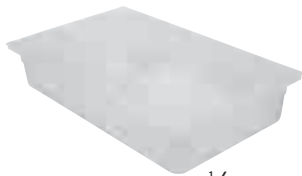

$\frac{1}{1}$

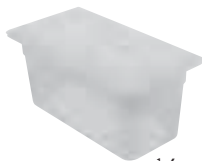

$\frac{1}{2}$

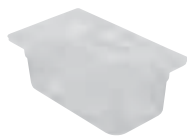

$\frac{1}{3}$

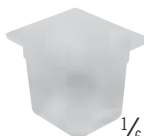

$\frac{1}{4}$

FITS PANS	LID CODE	DESCRIPTION
GN $\frac{1}{4}$ 32,5 x 53 cm	10PPCH	Cover w/ Handle
	10PPSC	Seal Cover
GN $\frac{1}{2}$ 26,5 x 32,5 cm	20PPCH	Cover w/ Handle
	20PPSC	çal Cover
	20PPD	Drain Shelf
GN $\frac{1}{3}$ 17,6 x 32,5 cm	30PPCH	Cover w/ Handle
	30PPCHN	Notched Cover w/ Handle
	30PPSC	Seal Cover
GN $\frac{1}{4}$ 16,2 x 26,5 cm	40PPCH	Cover w/ Handle
	40PPSC	Seal Cover
GN $\frac{1}{6}$ 16,2 x 17,6 cm	60PPCH	Cover w/ Handle
	60PPCHN	Notched Cover w/ Handle
	60PPSC	Seal Cover
GN $\frac{1}{9}$ 10,8 x 17,6 cm	90PPC	Flat Cover
	90PPSC	Seal Cover

Case Pack for all Lids: 6

Color: Translucent (190).

All Translucent Gastronorm Food Pans are made of FDA approved materials.

Personalization available on non-food contact areas only. See cresting section for information, ordering and pricing.

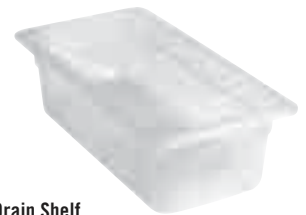

Drain Shelf

Available for all food pan sizes.



Cover with Handle

Available for all food pan sizes. Except for GN $\frac{1}{9}$ size.



Notched Cover with Handle

Available for GN $\frac{1}{3}$ and GN $\frac{1}{6}$ food pans.



Seal Cover

Translucent seal covers protect food quality while eliminating the expense of plastic wrap. Available for all pan sizes.



Flat Cover

Only available for GN $\frac{1}{9}$ food pans.

ColdFest® Gastronorm Food Pans, Crocks, Covers & Pumps



- Keeps contents chilled at or below HACCP guidelines of 4°C without the use of messy ice.
- Freeze for eight hours or overnight before filling with pre-chilled product.
- Half and third-size pans hold contents cold for up to eight hours. Sixth size pans and crocks hold contents cold for up to six hours.
- Conforms to Gastronorm exterior dimensions to fit standard food bars or make tables.
- Stackable to save space when freezing and storing.
- Can be used for direct food contact with all types of food products.

Colors: Black (110), White (148).
Flat Cover Color: Clear (135).
Seal Cover Color: White (148).
Pump with Cover Color: Clear (135).

Suggested holding times are based on tests with ambient room conditions of up to 23°C.

ColdFest is covered under U.S. Patent D 419,364.

* Pumps and round covers not NSF listed.

All ColdFest GN Food Pans are designed to CEN Gastronorm Standard EN 631-1.



Ideal in Cambro Salad bars or to chill condiments and creamers.

Pans / Crock



CODE	26CF	36CF	66CF	CFR18
CONFIGURATIONS	GN½ – 26,5 x 32,5 cm	GN½ – 17,6 x 32,5 cm	GN½ – 16,2 x 17,6 cm	ø 17,3 cm
DEPTH	15 cm	15 cm	15 cm	17 cm
APPROX. CAPACITY	6 L	3,5 L	1,4 L	1,6 L

Case Pack: 1



ColdFest Food Pans are made with high-impact resistant ABS shells and non-toxic refrigerant gel cores.

Covers



CODE	20CFC	30CFC	60CFC	CFRC18*	CFRSC18
DESCRIPTION	Flat Cover	Flat Cover	Flat Cover	Flat Cover	Seal Cover
FITS COLDVEST	GN½	GN⅓	GN⅙	Crock	Crock

Case Pack: 2

Pumps with Covers



CODE	CFPSRC10*	CFPMRC10*	CFPFR10*
DESCRIPTION	Standard Pump dispense 29,5 mL portions	Maxi Pump for chunky condiments	Fixed Nozzle Pump for controlled dispensing
DIMENSIONS W x D x H	18,4 x 22,8 x 28,5 cm	18,4 x 26 x 31,4 cm	18,4 x 29,5 x 29,8 cm

Case Pack: 1



StoreSafe® Food Rotation Labels

- Label and adhesive dissolve in less than 30 seconds.
- Run under hot or cold water or through the dishwasher.
- Safe for all sewer and septic systems and will not build up in drains.
- Withstands freezing temperatures as low as -40°C.
- Withstands high heat temperatures up to 93°C for 4 hours.
- Microwave safe.
- Leaves behind no sticky residue which can be a breeding ground for bacteria.
- Assists in a proper First In First Out (FIFO) food storage system.
- 100% dissolvable and biodegradable.

Label color: White (148).

* Available for ordering in cases only. No broken cartons.

100% biodegradable. FDA approved material.



Eliminates sticky residue and prevents cross contamination! No more scraping!



Dissolves completely off all containers when placed through dishwasher or under running water.



Retail Blister Pack

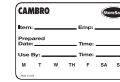

CASE CODE	23SL
LABEL SIZE	5 x 7,6 cm
CASE PACK	20 rolls, 100 labels per roll

StoreSafe Label Blister Pack is covered by U.S. Patent 690,589 S.

Bulk Dispenser Pack – Half Size Labels



CASE CODE	1252SLB250	1252SLINB250
LABEL SIZE	3 x 5 cm	3 x 5 cm
CASE PACK	24 rolls, 250 labels per roll	24 rolls, 250 labels per roll

Bulk Dispenser Pack

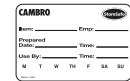

CASE CODE	23SLB250	23SLB6250
LABEL SIZE	5 x 7,6 cm	5 x 7,6 cm
CASE PACK	24 rolls, 250 labels per roll	6 rolls, 250 labels per roll

Bulk Dispenser Pack – Blank Labels



CASE CODE	23SLINB250
LABEL SIZE	5 x 7,6 cm
CASE PACK	24 rolls, 250 labels per roll

Laser Sheet



BOX CODE	SLL30 (Avery® 5160)
LABEL SIZE	2,54 x 6,35 cm
CASE PACK	100 sheets, 30 labels per sheet 21,6 x 27,9 cm sheet size

Pizza Dough Boxes



DB18263P

Polypropylene

- Ideal for storing, transporting, proofing and cooling dough.
- Lightweight, durable, and break resistant.
- Chemical resistant won't absorb odors and is easy to clean.
- Boxes nest tightly together to keep out dirt and contaminants, extending product freshness.

- The previous box acts as a tight lid for the box below, reducing the need and expense of covers.
- Withstands temperatures from -40°C to 70°C.
- Cover can be used as an 46 cm x 66 cm tray.

Color: White (148).

Polycarbonate & Polypropylene dough boxes do not inter stack

CD1826PDB Color: Coffee Beige (157), Brown(131), Black (110), Slate Blue (401), Grey (180).

* Polypropylene dough boxes are safe for use in high temperature dishwashers.

Caster Type A: 12,7 cm Casters: 2 fixed, 2 swivel, 1 with brake.



CD1826PDB

Capacity: 136 kg
Caster Type: A

Holds: DB18263CW, DB18266CW, DB18263P



Camwear® Polycarbonate

- Prevents crusting to increase the storage life of dough.
- Virtually unbreakable polycarbonate construction is reinforced on all sides.
- Boxes won't bend or lose their shape.

- Withstands temperatures from -40°C to 99°C.
- Available in 7,62 cm and 15,24 cm depths.



DB18266CW

DB18263CW

www.cambro.com

CODE	OUTSIDE DIMENSIONS	INSIDE DIMENSIONS
Polypropylene Pizza Dough Box		
DB18263P	46 x 66 x 7,6 cm	40,6 x 60,9 cm
Polypropylene Cover		
DBC1826P	46 x 66 cm	—
Camwear Polycarbonate Pizza Dough Boxes		
DB18263CW	46 x 66 x 7,6 cm	40,6 x 60,9 cm
DB18266CW	46 x 66 x 15,3 cm	40,6 x 60,9 cm
Camwear Polycarbonate Cover		
DBC1826CW	46 x 66 cm	—
Case Pack: 6 Color: White (148).		
Camdolly® For Pizza Dough Boxes		
CD1826PDB**	50,5 x 71 x 26 cm	44,5 x 64, cm
Case Pack: 1 **Optional Strap Available.		

Ingredient Bins & Camcrisper®

Ingredient Bins

- Store bulk dry ingredients such as flour and grain.
- Hygienic clear sliding lid reduces handling and allows for quick content identification.
- Bin made of FDA-accepted material so no liners are needed.
- Designed to fit under standard work tables.

Camcrisper

- A self-contained system for storing, washing and transporting bulk produce.
- Prevents cross contamination and minimizes unnecessary handling.
- Transfer dry produce out of cartons into bin, cover and roll into cooler for safe storage.
- Wash and rinse produce for easy and safe prep.

7,6 cm Casters: 2 fixed, 2 swivel.

Color: White (148).

Scoops sold separately. S-Hook included.



Casters feature wide wheels for excellent stability and weight bearing capability.



Now with Sliding Lid.

CODE	IBS20	IBS27	IBS37	IBSF27
DIMENSIONS W x L x H	33 x 75 x 71 cm	42 x 75 x 71 cm	55 x 75 x 71 cm	33 x 76,5 x 72,5 cm
CAPACITY	81 L	102 L	140 L	102 L
CUBIC METER	0,081	0,102	0,140	0,101
LOAD CAPACITY (SUGAR)	77 kg	103 kg	143 kg	98 kg
LOAD CAPACITY (FLOUR)	63 kg	68 kg	102 kg	68 kg

Case Pack: 1



CODE	IB32	IB36	IB44	CC32 (Camcrisper)
DIMENSIONS W x L x H	56 x 61 x 58,5 cm	39 x 75 x 74 cm	47 x 75 x 74 cm	56 x 61 x 58,5
CAPACITY	121 L	129 L	161 L	121 L
CUBIC METER	0,123	0,134	0,160	0,123
LOAD CAPACITY (SUGAR)	98 kg	114 kg	145 kg	24 lettuce heads (unfinished)
LOAD CAPACITY (FLOUR)	73 kg	82 kg	104 kg	42 lettuce heads (finished)

Case Pack: 1

Camwear® Polycarbonate Scoops & Measuring Cups

Camwear Polycarbonate Scoops

- Virtually unbreakable Camwear polycarbonate will not dent, chip or rust.
- Molded-in sure grip handle includes a hole for hanging.
- Ideal for use with Cambro Ice Caddies and Ingredient Bins.

Color: Clear (135).

Personalization not available.



CODE	APPROXIMATE CAPACITY	CASE PACK
SCP6CW	170 g	12
SCP12CW	340 g	12
SCP24CW	680 g	12
SCP64CW	1814 g	6

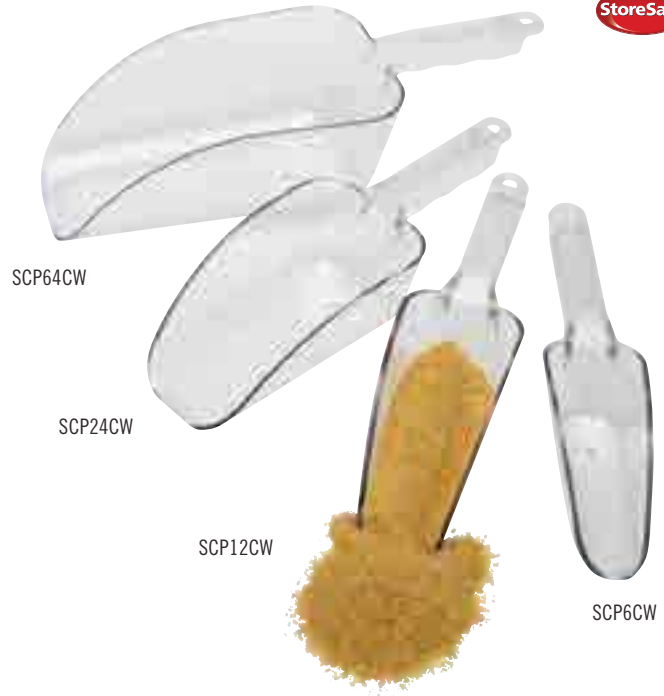

Camwear Polycarbonate Measuring Cups

- Externally marked graduations are molded in and imprinted in red for American standard and blue for metric for easy measurement.
- Durable, virtually unbreakable Camwear polycarbonate will not dent, ensuring an accurate measurement every time.
- Molded-in handle will not break off.

Color: Clear (135).

Personalization available on non-food contact areas only. See cresting section for information and ordering.



CODE	CAPACITY	CASE PACK
25MCCW	225 mL (dry measure)	12
50MCCW	0,5 L	12
100MCCW	1 L	12
200MCCW	2 L	12
400MCCW	4 L	1



Graduations are molded-in and imprinted in Blue for metric and Red for standard American measurements.



Table Service



Camwear® Polycarbonate Dinnerware

Versa Camcovers®

Camwear Polycarbonate Camcovers

Promote Your Brand

Camwear Polycarbonate Pitchers

Aliso® Barware, Goblets and Dessert Glass

CamLid®

Camwear® Polycarbonate Huntington®

& SAN Newport® Tumblers

SAN Laguna® & Del Mar® Tumblers

SAN Colorware Tumblers

Camwear® Polycarbonate Tumblers & Camlitters®

Beverage Dispenser, Pail With Bail & Swirl Bowls®

Camwear® Polycarbonate Wine Buckets,

Punch Bowls & Bud Vase

Camwear® Polycarbonate Dinnerware

5 5 YEAR PRORATED
GUARANTEE AGAINST
BREAKAGE

- Virtually unbreakable Camwear polycarbonate resists stains, odors and scratches.
- Textured surface on salad and dinner plates for long wear.
- Ideal for schools, cafeterias, day care centers and healthcare facilities.



Oval Platters & Compartment Plates



CODE	90SPCW	120CWP	93CW	HK93BCW
DIAMETER	22,9 x (H) 4 cm	30,5 x 22,9 cm	22,9 cm	24,1 cm
DESCRIPTION	Round, Soup Bowl	Oval, Narrow Rim	Narrow Rim	Narrow Rim
CASE PACK	48	24	48	12

*HK93BCW is available in Beige only (133)

Plates



CODE	10CWNR	9CWNR	825CWNR	725CWNR	65CWNR	55CWNR
DIAMETER	25,4 cm	22,9 cm	21 cm	18,4 cm	16,5 cm	14 cm
DESCRIPTION	Narrow Rim	Narrow Rim	Narrow Rim	Narrow Rim	Narrow Rim	Narrow Rim
CASE PACK	48	48	48	48	48	48

Bowls



CODE	10CW	10CWL	35CW	45CW	50CW	60CW	100CW	150CW
APPROX. CAPACITY	278 mL	—	252 mL	150 mL	452 mL	322 mL	370 mL	494 mL
DESCRIPTION	Square Bowl	Lid for 10CW Bowl	Bouillon	Fruit Cup	Nappie Bowl	Grapefruit Bowl	Nappie Bowl	Square Bowl
CASE PACK	48	48	48	48	48	48	48	48
SHAPE	Square	Square	Round	Round	Round	Round	Round	Top/Round Bottom/Square
OUTSIDE DIAMETER	10,2 x 10,2 cm	—	9,8 cm	11,7 cm	13,3 cm	15,2 cm	12,5 cm	Top: 13,3 cm Bottom: 6,4 x 6,4 cm
HEIGHT	4,8 cm	—	5,4 cm	3,3 cm	5,4 cm	4 cm	24,3 cm	5,7 cm

Mug & Cup



CODE	75CW	96CW
APPROX. CAPACITY	239 mL	288 mL
DESCRIPTION	Stacking Cup	Mug
CASE PACK	48	48
MAX DIA./HEIGHT	10,3* cm / 8 cm	10,6* cm / 9,5 cm
FULL SIZE CAMRACK®	16C414	16C414

* Maximum diameter includes handles.

Heat Keepers



DESCRIPTION	3 COMPARTMENT BASE AND COVER	HEAT KEEPER BASE AND COVER FOR 22,9 CM PLATE
CASE PACK	6	6

HK93CW is available in Beige (133).
HK39 is available in Antique White (148).

Camcarrier® for HK93CW available by special request. Call Cambro Customer Service for more information.

Versa Camcovers®

Serve hot food hot with the Versa Camcover, an elegant and efficient alternative to traditional metal covers.

- Withstands temperatures up to 149°C.
- Covers remain cool to the touch for easy handling.
- Lighter and quieter than metal covers.
- Elegant appearance without polishing.
- Keeps food warm longer than metal covers.
- Microwave safe.

Refer to the Cambro Camcover handbook on our website to determine what size Versa Camcover is best for your plates. Or, send one of your plates to Cambro Customer Service for sizing.

Colors: Ivory (380), Granite Grey (191), Antique Parchment (101).



CODE	INSIDE DIAMETER	OUTSIDE HEIGHT
Square		
1111SQVS	20,26 cm	7,3 cm
1212SQVS	30,80 cm	7,0 cm
99SMVS	23,2 cm	6,67 cm
1111SMVS	20,26 cm	7,0 cm
85SFVS	20,91 cm	7,0 cm
978SFVS	25,4 cm	7,0 cm
Round		
68VS	16,5 cm	5,6 cm
86VS	21,0 cm	6,7 cm
91VS	23,2 cm	6,8 cm
913VS	24,9 cm	6,8 cm
95VS	23,7 cm	6,8 cm
99VS	24,3 cm	6,7 cm
911VS	24,6 cm	7,0 cm
100VS	25,4 cm	6,8 cm
103VS	25,9 cm	6,8 cm
105VS	26,2 cm	6,8 cm
106VS	26,4 cm	7,2 cm
1010VS	27,0 cm	6,8 cm
1012VS	27,3 cm	6,8 cm
1014VS	27,6 cm	6,8 cm
116VS	28,9 cm	8,1 cm
120VS	30,5 cm	7,3 cm
124VS	31,1 cm	7,3 cm

Case Pack: 12

Square Plate Camcovers

- Square shape fits popular square plate designs.
- Secure stacking for improved server safety; the foot of the plate nests securely on the top of the cover below.
- Elegant appearance with less noise during service.



1111SQVS Fits 27,9 cm Syracuse Quadra Plate



85SFVS Fits 21,6 cm Oneida Sant' Andrea Fusion Plate



99SMVS Fits 22,9 cm Steelite Metro/Quadro Plates

1111SMVS Fits 27,9 cm Steelite Metro/Quadro Plates



Microwave safe!



Perfect for heated carts!

Camwear® Polycarbonate Camcovers®

Camwear Polycarbonate Camcovers

- Food stays hot and appetizing without re-heating.
- Ideal for use in heated carts.
- Safe up to 99°C.
- Virtually unbreakable polycarbonate will not dent or scratch.
- Lightweight for quiet service.
- Saves on labor with no polishing required.

Colors: Clear (152), Amber (153), Beige (133), Silver (486).

For help selecting the correct size plate cover, refer to the Camcover Sizing Guide on our website at www.cambro.com. Or, send one of your plates to Cambro Customer Service for sizing.

Personalization available. See crestring section for information and ordering.



CODE	INSIDE DIAMETER	OUTSIDE HEIGHT	CASE PACK
806CW	21,4 cm	6,8 cm	12
900CW	23,2 cm	7,0 cm	12
901CW	23,7 cm	7,2 cm	12
905CW	24,1 cm	7,2 cm	12
909CW	24,8 cm	7,0 cm	12
9011CW	25,4 cm	7,3 cm	12
9013CW	25,4 cm	7,0 cm	12
1000CW	25,9 cm	6,8 cm	12
1005CW	26,8 cm	7,2 cm	12
1007CW	27,0 cm	7,0 cm	12
1013CW	27,5 cm	6,8 cm	12
1101CW	27,9 cm	6,8 cm	12
1202CW	30,8 cm	7,0 cm	12

Promote Your Brand

Personalize tumblers, barware, pitchers or other table service items with your logo or design. Use personalized drinkware in promotions.

Food storage products can also be personalized to identify menu items, add fill lines for recipes or to add instructions in multiple languages to help ensure product quality and consistency.



Look for this icon that identifies items that can be personalized.

IMPRINTING TABLE SERVICE AND STORAGE ITEMS

Minimum Quantity: 6 Cases

Sample Turnaround Time: 7-10 business days after receipt of approved artwork

Print Area: 6 mm to 10 cm, subject to printable area on each item

PERSONALIZATION CHARGES (NET)

Sample Charge: *** (Charge will be billed on sample order, credited on first purchase order)

Plate Charge: *** (Billed on sample order, one time charge)

Set-Up Charge: *** (Per order)

Cost Per Imprint: *** per side

HOW TO ORDER A SAMPLE

1. Request a Sample

Contact your local Cambro representative to complete and submit your sample request to Cambro.

2. Provide Artwork

Provide ready to use artwork, digital format only. Completed sample request form must be submitted to Cambro **PRIOR** to artwork being sent. If artwork is incomplete, graphic support services are available at *** per hour.

3. Submit Artwork

E-mail artwork to your Cambro Rep or direct to Cambro at letsgetpersonal@cambro.com. Title e-mail subject with logo name and provide contact info.

File dimensions: 100% reproduction size, 300dpi resolution.

File type:

Adobe® Illustrator®, Photoshop®.

File format: jpeg, tiff, and eps.

Or mail digital artwork to:

Cambro Manufacturing Company.

Attn: Kristie Patterson, 7601 Clay Avenue, Huntington Beach, CA 92648.

4. Questions regarding artwork?

Tel: (49)7022-90-100-0;

Ireland Tel: 1800 509 046;

for UK Tel: 0800 587 0057 or

Fax: (49)7022-90-100-19.

5. Sample Approval

A signed sample approval form must be faxed to Cambro customer service prior to processing any purchase orders. This form is included with each sample.

*** Contact your Cambro representative for pricing.



CHOOSE ANY ONE OF THESE STANDARD IMPRINT COLORS

Due to the catalog printing process, the colors shown may not be exact.



Red



Yellow



Light Blue



Dark Blue



Green



Orange



Violet



Black



White



Grey



Gold



Silver

Camwear® Polycarbonate Pitchers

- Made of virtually unbreakable Camwear polycarbonate.
- Lightweight for easy handling.
- Exclusive ice-control contoured lip and pour spout reduce spills.
- Slotted base allows for complete and sanitary drying.

Color: Clear (135). P600CW is also available in Amber (153).

Capacities calculated to rim.

Personalization available. See cresting section for information, ordering and pricing.

PC34CW Stackable Pitcher is covered by the following U.S. Patent D 682,002 S.



P600CW, P480CW and P320CW
An industry standard. Broad base for stability, prevents tipping.

PL60CW
Laguna® Pitcher has a hammered texture that hides scratches. Design matches the Laguna Tumbler. Pour liquids from front or ice and liquid from sides.



CODE	P320CW	P480CW	P600CW	P60CW	PL60CW
CAPACITY	0,95 L	1,4 L	1,8 L	1,8 L	1,8 L
HEIGHT WITH SPOUT (CM)	17	20	20,5	23	20
DIAMETER WITH HANDLE (CM)	14,5	16	17	18,5	17

Case Pack: 6

PE600CW
Economy polycarbonate pitcher. Lightweight design. Pour liquids from front or ice and liquid from sides.

P64CW
Tapered design and drip-proof spout.

PC64CW
Three position lid can strain ice, free pour or close to protect contents.

PC34CW
Stackable Pitcher and Lid with a frosted design to hide scratches.*

P34CW
Stackable Pitcher only.
P34LCW
Stackable Pitcher Lid only.

*Three position lid can strain ice, free pour or close to protect contents.



CODE	PE600CW	P64CW	PC64CW	PC34CW	P34CW	P34LCW
CAPACITY	1,8 L	1,9 L	1,9 L	1 L	1 L	—
HEIGHT WITH SPOUT (CM)	20	23,5	24,8 with lid	19,05 with lid	16,8	5,11
DIAMETER WITH HANDLE (CM)	18,7	18,5	18,5	17	17	11,4

Case Pack: 6

Camwear® Polycarbonate Aliso® Barware, Goblets and Dessert Glass

Aliso Barware replicates the look, heft and clarity of glass with shatterproof polycarbonate. The smooth seamless appearance makes Aliso Barware a stylish choice for casual dining, outdoor events or for poolside service.

- Barware items have large, heavy bases for stability.
- Bases designed for fast draining and complete drying.
- Chill or frost barware without concerns of thermal shock damage.

Color: Clear (135).

Capacities calculated to rim.

Personalization available. See crestring section for information, ordering and pricing.



CODE	BWM10CW	BWW10CW	BWP14CW	BWB16CW	GB850CW	GB1200CW	DG3CW*
DESCRIPTION	Martini	Wine	Pilsner	Beer Mug	Goblet	Goblet	Dessert Glass
MAX DIAMETER	12,2 cm	7,5 cm	8,3 cm	12,1 cm	7 cm	7 cm	5,8 cm
MAX HEIGHT	17,5 cm	17,1 cm	24,3 cm	15,9 cm	15,9 cm	19,4 cm	7,7 cm
FULL SIZE CAMRACK®	9S638	25S638	25S958	16S638	36S534	36S738	49S318
CAPACITY TO RIM	310,5 mL	310,5 mL	458,4 mL	473 mL	266 mL	378 mL	100 mL
CASE PACK	12	24	24	12	24	24	72

*Available for ordering in cases only. No broken cartons.

Cambro® Tumblers

Cambro tumblers feature the look and feel of glass, but offer the cost savings and lightweight handling of break resistant plastic. These tumblers weigh up to 50% less than glass, making it easier and safer for wait staff to carry and serve beverages. Our tumblers cost about 33% less than comparable glassware. Less breakage means

lower replacement costs and less staff time spent cleaning up broken glass. All of our tumblers feature stacking lugs for easy stacking, transport and storage and are dishwasher safe.

Expand your service options! Valued by restaurants, hospitals and schools, Cambro tumblers are ideal anywhere you want the upscale

look of glass without the worry of breakage. Our elegant designs are ideal for outdoor catering and resort use. Whatever your need, there is a Cambro tumbler perfect for your operation.

Elegant Design



HUNTINGTON®
Elegant Design, Unbreakable



LAGUNA®
Hammered Texture



NEWPORT®
Fluted Design



DEL MAR®
Crackled Glass Look

RECOMMENDED USE: Poolside Service, Outdoor Dining, Catering, Bars, Room Service, Hotels & Resorts, Weddings, Corporate Events, Country Clubs, Water Front Dining and Theme Parks.

All Purpose



COLORWARE
Value Tumbler



CAMWEAR® POLYCARBONATE
Virtually Unbreakable



PERSONALIZATION
Available on all tumblers



Camrack® IceExpress Glass Filler

- Dramatically reduces banquet set-up time.
 - Fills 25 glasses with ice all at once.
 - Reduces breakage and risk of contamination.
 - Ice falls directly into glasses with no spills or drips.
- See Camrack® Section for more details

RECOMMENDED USE: Family Dining, Pizzeria, Hospital, Cafeteria, Schools, Nursing Homes.



Add your logo to promote your establishment and build customer loyalty. See personalization page for details.

- Disposable lids fit tightly on Newport, Laguna, and Colorware tumblers, avoiding spills.
- Provides a “green” solution to reduce the waste of using disposable cups for kids’ drinks.
- Reusable tumblers save operators the expense of replacing disposable kids’ cups.
- Tumblers are available in clear, which allows for visibility of contents.
- Doubles as an employee drink cup that requires a lid.
- Lids have tumbler code imprinted on them for easy cross reference.
- Includes a cross slot for straws.
- Tumblers can be personalized with logos or exclusive designs.

Available for ordering in full cases only.
No broken cartons.



Disposable Lids for Colorware Tumblers



LID CODE	CL16	CL900P	CL950P
FITS TUMBLERS	500P / 500P2	900P / 900P2	950P / 950P2
TUMBLER CAPACITY	154 mL	287 mL	290 mL
CASE PACK	1,000	1,000	1,000

Color: Translucent (190).

Disposable Lids for Laguna® Tumblers



LID CODE	CLL16	CLL18	CLL10	CLL12
FITS TUMBLERS	LT6	LT8	LT10	LT12
TUMBLER CAPACITY	177,4 mL	236,6 mL	295,7 mL	354,9 mL
CASE PACK	1,500	2,000	1,000	1,000

Color: Translucent (190).

Disposable Lids for Newport® Tumblers



LID CODE	CLNT5	CLNT8	CLNT10	CLNT12
FITS TUMBLERS	NT5	NT8	NT10	NT12
TUMBLER CAPACITY	189 mL	228 mL	300 mL	373 mL
CASE PACK	1,500	1,000	1,000	1,000

Color: Translucent (190).

Camwear® Polycarbonate Huntington® & SAN Newport® Tumblers

Huntington Tumblers

- Feature the elegant look and feel of glass without the high replacement costs.
- Made of virtually unbreakable polycarbonate
- Lightweight.
- Stacking lugs to prevent sticking
- Three sided drain bottom for easy washing and drying.

Colors: Azure Blue (196), Clear (135).

Capacities calculated to rim.

Personalization available. See crestring section for information and ordering.

Huntington Tumblers are covered by the following U.S. Patents D 386,047.



CODE	HT5CW	HT8CW	HT10CW	HT120CW	HT12CW	HT14CW	HT16CW	HT22CW
MAX DIAMETER	6,0 cm	6,8 cm	7,1 cm	7,6 cm	8,6 cm	8,3 cm	8,4 cm	8,9 cm
MAX HEIGHT	9,0 cm	11,3 cm	12,2 cm	12,8 cm	9,5 cm	12,4 cm	14 cm	17 cm
FULL SIZE CAMRACK®	49S318	36S418	36S434	25S434	25S418	25S434	25S534	25S638
CAPACITY TO RIM	148 mL	237 mL	296 mL	355 mL	355 mL	414 mL	473 mL	652 mL
CASE PACK	36	36	36	36	36	36	36	36

Newport Tumblers

- Fluted design features the upscale look of glass with the safety benefits and cost savings of plastic.
- Impact resistant SAN plastic resists chips and breaks.
- Stacking lugs prevent sticking.
- Sani-Rim lip provides a sanitary drinking surface.

Colors: Clear (152), Blush (409), Amber (153), Slate Blue (401).

Capacities calculated to rim.

Personalization available. See crestring section for information and ordering.

Liquids in SAN cannot exceed 85°C.



CODE	NT5	NT8	NT9	NT10	NT12	NT14	NT16	NT20
MAX DIAMETER	6,4 cm	6,8 cm	8,3 cm	7,1 cm	7,6 cm	7,9 cm	8,3 cm	8,7 cm
MAX HEIGHT	9,4 cm	10,2 cm	8,4 cm	11,6 cm	13 cm	12,7 cm	14,6 cm	16,5 cm
FULL SIZE CAMRACK®	36S318	36S418	25S318	36S434	25S434	25S434	25S534	25S638
CAPACITY TO RIM	189 mL	228 mL	275 mL	300 mL	373 mL	414 mL	485 mL	650 mL
CASE PACK	36	36	36	36	36	36	36	36

SAN Laguna® & Del Mar® Tumblers

Laguna Tumblers

- Hammered texture hides water spots and scratches.
- Made of impact resistant SAN.
- Lightweight and easy to carry.

Colors: Clear (152), Spanish Green (427).

Capacities calculated to rim.

Personalization available. See crestring section for information, ordering and pricing.

Laguna Tumblers are covered by the following U.S. Patent D 405,319.

Liquids in SAN cannot exceed 85°C.



CODE	LT6	LT8	LT10	LT12	LT14	LT16	LT22
MAX DIAMETER	6,3 cm	6,9 cm	7,4 cm	7,9 cm	8,3 cm	8,4 cm	9,3 cm
MAX HEIGHT	10,7 cm	10,9 cm	12,1 cm	12,7 cm	13,1 cm	14 cm	15,4 cm
FULL SIZE CAMRACK®	36S418	36S418	36S434	25S434	25S434	25S534	16S534
CAPACITY TO RIM	177,4 mL	236,6 mL	295,7 mL	354,9 mL	414 mL	473,2 mL	650,6 mL
CASE PACK	36	36	36	36	36	36	36

Del Mar Tumblers

- Cracked glass look features the lightweight handling of plastic.
- Thick sturdy base and rolled rim edge for added stability.
- Made of impact resistant SAN plastic.

Colors: Clear (152), Ruby Red (156), Sapphire Blue (608), Light Amber (609).

Capacities calculated to rim.

Personalization available. See crestring section for information, ordering and pricing.

Del Mar Tumblers are covered by the following U.S. Patent D 478,778 S.

Liquids in SAN cannot exceed 85°C.



CODE	D8	D12	D14	D16	D24
MAX DIAMETER	6,7 cm	7,5 cm	8,3 cm	7,8 cm	8,7 cm
MAX HEIGHT	10,6 cm	12,0 cm	8,3 cm	15,1 cm	16,8 cm
FULL SIZE CAMRACK	36S418	25S434	25S318	25S534	25S638
CAPACITY TO RIM	237 mL	355 mL	414 mL	473 mL	710 mL
CASE PACK	36	36	36	36	36

SAN Colorware Tumblers & Coca-Cola® Tumblers

- A classic value tumbler ideal for casual dining.
- Textured on the outside to resist scratching.
- Made of impact resistant SAN
- Interior stacking lugs for easy storing.
- Sani-Rim lip provides a sanitary drinking surface.

Colors: Blush (409), Slate Blue (401), Clear (152), Amber (153), Ruby Red (156).

Capacities calculated to rim.

Personalization available. See crestring section for information and ordering.

Liquids in SAN cannot exceed 85°C.



CODE (72 PACK)	500P	800P	900P	950P	1200P	1600P	2000P	—
CODE (24 PACK)	500P2	800P2	900P2	950P2	1200P2	1600P2	2000P2	3200P2
MAX DIAMETER	5,7 cm	6,7 cm	8,1 cm	7,0 cm	7,5 cm	8,0 cm	8,6 cm	10 cm
MAX HEIGHT	9,2 cm	10,2 cm	8,25 cm	11,1 cm	13,2 cm	14,6 cm	16,5 cm	18,4 cm
FULL SIZE CAMRACK®	49S318	36S418	25S318	36S418	25S434	25S534	25S638	16S738
CAPACITY TO RIM	154 mL	231 mL	287 mL	290 mL	373 mL	485 mL	650 mL	976 mL
P CODE-CASE PACK	72	72	72	72	72	72	72	—
P2 CODE-CASE PACK	24	24	24	24	24	24	24	24

Coca-Cola® Tumblers

- Colorware Tumblers featuring the Coca-Cola trademark logo in White.
- Available only to Coca-Cola fountain customers for foodservice use.

Colors: Clear (152).

Coca-Cola Logo is imprinted in White only.

These trademarked vessels may not be resold at retail and are available only for distribution to Coca-Cola Fountain customers for foodservice use.

Liquids in SAN cannot exceed 85°C.



CODE	20CC	32CC
MAX DIAMETER	8,6 cm	10 cm
MAX HEIGHT	6,4 cm	7,3 cm
FULL SIZE CAMRACK	25S638	16S738
CAPACITY TO RIM	650 mL	976 mL
CASE PACK	72	24

Camwear® Polycarbonate Tumblers & Camliters®

Camwear Polycarbonate Tumblers

- The look and feel of glass but made of virtually unbreakable polycarbonate.
- Textured exterior surface resists scratching.
- Smooth interior promotes easy cleaning.
- Designed with a Sani-Rim lip for sanitary drinking.

Color: Clear (152).

Capacities calculated to rim.

Personalization available. See crestring section for information and ordering.



CODE	500CW	800CW	850CW	950CW	1200CW	1600CW
MAX DIAMETER	5,7 cm	6,7 cm	8,6 cm	7,0 cm	7,5 cm	7,9 cm
MAX HEIGHT	9,2 cm	10,2 cm	9,7 cm	11,1 cm	13,2 cm	14,6 cm
FULL SIZE CAMRACK®	49S318	36S418	25S418	36S418	36S434	25S534
CAPACITY TO RIM	160 mL	237 mL	269 mL (Heavy Wall)	284 mL	384 mL	503 mL
CASE PACK	48	48	48	48	48	48

Camwear Polycarbonate Camliter Beverage Decanters

- Ideal for serving juice or wine on buffet lines or table side.
- Virtually unbreakable Camwear polycarbonate will not dent or scratch. Lightweight.
- Camliters ship with spill-proof flat lids.
- Pour Spout Lid, ordered separately, protects contents while allowing a free pour.

Color: Clear (135).

Lid Color: White (148).

Pour Spout Lid is not NSF listed.



CODE	CAPACITY	HEIGHT
Camliters complete with lids: (WW1000L, WW250L)		
WW1500CW	1,5 L	25,4 cm
WW1000CW	1 L	24,8 cm
WW500CW	0,5 L	20,0 cm
WW250CW	0,25 L	15,9 cm
Lids		
WW1000LS	(lid w/pour spout for 1,5 L, 1 L, and 0,5 L)	
WW1000L	(lid for 1,5 L, 1 L and 0,5 L)	
WW250L	(lid for 0,25 L)	
Case Pack: 12 Pour Spout Lid must be ordered separately.		



Beverage Dispenser, Pail with Bail & Swirl Bowls®

21 L Beverage Dispenser

- Perfect for mixing and serving concentrated beverages.
- Standard and metric graduations are printed on dispenser.
- Impact resistant polyethylene withstands temperatures from -40°C to 70°C.

Color: White (148).

Personalization available. See cresting section for information and ordering.



CODE	CAPACITY
DSPR6	21 L

Case Pack: 1



DSPR6
Capacity: 21 L

Pail with Bail – Poly

- A large, multi-purpose, 21 L pail, ideal for mixing, storing and transporting.
- Durable polyethylene withstands temperatures from -40°C to 70°C, and is stain resistant.
- Snap-tight, thumb tab cover sold separately.



CODE	CASE PACK
PWB22	6
RFSC12 (cover)	6

Color: White (148).



All graduations are approximate.

Swirl Bowls

- Ideal for hot or cold side dishes, desserts, dips, or fruit.
- Fits on a plate or stacks in place on a buffet station.
- Available in virtually unbreakable Camwear® polycarbonate or break resistant SAN.

Colors:
SRB5CW and SRB13CW available in:
 Clear (135), Black (110), White (148).
SRB5 and SRB13 available in:
 Clear (152), Black (110), White (148).



CLSRB5 Disposable lid not NSF.



CODE	CAPACITY	CASE PACK
Camwear Polycarbonate		
SRB5CW	148 mL	24
SRB13CW	384 mL	24
SAN		
SRB5	148 mL	24
SRB13	384 mL	24
Disposable Lid		
CLSRB5	—	1,000

Disposable Lid Color: Clear (152).

Camwear® Polycarbonate Wine Buckets, Punch Bowls & Bud Vase

Wine Buckets

- Chill and showcase wine or champagne.
- Tough Camwear polycarbonate won't crack or break and is easy to clean.
- Chrome stand available for space saving table side service.

Color: Clear (135).
 Stand Color: Chrome (136).
 Personalization available. See cresting section for information and ordering.



CODE	DIMENSION D x H
Bucket	
WC100CW	20,3 x 23,2 cm
WC100CWNH (w/o handles)	20,3 x 22,9 cm
Stand	
WCS30	—
Case Pack: 1	



WC100CW



WC100CWNH

WCS30

Pebbled Pedestal Punch Bowls

- Perfect for parties, weddings and receptions.
- Made of virtually unbreakable Camwear polycarbonate.
- Attractive pebbled exterior is scratch resistant and smooth interior is easy to clean.

Color: Pebbled (176).
 Capacities are calculated to rim.
 Personalization not available.



CODE	INSIDE DIAMETER	APPROX. CAPACITY	CASE PACK
PPB15	38,1 cm	10,6 L	1
PPB18	45,7 cm	19,1 L	1
PPB23	58,4 cm	37,8 L	1

Bud Vase

- Ideal for dining rooms, cafeteria tables and patient or room service trays.
- Made of virtually unbreakable Camwear polycarbonate.
- Fill with a fresh rose bud or a colorful faux flower.

Colors: Clear (135), White (148).



White (148)

Clear (135)



CODE	DESCRIPTION	CASE PACK
BV6CW	15,24 cm Bud Vase	12



Food Presentation



Deli Crocks & Platter
ShowFest® Display Bowls & Trays
Camwear® Polycarbonate Bowls
Bell Shaped, Budget & Fiberglass Bowls
Camwear® Polycarbonate Display Covers & Trays
Crocks & Ladles
Camwear® Polycarbonate Serving Spoons,
Tongs & High Heat Camtensils®
Lugano® Tongs
Camwear® Polycarbonate Shakers/Dredges & Condiment Jars

Deli Crock & Platter

- Prep, store and serve all in one with contemporary style at an economical price.
- Crock and platter are made of SAN, making them impact, stain and chip resistant.
- Ideal for supermarket delis, sandwich shops, buffets and catered events.
- Handled covers are made of crystal clear, virtually unbreakable Camwear® polycarbonate.

Crock and Platter Colors: Clear (152), Black (110), White (148), Red (404).

Crock Cover Color: Clear (135).

Deli Crock is covered by the following U.S. Patents D 504,283 S, D 503,871 S & D 494,419 S. Scalloped Food Service Cover is covered by the following U.S. Patent D 509,705 S.



Prep, stack, store and serve all in one.



Interstacking saves storage space.



Avoid cross contamination and keep food fresh by using clear cover with handle.



Lid can be used as a riser to provide additional height on the buffet table or in a deli display case.



Cover doubles as a false bottom for presentation and to reduce waste.

Crocks & Platter



CODE	DC5	DC10	DP15
DESCRIPTION	Crock	Crock	Platter
DIMENSIONS W x L x H	17,5 x 26 x 8 cm	26,5 x 33,5 x 8 cm	40 x 30,5 x 5,5 cm
APPROXIMATE CAPACITY	2 L	4,6 L	3,2 L

Case Pack: 6

Covers



CODE	DCC5 fits DC5	DCC10 fits DC10
DIMENSIONS W x L x H	15 x 23,8 x 3,5 cm	24 x 31 x 3,5 cm
APPROXIMATE CAPACITY	0,85 L	1,9 L

Case Pack: 6



ShowFest® Display Bowls & Trays

- Showcase cold deli, buffet and salad bar items.
- Made from SAN for impact, stain, break & chip resistance.
- Variety of shapes & sizes to make the best use of display area.

Colors: Black (110), White (148).

Personalization not available.

Triangle trays are covered under U.S. Patent D 419,364.



Scalloped Ovals



CODE	SFV1015
DIM. W x L x H	25,4 x 38 x 5 cm
APPROX. CAPACITY	2,8 L
Case Pack: 6	

Scalloped Rectangles



CODE	SFR1012
DIM. W x L x H	25,4 x 31,8 x 7,6 cm
APPROX. CAPACITY	4,3 L
Case Pack: 6	



Octagonals



CODE	SFG1012	SFG1015	SFG820	SFG1220
DIM. W x L x H	25,4 x 30,5 x 5 cm	25,4 x 38 x 5 cm	20,3 x 50,8 x 5 cm	30,5 x 50,8 x 5 cm
APPROX. CAPACITY	2,8 L	3,3 L	3,7 L	5,8 L
Case Pack: 6				

Triangles



CODE	SFT1010	SFT1212	SFT1515
DIM. W x L x H	25,4 x 30,5 x 6,4 cm	30,5 x 38 x 6,4 cm	38 x 50,8 x 6,4 cm
APPROX. CAPACITY	1,9 L	2,8 L	4,2 L
Case Pack: 6			

Camwear® Polycarbonate Bowls

Round Pebbled Bowls

- Textured on the outside for an elegant look, smooth on the inside for easy cleaning.
- Made of virtually unbreakable Camwear polycarbonate for years of dependable service.
- Ideal for fruit, salads, snacks and desserts.

Color: Pebbled (176).

Capacities are calculated to rim.



Ribbed Bowls

- Stylish, contemporary appearance for a dramatic presentation.
- Made of virtually unbreakable Camwear polycarbonate that won't break like glass.
- Bowls are durable and lightweight. Will not chip and crack like acrylic.
- Resistant to stains, acids and odors.

Colors: Clear (135), Black (110), White (148)*.

* Rectangular Ribbed Bowls are not available in White (148).

Capacities are calculated to rim.



Round Pebbled Bowls

CODE	PSB6	PSB8	PSB10	PSB12
INSIDE DIAMETER	15,2 cm	20,3 cm	25,4 cm	30,5 cm
APPROXIMATE CAPACITY	556 mL	1,7 L	3,0 L	5,5 L
CASE PACK	12	12	12	12

Round Pebbled Bowls



CODE	PSB15	PSB18	PSB23
INSIDE DIAMETER	38,1 cm	45,7 cm	58,4 cm
APPROXIMATE CAPACITY	10,6 L	19,1 L	37,8 L
CASE PACK	4	4	4

Color: Pebbled (176).

Rectangular Ribbed Bowls



CODE	RSB912CW	RSB1014CW	RSB1419CW
OUTSIDE DIAMETER	22,9 x 30,8 cm	27,3 x 37 cm	36,2 x 49,2 cm
APPROXIMATE CAPACITY	2,7 L	4,7 L	11,3 L
CASE PACK	12	4	4

Rectangular Ribbed Bowls are not available in White (148).

Round Ribbed Bowls



CODE	RSB6CW	RSB8CW	RSB10CW	RSB12CW
INSIDE DIAMETER	15,2 cm	20,3 cm	25,4 cm	30,5 cm
APPROXIMATE CAPACITY	564 mL	1,6 L	3,0 L	5,5 L
CASE PACK	12	12	12	12



CODE	RSB15CW	RSB18CW	RSB23CW
INSIDE DIAMETER	38,1 cm	45,7 cm	58,1 cm
APPROX. CAPACITY	10,6 L	19,1 L	37,8 L
CASE PACK	4	4	4

Bell Shaped, Budget & Fiberglass Bowls

Camwear® Polycarbonate Bell-Shaped Pebbled Bowls

- Perfect for showcasing fruits and salads.
- A versatile alternative to Cambro traditional Round Pebbled Bowls.
- Made from virtually unbreakable Camwear polycarbonate.

Color: Pebbled (176).
 Personalization not available.
 Capacities are calculated to rim.



CODE	BSB10	BSB12	BSB18
INSIDE DIAMETER	25,0 cm	30,5 cm	45,7 cm
APPROX. CAPACITY	2,0 L	3,8 L	11,8 L
CASE PACK	12	4	4

Budget Salad Bowls

- An economical serving choice for fruit, salads, snacks and desserts.
- Impact resistant FDA approved material resists stains, acids and odors.

Colors: Birch (174), Black (110).
 Personalization not available.
 Capacities are calculated to rim.



CODE	SB55	SB60	SB80
INSIDE DIAMETER	14,5 cm	15,2 cm	20,3 cm
APPROX. CAPACITY	325 mL	375 mL	925 mL

Case Pack: 72



Fiberglass Bowls

- Combines the look of warm wood grains with the durability of fiberglass.
- Colors won't fade even after years of service and washing.

Color: Dark Basketweave (301).
 Personalization not available.
 For a swatch of this color and pattern, see Camtray® group section.
 Capacities are calculated to rim.



CODE	6F	8F
INSIDE DIAMETER	15,6 cm	20,3 cm
APPROX. CAPACITY	425 mL	925 mL

Case Pack: 12



Camwear® Polycarbonate Display Covers & Trays

- Display covers protect freshness of pastries, breads and desserts.
- Virtually unbreakable Camwear polycarbonate features the upscale look of glass.
- Openings on side or end provide quick and easy access to contents without removing cover.

Display Covers

Color: Clear (135).

Personalization available. See crestring section for information and ordering.

* Dimensions include handle(s).
Handle height is 2,06 cm.

Market Trays

Colors: Salmon (149), Yellow (145), Blue (142), Green (140), White (148), Black (110).

Colors NSF listed for food contact: White (148), Blue (142), Green (140).

Display Trays

Colors: Clear (135), Black (110).

Personalization not available.

** Special order item not carried in stock – non-returnable.



Display Trays are stackable.
Refer to Market Tray for information.



RD1220CW



RD1220CWH



RD1200CW



DD1220BECW



Display Tray – DT1220CW



Dome with side cut – DD1220SCW

CODE	APPROXIMATE DIMENSIONS W x L x H*	DESCRIPTION	CASE PACK
Display Covers			
RD1200CW	30,5 x 30,5 x 20,9 cm	Cake cover	1
DD1220CW	55,6 x 37,5 x 20,3 cm	Dome cover	1
DD1220ECW	55,6 x 37,5 x 20,3 cm	Dome w/end cut	1
DD1220BECW	55,6 x 37,5 x 20,3 cm	Dome w/2 ends cut	1
DD1220SCW	55,6 x 37,5 x 20,3 cm	Dome w/side cut	1
DD1826CW	67,9 x 47,9 x 22,5 cm	Dome cover	1
RD926CW	67,2 x 25,4 x 15,9 cm	Rectangular cover	1
RD1220CW	55,6 x 35,9 x 14,9 cm	Rectangular cover	1
RD1220CWH	55,6 x 35,9 x 12,7 cm	Rectangular w/hinge	1
RD1826CW	67,2 x 47,9 x 15,9 cm	Rectangular cover	1
RD1826CWH	67,9 x 47,6 x 13,0 cm	Rectangular w/hinge	1
Display Tray – Fits with all 1220 covers			
DT1220CW	30,5 x 50,8 cm	Tray	1
Market Tray – Fits with all 1826 covers			
1826MT**	65,3 x 45,2 x 2,7 cm	Tray	6

Crocks & Ladles

Crocks

- Ideal for use with salad bars, on buffet tables or at food stations.
- Resists stains and odors caused by vinegar, salad oils, or mayonnaise.
- Made of high impact FDA accepted material.
- Smooth surface is easy-to-clean.

Solid Color Crock Colors:
Cranberry (416), Black (110), Beige (133),
Reddish Brown (195).

Clear Crock Color: Clear (152).

Lid Color: White (148).

.....
Personalization available.
See personalization section for details.
.....

* Lids for Solid Color and Clear Crocks are not interchangeable.



CODE	HEIGHT	TOP DIAMETER	CUT OUT DIAMETER
Solid Color Crock with Lid			
CP12	13,2 cm	12,9 cm	12,1 cm
CP15	11 cm	16,8 cm	15,7 cm
CP27	17,2 cm	16,8 cm	15,6 cm
Clear Color Crock with Lid			
CCP12	13,7 cm	13,3 cm	12,4 cm
CCP15	11,1 cm	17,2 cm	15,9 cm
CCP27	17,5 cm	17,2 cm	15,7 cm

CODE	CAPACITY	CASE PACK
Solid Color Crocks		
CP12	1,1 L w/Lid	12
CP15	1,4 L w/Lid	6
CP27	2,4 L w/Lid	6
Lids for Solid Color Crocks		
CPL12*	Fits Colored CP12 Crock	12
CPL27*	Fits Colored CP15 & CP27	12
Clear Crocks		
CCP12	1,1 L w/Lid	12
CCP15	1,4 L w/Lid	6
CCP27	2,4 L w/Lid	6
Lids for Clear Crocks		
CCPL12*	Fits Clear CCP12 Crock	12
CCPL27*	Fits Clear CCP15 & CCP27	12

Camwear® Polycarbonate Ladles

- Portion control bowls serve the perfect amount of dressing or food ingredient.
- Angled for easy handling.
- Designed with a side rest so ladles don't slip into crocks or serving bowls.
- Made of virtually unbreakable Camwear polycarbonate for years of dependable service.

Colors: Black (110), Beige (133),
Clear (135), White (148),
Reddish Brown (195).

.....
* Cambro's assortment pack offers 8 imprinted ladles and 4 with no imprinting. 8 imprints include: 1 each Thousand Island, French, House, Italian, Bleu Cheese, Ranch, Low Cal, Caesar. This makes a perfect start-up set for a salad bar.
.....

Custom Order Ladle Imprints – See cresting section for information and ordering. Maximum imprint area is 2,5 x 1,2 cm. Six dozen minimum.
.....

No broken cartons on assortment pack or imprinted ladles. Special order item not carried in stock, non-returnable.
.....



* Imprinted Ladles shown.

CODE	DESCRIPTION	LENGTH	CAPACITY
LD85	Plain	21,6 cm	25 mL
LD85A*	Assortment	21,6 cm	25 mL
LD105	Plain	26,8 cm	30 mL
LD105A*	Assortment	26,8 cm	30 mL
LD130	Plain	33 cm	30 mL

Case Pack: 12

Camwear® Polycarbonate Serving Spoons, Tongs & High Heat Camtensils®

Camwear Serving Spoons

- Made of virtually unbreakable polycarbonate, Camwear spoons won't tarnish, bend or dent.
- A wide handle and molded in thumb rest ensures a solid, ergonomic grip.
- Spoons feature a notched back to rest on pans.
- Spoon capacities are approximate and are not intended for measuring.

Colors: Black (110), Beige (133), Clear (135), Red (404), White (148).

Personalization available. See crestring section for information, ordering and pricing.



Camwear Polycarbonate Perforated Serving Spoons



CODE	SPOP10CW	SPOP11CW	SPOP13CW
DESCRIPTION	25,5 cm Perforated Buffet Spoon	28 cm Perforated Deli Spoon	33 cm Perforated Deli Spoon
DIMENSIONS	26 x 4,3 cm	28,3 x 7,3 cm	33,3 x 7,3 cm

Case Pack: 12

Camwear Polycarbonate Serving Spoons



CODE	SP08CW	SP010CW	SP011CW	SP013CW
DESCRIPTION	20,5 cm Salad Spoon	25,5 cm Buffet Spoon	28 cm Deli Spoon	33 cm Deli Spoon
DIMENSIONS	20,6 x 3,8 cm	26 x 4,3 cm	28,3 x 7,3 cm	33,3 x 7,3 cm

Case Pack: 12

High Heat Camtensil Spoons and Turners

- Ideal for preparing and serving hot and cold foods.
- Made of a durable high heat material that withstands temperatures from -40°C to 190°C.
- Handle includes a hole for hanging when not in use and notches to rest on pans.

Colors: Amber (150), Black (110).

Personalization not available.



High Heat Camtensil Spoons and Turners

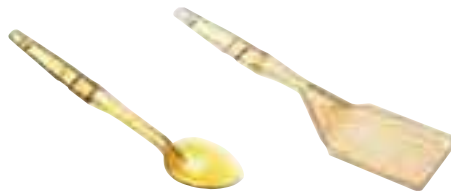

CODE	SP013	SPA14
DESCRIPTION	33 cm Solid Spoon	35,5 cm Solid Turner
DIMENSIONS	33,3 x 7,3 cm	35,9 x 8,9 cm

Case Pack: 12

High Heat Camtensil Perforated Spoons and Slotted Turners



CODE	SPOP13	SPASL14
DESCRIPTION	33 cm Perforated Spoon	35,5 cm Slotted Turner
DIMENSIONS	33,3 x 7,3 cm	35,9 x 8,9 cm

Case Pack: 12

Lugano® Tongs

- Colored tongs are made from a durable heat resistant material that withstands temperatures up to 100°C.
- Ideal for serving cold and hot food, even from steam tables.
- Clear tongs are made from virtually unbreakable polycarbonate, which is safe to 99°C.

Lugano Flat and Scallop Grip Tongs

- Easily grasp hard to hold items such as salad greens and tomatoes.
- Scallop Tongs feature an ergonomic design and secure finger grip.
- Flat Tongs are ribbed to provide a secure hold.

Colors: Black (110), Beige (133), Clear (135), Red (404), White (148).

Two year warranty on tongs.



Flat Grip Tongs



CODE	TG6	TG9
LENGTH	15 cm	23 cm

Case Pack: 12

Scallop Grip Tongs



CODE	6TGS	9TGS	12TGS
LENGTH	15 cm	23 cm	30,5 cm

Case Pack: 12

Lugano Angled and Easy-Grasp Tongs

- Angled tongs feature an ergonomic design that makes it easy to serve a variety of foods.
- Easy-Grasp Tongs provide a secure grip for hard to hold items.

Colors: Black (110), Beige (133), Clear (135), White (148).

Two year warranty on tongs.

Angled and Easy-Grasp Lugano Tongs are covered under U.S. Patent D 530,994 S.



Angled Tongs



CODE	TGA8	TGA11
DESCRIPTION	Angled Tong	Angled Tong
DIMENSIONS	21 cm	27,5 cm

Case Pack: 12

Easy-Grasp Tongs



CODE	TGG6	TGG9
DESCRIPTION	Easy-Grasp Tong	Easy-Grasp Tong
DIMENSIONS	15 cm	24 cm

Case Pack: 12



Camwear® Polycarbonate Shakers/Dredges & Condiment Jars

Camwear Polycarbonate Shakers/Dredges

- A staple in the kitchen, at the condiment station or on the dining table.
- Clear virtually unbreakable Camwear® polycarbonate and color coded lids make it easy to identify contents.
- Dishwasher safe and unaffected by food acids.

Shaker Color: Clear (135).

Personalization available. See cresting section for information, ordering and pricing.



96SKRLF
Fine Ground



96SKRLD
Salt & Pepper



96SKRLM
Med. Ground



96SKRLC
Cheese



96SKRLP
Parsley



CODE

LID COLOR

Shakers complete with lids (approx. capacity 300 mL)

96SKRF (w/fine ground lid)	Green (407)
96SKRP (w/parsley lid)	White (148)
96SKRD (w/salt & pepper lid)	Beige (406)
96SKRC (w/cheese lid)	Yellow (405)
96SKRM (w/medium ground lid)	Rose (408)

Shaker Replacement Lids (Shaker Lids are not interchangeable with Camliter® Lids)

96SKRLF fine ground lid	Green (407)
96SKRLP parsley lid	White (148)
96SKRLD salt & pepper lid	Beige (406)
96SKRLC cheese lid	Yellow (405)
96SKRLM medium ground lid	Rose (408)

Case Pack: 12

Camwear Polycarbonate Condiment Jar

- Use to hold condiments such as mustard, ketchup, dressings, jam or salsa.
- Made of clear, virtually unbreakable Camwear polycarbonate.
- Lids are slotted to hold serving spoons when not in use.

Color: Clear (135).

Personalization available. See cresting section for information, ordering and pricing.



CODE	APPROXIMATE CAPACITY	SIZE H x D	CASE PACK
Condiment Jar Set			
CJ80CW	240 mL	10,2 x 8,3 cm	24



Trays

Tray Product Guide

Personalization

Polyester Versa Trays

Microban® Antibacterial Camguard® Versa Trays

Polyester Decorated Versa Trays

Polyester Versa Lite Trays

Century Fun Trays

Camtrays® Trays

Non-Skid Versa Camtrays®

Dietary and Camlite® Trays

Camtread® / Treadlite™ / Polytread Trays

Wood Trays

Corfu / Mykonos / Capri / Madeira Laminated Trays

Fast Food Trays

Compartment Trays

Polycarbonate Camwear® Trays

Market Trays



Choose the Right Tray for Your Business

Cambro is the global leader in manufacturing trays for the food service industry, offering the largest selection of materials, sizes, colors, shapes and personalization processes. Cambro's breadth of assortment provides the clear choice for the right tray for every need and budget.

Consider the following to select the right tray for your operation:

Step 1: What Will the Tray Be Used For?

In order to choose the correct tray, first identify the correct application.

Service Tray

Used by employees to carry items to serve to guests:

Non-Slip Tray

Patron Tray

Used by customers to carry menu items:

Smooth Surface Tray

Step 2: Who Will Be Using the Tray?

To determine the appropriate tray material, it is critical to identify who will be using the tray.

Children

Students

Military

Office Employees

Wait Staff

Step 3: How Will the Tray Be Used and Washed?

Consider how the tray will be used, and whether it will endure mild or excessive use and abuse. Determine how often the trays will be washed per day.

Extensive:

Wash as often and as frequently as needed

Normal:

Wash up to 3 times per day

Minimal:

Wash once per day

Step 4: Determine the Budget per Tray

Ensure that the correct tray has been selected for the right application. Selecting a low cost tray for a heavy application is not the most cost effective option. Tray pricing varies according to the following factors:

Manufacturing process

Material type and grade

Tray size

Personalization options

Warranty

Step 5: Personalization

Cambro offers high quality personalization on most of the trays that we manufacture. Look for the personalization logo throughout the brochure. 

Step 6: Additional Features to Consider

Evaluate the importance of the following features to determine the best tray for your operation.

Stacking lugs - Promote air circulation for fast drying and perfect stacking

Surface impact resistance

Edge breaking resistance

Scratch and stain resistance

Type of Warranty

Technical test descriptions

All Cambro trays are submitted to an array of tests described to the right. The results are indicated on each tray page under Technical Test Results.



Versa Trays



Versa Trays Anitmicrobial



Versa Lite Trays



Laminated Capri Trays



Laminated Corfu Trays



Laminated Mykonos Trays



Fast Food Trays



Tablotherm

TESTS DESCRIPTIONS

Thermal Shock Resistance Test:

Test consists of applying a radical temperature change during a short period of time to the tray, by taking out the tray from icy water (0°C) and placing it into boiling water (100°C) and measuring any deformation.

Break Resistance Test: Test consists of dropping a metal ball from specific heights onto the tray and measuring any deformation.

Scratch Resistance Test:

Observe scratches and abrasions as a result of friction between porcelain dinnerware and the tray surface.

Test consists of moving a porcelain dish placed on tray from left to right under hand pressure and measuring any abrasion on tray surface.

DISHWASHER SAFE DESCRIPTIONS

Extensive: Wash as often and as frequently as needed.

Normal: Wash up to 3 times per day.

Minimal: Wash once per day.

Tray Product Guide

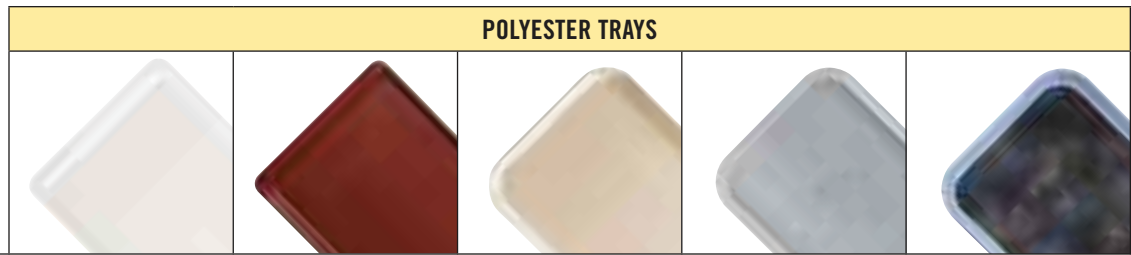

POLYESTER TRAYS					
Tray Description	Versa Trays Ecologic Series Page 185	Versa Tray Plus Page 186	Versa Trays VT/GP Pages 188-189	Antibacterial Versa Trays VT/GP Page 187	Versa Trays with Décor GP Page 190
Material	Natural Material + Polyester	SMC-High Performance Fiberglass Reinforced Polyester	SMC-High Performance Fiberglass Reinforced Polyester	SMC-High Performance Fiberglass Reinforced Polyester	SMC-High Performance Fiberglass Reinforced Polyester + Melamine Surface
Surface	Smooth	Smooth	Smooth	Smooth	Smooth
Performance	Excellent	Excellent	Excellent	Excellent	Excellent
Recommended Use	(H) (S) (U) (CS) (M)	(H) (S) (U) (CS) (M)	(H) (S) (U) (CS) (M)	(H) (S) (U) (CS) (M)	(H) (S) (U) (CS) (M)
Personalization	Yes Δ	No	Yes (Heat resistance: 90°C)	No	No
Years Guaranteed**	5	5	5	5	5
Stacking* Lugs	Yes	Yes	Yes	Yes	Yes
Dishwasher Safe	Yes – Extensive	Yes – Extensive	Yes – Extensive	Yes – Extensive	Yes – Extensive
Chemical Resistance	Excellent	Excellent	Excellent	Excellent	Excellent
Drying Test	Excellent	Excellent	Excellent	Excellent	Excellent
Thermal Shock Resistance	Excellent	Excellent	Excellent	Excellent	Excellent
Break Resistance	Excellent	Excellent	Excellent	Excellent	Excellent
Scratch Resistance	Excellent	Excellent	Excellent	Excellent	Excellent
Stain Resistance	Excellent	Excellent	Excellent	Excellent	Excellent
Heat Resistance	-40° to +140°C ‡	-40° to +140°C ‡	-40° to +140°C ‡	-40° to +140°C ‡	-40° to +90°C ‡
Number of Sizes	5	5	21	6	3
Number of Shapes	4	4	10	3	1
Number of Colors	4	3	10	1	15

*Stacking lugs allow free air circulation and perfect stacking.
** Prorated warranty.

‡ Not recommended for heated cart.
Δ Contact your Cambro representative for pricing.

If you are using Thermo-Chemical Disinfection Equipment, please contact us. We will assist you finding the right tray for your application.

Icon Directory for Recommended Use:



Hospitals



Schools



Universities



Canteens /
Cafeterias /
Self-Serve



Military



Hotel /
Room Service



Banquet
Service



Restaurants /
Cafes



Bars / Clubs /
Pubs



Catering



Brasseries



Prisons /
Corrections



Home Meal
Delivery



Quick Serve
Restaurants



Food Courts /
Snack Shops







Deli / Buffet
Displays

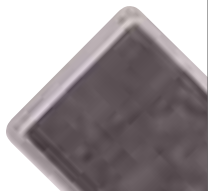

Kitchen
Operation

Tray Product Guide

	POLYESTER TRAYS				FIBERGLASS TRAYS
					
Tray Description	Non-Slip Surface GP Page 191	Non-Skid Versa Lite Trays VL/GL Page 195	Versa Lite Trays VL/GL Pages 192-193	Versa Lite Trays with Non-Slip Rubber Surface VL/GL Page 196	Camtray Pages 197-201
Material	SMC-High Performance Fiberglass Reinforced Polyester + Non-Slip Surface	SMC-Standard Performance Fiberglass Reinforced Polyester + Non-Slip Surface	SMC-Standard Performance Fiberglass Reinforced Polyester	SMC-Standard Performance Fiberglass Reinforced Polyester + Non-Slip Rubber Surface	Fiberglass Layers + Polyester Resin
Surface	Non-Slip	Non-Skid	Smooth	Non-Slip Rubber	Smooth
Performance	Excellent	Excellent	Excellent	Excellent	Excellent
Recommended Use	(H) (S) (U) (CS) (M)	(S) (U) (CS) (M) (RS)	(H) (S) (U) (CS) (M) (C) (RS)	(BS) (RC) (BC) (C) (B)	(H) (S) (U) (CS) (M) (RS)
Personalization	Yes Δ	Yes Δ	Yes (Heat resistance: 90°C)	No	Yes
Years Guaranteed**	2	2	3	3	5
Stacking* Lugs	Yes	Yes	Yes	Yes	Yes
Dishwasher Safe	Yes – Extensive	Yes – Normal	Yes – Normal	Yes – Normal	Yes – Extensive
Chemical Resistance	Good	Good	Good	Good	Good
Drying Test	Excellent	Excellent	Excellent	Excellent	Excellent
Thermal Shock Resistance	Excellent	Good	Good	Good	Excellent
Break Resistance	Excellent	Good	Good	Good	Excellent
Scratch Resistance	Good	Good	Good	Good	Excellent
Stain Resistance	Good	Good	Good	Good	Excellent
Heat Resistance	-40° to +80°C ‡	-40° to +80°C ‡	-40° to +130°C ‡	-40° to +100°C ‡	-10° to +100°C ‡
Number of Sizes	4	4	18	7	40
Number of Shapes	1	3	8	3	5
Number of Colors	5	4	9	2	55

*Stacking lugs allow free air circulation and perfect stacking.

** Prorated warranty.

‡ Not recommended for heated cart.

Δ Contact your Cambro representative for pricing.

If you are using Thermo-Chemical Disinfection Equipment, please contact us. We will assist you finding the right tray for your application.

Materials Review

POLYESTER TRAYS

- Antimicrobial VT/GP Trays
- VT/GP Trays with Décor (1)
- VT/GP Non-Skid Versa Trays (2)
- Versa Tray Ecologic Series (3)
- Versa Tray Plus (3)
- VT/GP Trays







High performance polyester trays are made of rugged reinforced mat with long fibers and additional fiberglass to provide extremely high shock-resistance. Colored isophthalic polyester resin offers high chemical and UV-resistance.

- (1) Melamine resin layer on top increases protection against stains, abrasions and scratches.
- (2) The non-slip surface has a guarantee of 2 years against deterioration.
- (3) Trays are guaranteed 5 years against breakage under normal use.

VERSA LITE TRAYS

- VL/GL Trays
 - VL/GL Trays with Non-Slip Surface
- Standard performance polyester trays are made of fiberglass and standard polyester resin.

Tray Product Guide

	FIBERGLASS TRAYS					POLYPROPYLENE TRAYS
						
Tray Description	Non-Skid Versa Camtrays® Page 202	Dietary Trays Page 203	Camlite Trays Page 203	Camtread Trays Page 204	Treadlite™ Trays Page 205	Polytread® Trays Page 205
Material	Fiberglass Layers + Polyester Resin + Non-Slip Surface	Fiberglass Layers + Polyester Resin	Fiberglass Layers + Polyester Resin	Fiberglass Layers + Polyester Resin + Non-Slip Rubber Surface	Fiberglass Layers + Polyester Resin + Non-Slip Rubber Surface	Polypropylene + Non-Slip Rubber Surface
Surface	Non-Skid	Smooth	Smooth	Non-Slip Rubber	Non-Slip Rubber	Non-Slip Rubber
Performance	Excellent	Excellent	Excellent	Excellent	Good	Good
Recommended Use	(S) (U) (CS) (M) (RS)	(H) (S) (U) (CS) (M) (RS)	(H) (S) (U) (CS) (M) (RS)	(BS) (RC) (BC) (C) (B)	(RC) (BC) (B)	(RS) (RC) (BC)
Personalization	Yes Δ	No	No	No	No	No
Years Guaranteed**	2	3	3	5	1	1
Stacking* Lugs	Yes	Yes	Yes	Yes	Yes	Yes
Dishwasher Safe	Yes – Extensive	Yes – Extensive	Yes – Extensive	Yes – Extensive	Yes – Minimal	Yes – Minimal
Chemical Resistance	Good	Good	Good	Good	Good	Good
Drying Test	Excellent	Excellent	Excellent	Excellent	Good	Good
Thermal Shock Resistance	Excellent	Excellent	Excellent	Excellent	Good	Good
Break Resistance	Excellent	Good	Good	Good	Good	Good
Scratch Resistance	Good	Good	Good	Excellent	Good	Good
Stain Resistance	Good	Excellent	Excellent	Good	Good	Good
Heat Resistance	-40° to +80°C ‡	-10° to +100°C ‡	-10° to +100°C ‡	-10° to +100°C ‡	-10° to +80°C ‡	-10° to +80°C ‡
Number of Sizes	2	7	7	17	2	6
Number of Shapes	4	1	2	5	1	2
Number of Colors	3	55	9	2	2	2

* Stacking lugs promote air circulation and perfect stacking.

Δ Contact your Cambro representative for pricing.

‡ Not recommended for heated cart.

** Prorated warranty.

Materials Review

FIBERGLASS TRAYS

- Camtray
- Non-Skid Versa Camtray
- Dietary Trays
- Camlite Trays
- Market Trays
- Camtread Trays (1)
- Treadlite Trays (2)

Made of rugged fiberglass interior to provide a tough inner foundation and smooth surface, coupled with

polyester resin to resist impact, stains and chemicals. Guaranteed for 5 years.

(1) Camtread Trays molded in non-slip rubber surface are guaranteed 5 years against delamination.







(2) Trays molded in non-skid surface are guaranteed 1 year prorated.

POLYPROPYLENE TRAYS

- Polytread Trays

Fast food trays have a textured surface to hide scratches and provides an additional grip to prevent slipping. Polytread trays have non-slip rubber surface bonded directly into the tray which will not delaminate.

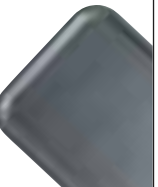
Tray Product Guide

	WOOD TRAYS		LAMINATED TRAYS				POLYPROPYLENE
							
Tray Description	Wood Trays with Smooth Surface Page 206	Wood Trays with Non-Slip Surface Pages 206-207	Corfu Laminated Trays with Non-Slip Rubber Surface Page 208	Capri Laminated Trays with Smooth Surface Pages 210-211	Mykonos Laminated Trays with Non-Slip Surface Page 209	Madeira Laminated Trays with Textured Wood Surface Page 212	Fast Food Trays Page 213
Material	Veneer Beechwood	Veneer Beechwood / Mahogany + Non-Slip Surface	Laminate + Non-Slip Rubber Surface	Laminate	Laminate + Non-Slip Surface	Laminate	Polypropylene
Surface	Smooth	Non-Slip	Non-Slip Rubber	Smooth	Non-Slip	Textured	Textured
Performance	Good	Good	Excellent	Good	Good	Good	Good
Recommended Use	(BS) (RC) (C)	(BS) (RC) (BC) (C) (B)	(CS) (BS) (RC) (BC) (C)	(CS) (RS) (RC) (BC) (C) (B)	(BS) (RC) (BC) (C)	(CS) (RS) (RC) (BC)	(QS) (FC)
Personalization	No	Yes	Yes†	Yes	Yes	No	Yes
Years Guaranteed**	3	3	3	3	3	3	3
Stacking* Lugs	No	No	No	No	No	No	Yes
Dishwasher Safe	Yes – Normal	Yes – Minimal	Yes – Normal	Yes – Normal	Yes – Minimal	Yes – Normal	Yes – Minimal
Chemical Resistance	Excellent	Good	Excellent	Excellent	Good	Excellent	Excellent
Drying Test	Good	Good	Good	Good	Good	Good	Good
Thermal Shock Resistance	Good	Good	Good	Good	Good	Good	Good
Break Resistance	Good	Good	Good	Good	Good	Good	Good
Scratch Resistance	Good	Good	Good	Good	Good	Good	Good
Stain Resistance	Good	Good	Good	Excellent	Good***	Excellent	Good
Heat Resistance	-10° to +100°C ‡	-10° to +100°C ‡	-10° to +100°C ‡	-10° to +100°C ‡	-10° to +100°C ‡	-10° to +100°C ‡	-10° to +80°C ‡
Number of Sizes	14	15	8	22	15	9	4
Number of Shapes	4	4	2	5	3	4	2
Number of Colors	1	2	2	11	6	4	14

* Stacking lugs allow free air circulation and perfect stacking

** Prorated warranty.

*** Limited stain resistance for Birch (E75).

‡ Not recommended for heated cart.

† Only back side of Corfu trays can be personalized.

Materials Review

WOOD TRAYS

- Smooth Surface
- Clear Non-Slip Surface

Made of several layers of genuine beechwood veneer / mahogany combined with synthetic resin molded under high pressure and temperature. The surface is sealed with a double layer of high pressure melamine to allow regular washing.

LAMINATED TRAYS

- Corfu*
- Mykonos
- Capri
- Madeira

Made of compressed layers of melamine saturated paper combined with synthetic resin molded under high pressure and temperature.

The surface is sealed with a double layer of high pressure melamine to allow regular washing.

* Non-slip rubber surface bonded directly into tray will not delaminate.







Note: All laminated trays must be dried before stacking.

POLYPROPYLENE TRAYS

- Fast Food Trays

Fast food trays have a textured surface to hide scratches and provides an additional grip to prevent slipping. Polytreed trays have non-slip rubber surface bonded directly into the tray which will not delaminate.

Tray Product Guide

	COMPARTMENT TRAYS				SERVICE TRAYS	DISPLAY TRAYS
						
Tray Description	Polycarbonate Trays Pages 214-215	ABS Page 216	Co-Polymer Trays Pages 216-217	Heat Resistant Trays Page 218	Polycarbonate Trays Page 219	Market Trays Page 219
Material	Polycarbonate	ABS	Co-Polymer	Heat Resistant Plastic	Polycarbonate	Fiberglass Layers + Polyester Resin
Surface	Textured	Textured	Textured	Textured	Textured	Smooth
Performance	Excellent	Excellent	Excellent	Excellent	Excellent	Excellent
Recommended Use	(S) (U) (M) (P)	(S) (U) (M) (P)	(S) (U) (HD) (P)	(P)	(S) (U) (CS) (M) (QS) (FC)	(D)
Personalization	No	No	No	No	No	No
Years Guaranteed**	3	3	3	3	3	3
Stacking* Lugs	Yes	Yes	Yes	Yes	Yes	Yes
Dishwasher Safe	Yes – Extensive	Yes – Extensive	Yes – Minimal	Yes – Extensive	Yes – Extensive	Yes – Extensive
Chemical Resistance	Good	Excellent	Excellent	Very Good	Good	Good
Drying Test	Excellent	Excellent	Excellent	Very Good	Excellent	Excellent
Thermal Shock Resistance	Excellent	Good	Good	Very Good	Excellent	Excellent
Break Resistance	Excellent	Good	Good	Very Good	Excellent	Good
Scratch Resistance	Very Good	Very Good	Very Good	Very Good	Very Good	Good
Stain Resistance	Very Good	Very Good	Very Good	Very Good	Very Good	Excellent
Heat Resistance	-40° to +99°C ‡	-10° to +82°C ‡	-10° to +80°C ‡	-40° to +190°C	-10° to +99°C ‡	-10° to +100°C ‡
Number of Sizes	11	1	7	1	2	14
Number of Shapes	12	1	5	1	2	2
Number of Colors	11***	7	7	1	2	6

* Stacking lugs allow free air circulation and perfect stacking

** Prorated warranty.

*** Not available for all tray styles.

‡ Not recommended for heated cart.

Materials Review

COMPARTMENT TRAYS

– Polycarbonate Trays

Made of highly durable, virtually unbreakable polycarbonate.

– ABS Trays

Made of high impact resistance and heat and chemical resistance ABS.

– Co-Polymer Trays

Made of economical pliable and break-resistant co-polymer.

– Heat resistant Trays

Made of heat resistant material. Oven (up to 190°C) and microwave safe. Ideal for heated carts or cook-chill process.

SERVICE TRAYS

– Polycarbonate Trays

Made of highly durable, virtually unbreakable polycarbonate.

DISPLAY TRAYS

– Market Trays

Made of high-impact resistant fiberglass that resists odors.

Personalization

Value Added Personalization

Promote business to customers and employees alike by placing your custom logo, trademark, slogan or design on our trays.

How to Order

- 1) Select a tray size, color, pattern, or design.
- 2) Provide complete, camera-ready artwork and indicate positioning on the tray.
- 3) According to the tray type, Cambro can produce 1, 2, 3 and 4 color artwork as well as 4 color process artwork.

We require the following:
a. Electronic artwork file provided on CD-ROM for Mac or PC.

We accept the following file formats:
• Adobe Illustrator, Adobe Photoshop file in JPEG, TIFF or EPS formats.

• File dimensions must equal 100% of reproduction size at 300dpi resolution.

b. Illustration on paper: The quality of the art must be crisp and scannable. Please specify PANTONE number for each color or indicate if it is a four color process.

4) An artist's fee of *** per hour will be charged to any order submitted

without complete, camera-ready artwork. Cambro will contact you if this fee will be charged and will give you an estimated cost.

5) Sample process:

a. For any new project, a finished sample will be submitted for the customer's approval.

b. The first sample with a firm purchase order is free. (Plus shipping cost.)

c. Samples not accompanied by a firm purchase order or requests for more than one sample will be charged a flat rate of:

– Polyester, Fiberglass and Laminated Trays:
*** Net per sample. (Plus shipping cost.)

– Polypropylene Fast Food Trays: *** Net per sample. (Plus shipping cost.)

d. Upon receipt and shipment of a firm purchase order, a credit will be applied to your account for the cost of one sample.

6) Personalization charges apply to both original orders and returns.

POLYESTER TRAYS

Versa Trays VT/GP (pages 188-189)

Versa Lite Trays VL/GL (pages 192-193)

- Only the following tray models are suitable for personalization:

Versa Trays:

VT1216, VT1418, VT2632, VT3253, VT3343, VT3343C, VT3646C, VT3753, VT3853, GP0540, GP1070, GP1080, GP3074, GP3980, GP4002, GP4210, GP4004, GP4701, GP4709, GP4853

Versalite Trays:

VL1014, VL1216, VL1418, VL2632, VL3253, VL3343, VL3343C, VL3646C, VL3753, GL0540, GL1070, GL1080, GL3074, GL3980, GL4002, GL4210, GL4701, GL4709

- **Minimum Quantity:** 120 trays per size.
- **Sample Production Time:** 10 business days + delivery and transit time from receipt of camera ready artwork.
- **Order Production Time:** Up to 4-6 weeks + delivery and transit time from the date artwork is approved and the order is confirmed.
- Request for additional samples without a firm purchase order will be charged *** Net per sample. (Plus shipping cost).

Printing Process Applicable:

Four Color Printing Process allows printing of one color or multiple color artwork as well as photo reproduction.

Tray Colors Recommended for Personalized Versa Trays VT/GP:

Speckled Mocha (A21), Sahara (A22), Light Grey (A27), Pearl White (A33), Terrazzo (A86).

For the following colors, please call Cambro Customer Service for artwork review: Magic Yellow (A25), Magic Mint (A26).

Tray Colors Recommended for Personalized Versa Lite Trays VL/GL:

Speckled Smoke (A20), Speckled Mocha (A21), Sahara (A22), Light Grey (A27), Pearl White (A33) and Terrazzo (A86).

Printable Area:

The artwork can cover the flat surface of tray up to 1 cm from the internal tray edge.

Personalization Charges Per Tray:

QUANTITY EACH	ADDITIONAL NET CHARGES
120-300	***
312-996	***
1,008 and up	***

*** Contact your Cambro representative for pricing



FIBERGLASS TRAYS

Camtray® Trays (pages 197-201)

- All Camtray sizes can be personalized. (Except compartment trays shown in main Cambro catalog).

Minimum Quantity:

Screen Printing Process: 144 trays per size.
Four Color Printing Process: 72 trays per size.

- **Sample Production Time:** 10 business days + delivery and transit time from receipt of camera ready artwork.
- **Order Production Time:** Up to 4-6 weeks + delivery and transit time from the date artwork is approved and the order is confirmed.
- Request for additional samples without a firm purchase order will be charged *** Net per sample. (Plus shipping cost).

Printing Process Applicable: Screen printing process and four color process.

a. Screen printing process allows printing of artwork with one or multiple colors laying next to each other. This process doesn't allow printing of gradient or photo reproduction. This process is best used with light color artwork on dark tray color.

Printable area: The artwork can cover the total surface of the tray from one edge to the other.

b. Four Color Printing Process allows printing of one color or multiple color artwork as well as photo reproduction. This process can only be used on light color trays. Darker tray color will make the artwork colors go darker.

Tray Colors Recommended for Four Color Printing Process:

Antique Parchment (101), Light Peach (106), Dark Peach (117), White (148), Sky Blue (177), Key Lime (429), Lemon Chiffon (536), Cameo Yellow (537), Cottage White (538).

Printable area: The artwork can cover the flat surface of tray up to 1 cm from the internal tray edge.

Personalization Charges Per Tray:

QUANTITY EACH	ADDITIONAL NET CHARGES
72*-144**	***
145-288	***
289-432	***
433 and up	Free

* Minimum quantity for four color printing process

** Minimum quantity for screen printing process

*** Contact your Cambro representative for pricing



1418

Personalization

LAMINATED TRAYS

Corfu (page 208) Capri (pages 209-210) Mykonos (page 211) Madeira (page 212)

- All Laminated tray sizes can be personalized or produced in any custom color. Custom color matching is treated as a personalization.
- Top and bottom parts of trays can be personalized with the exception of Corfu trays that can only be personalized on the backside of the tray. Personalization cost is per side of the tray.
- **Minimum Quantity:** 120 trays per size.



- **Sample Production Time:** 10 business days + delivery and transit time from receipt of camera ready artwork.
- **Order Production Time:** Up to 4-6 weeks + delivery and transit time from the date artwork is approved and the order is confirmed.

- Request for additional samples without a firm purchase order will be charged *** Net per sample. (Plus shipping cost.)

Printing Process Applicable: Four color process and Custom Color Matching

a. Four Color Printing Process: This process allows the printing of one color or multiple color artwork as well as photo reproduction.

b. Custom Color Matching: Custom color matching is treated as a personalization. To produce any color tray provide Cambro with PANTONE number.

Printable area: The artwork can cover the total surface of tray from one edge to the other. Artwork dimensions must be 4 cm bigger than tray sizes on each side due to trimming. (example: Tray size: 36 x 46 cm – Artwork size: 40 x 50 cm).

Personalization Charges Per Tray:

QUANTITY EACH	ADDITIONAL NET CHARGES
120-288	***
312-2,400	***
2,424 and up	***

*** Contact your Cambro representative for pricing

POLYPROPYLENE TRAYS

Fast Food Trays (page 213)

- All Fast Food tray sizes can be personalized except 1217FFH.
- **Minimum Quantity:** 288 trays per size.
- **Sample Production Time:** 10 business days + delivery and transit time from receipt of camera ready artwork.
- **Order Production Time:** Up to 4-6 weeks + delivery and transit time



from the date artwork is approved and the order is confirmed.

- Request for additional samples without a firm purchase order will be charged *** Net per sample. (Plus shipping cost.)

Printing Process Applicable:

Hot stamp 1 color process. Due to the application process onto textured tray surface, white can be selected but is not recommended.

Printable area: Artwork cannot exceed a maximum size of 15 x 15 cm.

Personalization Cost:

One-time die charge: *** Net per order.

Additional Net Charges Per Tray:

QUANTITY EACH	ADDITIONAL NET CHARGES
288-767	***
768-1,199	***
1,200-5,999	***
6,000-11,999	***
12,000 and up	***

*** Contact your Cambro representative for pricing.

CAMTREAD TRAYS

Tray Back Personalization and Rubber Surface Embossing

- **Camtread From USA:** Sizes Available: All Camtread sizes.
- **Camtread From Europe:** Sizes Available: 1100CT, 1400CT, 1600CT and 1800CT
- **Sample Production Time:** 10 business days + delivery and transit time from receipt of camera ready artwork.
- **Order Production Time:** Up to 4-6 weeks + delivery and transit time from the date artwork is approved and the order is confirmed.
- Request for additional samples without a firm purchase order will be charged *** Net per sample. (Plus shipping cost).



Tray Back Personalization Printing Process Applicable:

Four Color Printing Process allows printing of one color or multiple color artwork as well as photo reproduction.

Camtread From USA: White trays are recommended for tray back personalization.

Printable area: The artwork can cover the flat surface of tray up to 2,54 cm from the external tray edge.

Personalization Charges Per Tray:

QUANTITY EACH	ADDITIONAL NET CHARGES
Camtread From USA	
72-144	***
145-288	***
289-432	***
433 and up	Free
Camtread From Europe	
120-996	***
1,008 and up	***

Rubber Surface Embossing

- **Electronic File Format:** Adobe Illustrator EPS formats.

Embossing Process Printable Area:

The artwork can cover the surface of the tray up to 2,54 cm from the internal tray of edge.

Embossing Personalization Charge Per Tray:

QUANTITY EACH	ADDITIONAL NET CHARGES
Camtread From USA	
72 and up	***
Camtread From Europe	
156 and up	***

*** Contact your Cambro representative for pricing.

Polyester Versa Trays - Ecologic Series

SPECIFICATIONS

Material	Natural Material + Polyester
Surface Characteristic	Smooth
Performance	Excellent
Stacking Lugs	Yes
Dishwasher Safe	Yes – Extensive
Chemical Resistance	Excellent
Drying Test	Excellent
Shock Resistance	Excellent
Break Resistance	Excellent
Scratch Resistance	Excellent
Stain Resistance	Excellent
Heat Resistance	-40° to +140°C ‡



‡ Not for use in heated carts.

RECOMMENDED USE

- High Traffic / Frequent Use
- Hospitals
 - Schools
 - Universities
 - Canteens / Cafeterias / Self-Serve
 - Military

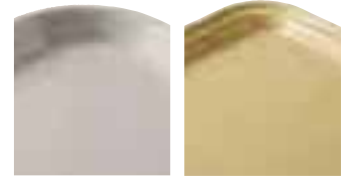

High Profile Shape Low Profile Shape



Low Profile Design Shape Flat Edge Shape



Made with resin derived from natural materials.



GPE4002

Average 20% lighter weight than the standard Versa Tray. Makes handling easy and convenient.



Personalization: Contact your Cambro representative for pricing.

High performance polyester tray with reinforced corners and edges for superior protection against impact.



Stacking lugs allow air circulation for fast drying and perfect stacking.

CODE	DIMENSIONS (CM)
Versa Trays – High Profile Shape	
VTE1418	35,5 x 45,7
VTE3343	33,0 x 43,0
Versa Trays – Low Profile Shape	
VTE3253	32,5 x 53,0
VTE3753	37,0 x 53,0
Versa Century™ – Low Profile Design Shape	
VTE3646C	35,5 x 45,7
Versa Trays – Flat Edge Shape	
GPE0540	46,0 x 34,4
GPE3980	53,0 x 37,0
GPE4002*	53,0 x 32,5
GPE4004**	53,0 x 32,5

Case Pack: 12 Minimum quantity order from CEL: 240 pieces.

* Designed with reinforced corners for automatic off-stacking onto conveyor belt dishwashers.

**Textured top surface to reduce sliding of dishes. Not available in (A72).

Tray Colors:

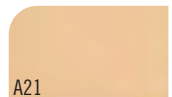

A21
Speckled Mocha

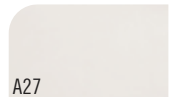

A27
Light Grey



A72
Charcoal

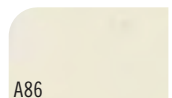

A86
Terrazzo

Polyester Versa Trays Plus

SPECIFICATIONS

Material	SMC – High Performance Fiberglass Reinforced Polyester
Surface Characteristic	Smooth
Performance	Excellent
Stacking Lugs	Yes
Dishwasher Safe	Yes – Extensive
Chemical Resistance	Excellent
Drying Test	Excellent
Shock Resistance	Excellent
Break Resistance	Excellent
Scratch Resistance	Excellent
Stain Resistance	Excellent
Heat Resistance	-40° to +140°C ‡



‡ Not for use in heated carts.

RECOMMENDED USE

High Traffic / Frequent Use

- Hospitals
- Schools
- Universities
- Canteens / Cafeterias / Self-Serve
- Military



High Profile Shape

Low Profile Shape



Low Profile Design Shape

Flat Edge Shape



GP4002

Easy Care

Dishwasher safe - wash as often and as frequently as needed.

stacking lugs allow air circulation for fast drying and perfect stacking.

5 year prorated warranty against breakage under normal application.

Long Lasting

Increased scratch resistance.

Proprietary material blend reduces scratch visibility.

Reinforced corners and edges protect and strengthen the tray.

S62

S60

Brick Red

S61

Black

Brown

CODE

DIMENSIONS (CM)

Versa Trays – High Profile Shape

VT1418 35,5 x 45,7

VT3343 33,0 x 43,0

Versa Trays – Low Profile Shape

VT2632 32,5 x 26,5

VT3253 32,5 x 53,0

VT3753 37,0 x 53,0

Versa Century™ – Low Profile Design Shape

VT3646C 35,5 x 45,7

Versa Trays – Flat Edge Shape

GP1070 32,5 x 26,5

GP3980 53,0 x 37,0

GP4002 53,0 x 32,5

Case Pack: 12

Minimum quantity order from CEL: 240 pieces.

Microban® Antibacterial Camguard® Versa Trays

SPECIFICATIONS

Material	SMC – High Performance Fiberglass Reinforced Polyester
Surface Characteristic	Smooth
Performance	Excellent
Stacking Lugs	Yes
Dishwasher Safe	Yes – Extensive
Chemical Resistance	Excellent
Drying Test	Excellent
Shock Resistance	Excellent
Break Resistance	Excellent
Scratch Resistance	Excellent
Stain Resistance	Excellent
Heat Resistance	-40° to +140°C‡



‡ Not for use in heated carts.

RECOMMENDED USE

High Traffic / Frequent Use
– Hospitals
– Schools
– Universities
– Canteens / Cafeterias / Self-Serve
– Military

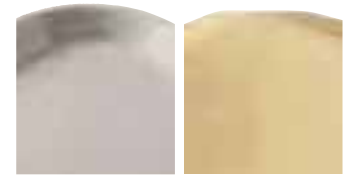

High Profile Shape

Low Profile Design Shape



Flat Edge Shape

CAMGUARD
ANTIBACTERIAL



Built-in Antimicrobial Protection from Microban Eliminates Bacteria

Microban 3G-Silver™ is built into every Cambro Camguard Versa Tray to protect against the harmful effects of bacteria. Microban eliminates existing bacteria and prevents the growth of new bacteria. This protection cannot be washed off and does not wear away over time. This built-in defense lasts for the life of the tray.



Unprotected Surface versus Microban 3G-Silver™ Treated Surface 24 Hour Test

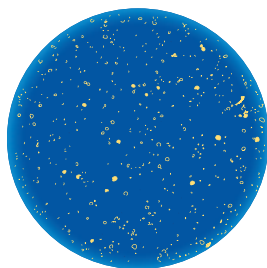

Untreated

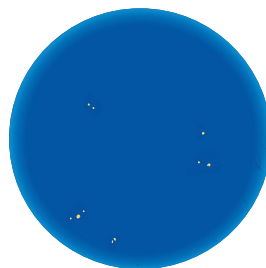

Treated with Microban®

CODE	DIMENSIONS (CM)
Versa Trays – High Profile Shape	
VT1418AB	35,5 x 45,7
VT3343AB	33,0 x 43,0
Versa Century™ Trays – Low Profile Design Shape	
VT3646CAB	35,5 x 45,7
VT3343CAB	32,9 x 43,0
Versa Trays – Flat Edge Shape	
GP1070AB*	32,5 x 26,5
GP1080AB*	37,0 x 26,5
GP3980AB*	53,0 x 37,0
GP4002AB*	53,0 x 32,5

Case Pack: 12

* Designed with reinforced corners for automatic off-stacking onto conveyor belt dishwashers.



Innovative low profile and low corner design increases space utilization of tray surface and customer comfort while eating.



Reinforced polyester corners provide superior corner and edge protection against impact.



Stacking lugs allow free air circulation for fast drying and perfect stacking.

Tray Color:

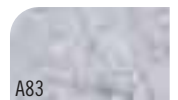

A83

Granite

Polyester Versa Trays with Smooth Surface

SPECIFICATIONS

Material	SMC – High Performance Fiberglass Reinforced Polyester
Surface Characteristic	Smooth
Performance	Excellent
Stacking Lugs	Yes
Dishwasher Safe	Yes – Extensive
Chemical Resistance	Excellent
Drying Test	Excellent
Shock Resistance	Excellent
Break Resistance	Excellent
Scratch Resistance	Excellent
Stain Resistance	Excellent
Heat Resistance*	-40° to +140°C ‡



‡ Not for use in heated carts.
Personalization, see page 183.
* Personalization Heat Resistance: 90°C.

RECOMMENDED USE

High Traffic / Frequent Use

- Hospitals
- Schools
- Universities
- Canteens / Cafeterias / Self-Serve
- Military

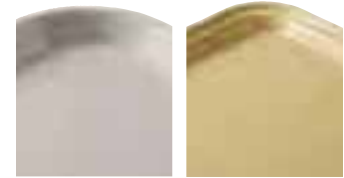

High Profile Shape Low Profile Shape



Low Profile Design Shape Flat Edge Shape

CODE	DIA/ SIZE (CM)	CASE PACK
Versa Trays – High Profile Shape		
VT1216	30,5 x 41,5	12
VT1418	35,5 x 45,7	12
<small>New!</small> VT1418TR - Trapezoid	35,5 x 45,7	12
<small>New!</small> VT1520	38,0 x 51,5	12
VT3343	33,0 x 43,0	12

Versa Trays – High Profile Shape



CODE	DIA/ SIZE (CM)	CASE PACK
Versa Trays – Low Profile Shape		
VT2632	32,5 x 26,5	12
VT3253	32,5 x 53,0	12
VT3753	37,0 x 53,0	12
VT3853	37,5 x 53,0	12

Versa Trays – Low Profile Shape

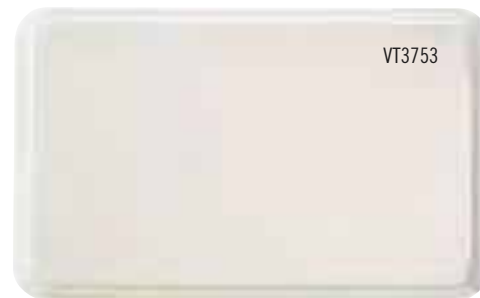

CODE	DIA/ SIZE (CM)	CASE PACK
Versa Century™ Trays – Low Profile Design Shape		
VT3646C	35,5 x 45,7	12
VT3343C	33,0 x 43,0	12

Versa Century Trays – Low Profile Design Shape



VT3646C

Innovative low profile and low corner design increases space utilization of tray surface and customer comfort while eating.

Polyester Versa Trays with Smooth Surface

CODE	DIA/ SIZE (CM)	CASE PACK
Versa Trays – Flat Edge Shape		
GP0540*	46,0 x 34,4	12
GP1070*	32,5 x 26,5	12
GP1080*	37,0 x 26,5	12
GP3074	45,0 x 32,0	12
GP3788	32,5 x 42,5	12
GP3980*	53,0 x 37,0	12
GP4002*	53,0 x 32,5	12
GP4004**	53,0 x 32,5	12
GP4701	42,5 x 32,5	12
GP4709	46,0 x 32,5	12
GP4856*	34,5 x 23,0	12

* Designed with reinforced corners for automatic off-stacking onto conveyor belt dishwashers.

**Textured top surface to reduce sliding of dishes. Not available in (A72).

Versa Trays – Flat Edge Shape



Tray Colors:

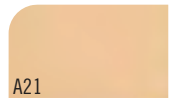

A21
Speckled Mocha

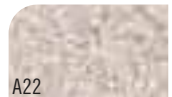

A22
Sahara

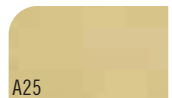

A25
Magic Yellow



A26
Magic Mint

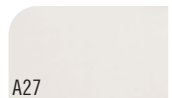

A27
Light Gray



A33
Pearl White

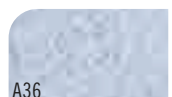

A36
Speckled Blue

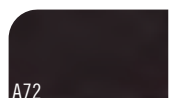

A72
Charcoal*



A83
Granite

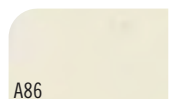

A86
Terrazzo

CODE	DIA/ SIZE (CM)	CASE PACK
Versa Trays – Café Trays		
GP55653	40,0 x 27,0	12
GP55702	26,0 x 20,0	12
GP55703	29,0 x 21,0	12

Versa Trays – Café Trays

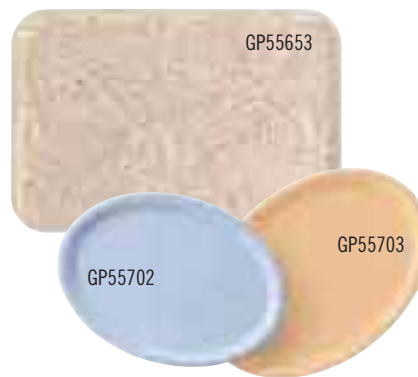

CODE	DIA/ SIZE (CM)	CASE PACK
Versa Trays – Space Saver Trays		
GP4210 - Trapezoid	48,0 x 34,0	12
GP4410 - Trapezoid	32,5 x 42,5	12
GP4853	42,4 x 32,5	12

Versa Trays – Space Saver Trays



Hexagonal table
Lateral side:
70 cm GP4210



Square table
80 x 80 cm
GP4210



Round table
Diam. 135 cm
GP4853



Square Table
95 x 95 cm
GP4853

Polyester Versa Trays VT/GP are not recommended for use in heated meal delivery carts. Please contact Cambro Customer Service or Presswerk Köngen GmbH, with any questions related to proper usage or any special application. Cambro will provide you with clear instructions on correct usage of our trays to ensure you get the maximum life out of our products.

*Charcoal color A72 will show scratches if not handled properly.

Polyester Decorated Versa Trays with Smooth Surface

SPECIFICATIONS

Material	SMC – High Performance Fiberglass Reinforced Polyester + Melamine Surface
Surface Characteristic	Smooth
Performance	Excellent
Stacking Lugs	Yes
Dishwasher Safe	Yes – Extensive
Chemical Resistance	Excellent*
Drying Test	Excellent
Shock Resistance	Excellent
Break Resistance	Excellent
Scratch Resistance	Excellent
Stain Resistance	Excellent
Heat Resistance	-40° to +90°C‡



‡ Not for use in heated carts.

* If you are using Thermo-Chemical Disinfection Equipment, please contact us. We will assist you finding the right tray for your application.

RECOMMENDED USE

- High Traffic / Frequent Use
- Hospitals
 - Schools
 - Universities
 - Canteens / Cafeterias / Self-Serve
 - Military



Flat Edge Shape



CODE	DIA/ SIZE (CM)	CASE PACK
Versa Trays – Flat Edge Shape		
GP0540*	46,0 x 34,4	12
GP3980*	53,0 x 37,0	12
GP4002*	53,0 x 32,5	12
GP4004	53,0 x 32,5	12

* Designed with reinforced corners for automatic off-stacking onto conveyor belt dishwashers.

Patterns and Tray Base Colors:



B98
Pebbled Grey on
Terrazzo Tray

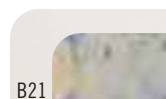

B21
Graffiti on
Light Grey Tray



B99
Pebbled Black on
Light Grey Tray



B33
Pearl White on
Pearl White Tray

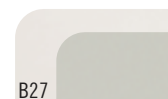

B27
Light Grey on
Light Grey Tray

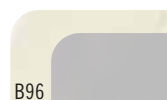

B96
Pebbled White on
Terrazzo Tray

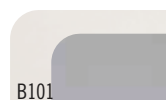

B101
Brushed Steel on
Light Grey Tray



B100
Pebbled Black on
Terrazzo Tray



B102
Brushed Steel on
Terrazzo Tray



B93
Titan on
Granite Tray

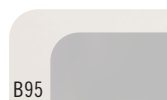

B95
Pebbled White on
Light Grey Tray

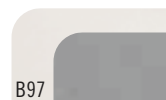

B97
Pebbled Grey on
Light Grey Tray



B26
Aqua on
Light Grey Tray

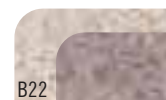

B22
Sahara on
Sahara Tray

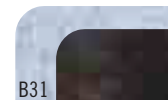

B31
Lava on
Speckled Blue Tray

Polyester Decorated Versa Trays with Non-Slip Surface

SPECIFICATIONS

Material	SMC – High Performance Fiberglass Reinforced Polyester + Non-Slip Surface
Surface Characteristic	Non-Slip
Performance	Excellent
Stacking Lugs	Yes
Dishwasher Safe	Yes - Extensive
Chemical Resistance	Good
Drying Test	Excellent
Shock Resistance	Excellent
Break Resistance	Excellent
Scratch Resistance	Good
Stain Resistance	Good
Heat Resistance	-40° to +80°C‡



PRORATED

‡ Not for use in heated carts.

Personalization: Contact your Cambro representative for pricing.

RECOMMENDED USE

- High Traffic / Frequent Use
- Hospitals
 - Schools
 - Universities
 - Canteens / Cafeterias / Self-Serve
 - Military



Flat Edge Shape

CODE	DIA/ SIZE (CM)	CASE PACK
Versa Trays – Flat Edge Shape		
GP3980NS*	53,0 x 37,0	12
GP4002NS*	53,0 x 32,5	12
GP0540NS*	46,0 x 34,4	12
GP1080NS*	37,0 x 26,5	12

*Designed with reinforced corners for automatic off-stacking onto conveyor belt dishwashers.



Patterns and Tray Base Colors:

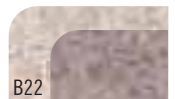

B22

Sahara on Sahara Tray



B93

Titan on Granite Tray



B31

Lava on Speckled Blue Tray



B99

Pebbled Black on Light Grey Tray



B100

Pebbled Black on Terrazzo Tray

Polyester Versa Lite Trays with Smooth Surface

SPECIFICATIONS

Material	SMC – Standard Performance Fiberglass Reinforced Polyester
Surface Characteristic	Smooth
Performance	Excellent
Stacking Lugs	Yes
Dishwasher Safe	Yes – Normal
Chemical Resistance	Good
Drying Test	Excellent
Shock Resistance	Good
Break Resistance	Good
Scratch Resistance	Good
Stain Resistance	Good
Heat Resistance*	-40° to +130°C‡



‡ Not for use in heated carts.
Personalization, see page 183.
* Personalization Heat Resistance: 90°C.

RECOMMENDED USE

Moderate Traffic / Economic Priority

- Schools
- Universities
- Canteens / Cafeterias / Self-Serve
- Military
- Hotel Room Service



High Profile Shape Low Profile Shape

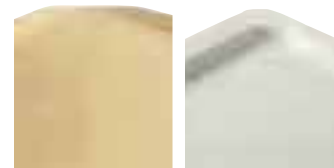

Low Profile Design Shape Flat Edge Shape



Low Profile Flat Edge Shape

CODE	DIA/ SIZE (CM)
Versa Lite Trays – Flat Edge Shape	
GL0540†	46,0 x 34,4
GL1070†	32,5 x 26,5
GL1080†	37,0 x 26,5
GL3074	45,0 x 32,0
GL3788	39,0 x 51,0
GL3980†	53,0 x 37,0
GL4002†	53,0 x 32,5
GL4060	40,0 x 60,0
GL4701	42,5 x 32,5
GL4709	46,0 x 32,5

Case Pack: 12

† Designed with reinforced corners for automatic off-stacking onto conveyor belt dishwashers.

Versa Lite Trays – Flat Edge Shape



GL4002



GL3788

GL4002

CODE	DIA/ SIZE (CM)
Versa Lite Trays – Space Saver Trays	
GL4210 - Trapezoid	48,0 x 34,0
GL4410 - Trapezoid	32,5 x 42,5

Case Pack: 12

Versa Lite Trays – Space Saver Trays

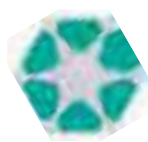

Hexagonal table
Lateral side:
70 cm GL4210



Square table
80 x 80 cm
GL4210



GL4210

GL4410

Polyester Versa Lite Trays with Smooth Surface

CODE	DIA/ SIZE (CM)
Versa Lite Trays – High Profile Shape	
VL1014	27,0 x 35,0
VL1216	30,5 x 41,5
VL3343	33,0 x 43,0
VL1418	35,5 x 45,7
<small>New!</small> VL1418TR - Trapezoid	35,5 x 45,7
<small>New!</small> VL1520	38,0 x 51,5

Case Pack: 12

Versa Lite Trays – High Profile Shape



VL1418

CODE	DIA/ SIZE (CM)
Versa Lite Trays – Low Profile Flat Edge Shape	
GL220P	32,5 x 53,0
GL210P	37,0 x 53,0

Case Pack: 12

Versa Lite Trays – Low Profile Flat Edge Shape



GL210P

GL220P

Tray Colors:

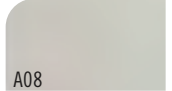

A08
Speckled Sand

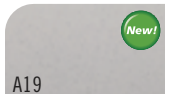

A19
Pebbled Grey



A20
Speckled Smoke



A21
Speckled Mocha



A22
Sahara



A27
Light Grey



A33
Pearl White



A83
Granite

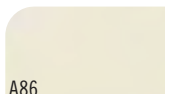

A86
Terrazzo

CODE	DIA/ SIZE (CM)
Versa Lite Trays – Low Profile Shape	
VL2632	32,5 x 26,5
VL3253	32,5 x 53,0
VL3753	37,0 x 53,0

Case Pack: 12

Versa Lite Trays – Low Profile Shape

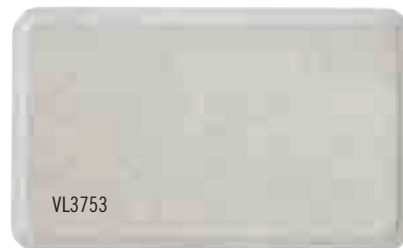

VL3753

CODE	DIA/ SIZE (CM)
Versa Lite Century™ Trays – Low Profile Design Shape	
VL3646C	35,5 x 45,7
VL3343C	33,0 x 43,0

Case Pack: 12

Versa Lite Century Trays – Low Profile Design Shape



VL3646C

Innovative low profile and low corner design increases space utilization of tray surface and customer comfort while eating.

Century Fun Trays – Create a vibrant table top with colourful trays

SPECIFICATIONS

	Versa Tray	Versa Lite Tray
Material	SMC – High Performance Fiberglass Reinforced Polyester	SMC – Standard Performance Fiberglass Reinforced Polyester
Surface Characteristic	Smooth	Smooth
Performance	Excellent	Excellent
Stacking Lugs	Yes	Yes
Dishwasher Safe	Yes – Extensive	Yes – Normal
Chemical Resistance	Excellent	Good
Drying Test	Excellent	Excellent
Shock Resistance	Excellent	Good
Break Resistance	Excellent	Good
Scratch Resistance	Excellent	Good
Stain Resistance	Excellent	Good
Heat Resistance*	-40° to +140°C‡	-40° to +130°C‡

‡ Not for use in heated carts.
Personalization, see page 183.

* Personalization Heat Resistance: 90°C.

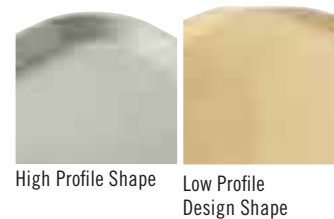

High Profile Shape

Low Profile Design Shape

RECOMMENDED USE

High Traffic / Frequent Use

- Hospitals
- Schools
- Universities
- Canteens / Cafeterias / Self-Serve
- Military



VT3646C



Reinforced polyester corners provide superior corner and edge protection against impact.

Stacking lugs allow air circulation for fast drying and perfect stacking.

Innovative low profile and low corner design increases space utilization of tray surface and customer comfort while eating.

Personalization

Possibility to personalize to any PMS colors of your choice.

Minimum quantity: 120 pieces.

Please refer to personalization procedure and color availability in the Personalization section.

For assistance please contact your Cambro representative.

Century Fun Trays are made for intensive use. Scratch, stain, chemical and break-resistant, Century Fun trays are available in 5 contemporary colours on a pure white tray. Match the tray colour to your décor (dishes, furniture, walls, etc.).



F01 Sage on White Tray

F02 Raspberry on White Tray

F03 Grape on White Tray

F04 Pearl Grey on White Tray

F05 Dark Peach on White Tray

CODE	DIMENSIONS (CM)	CASE PACK
Versa Trays		
VT1418	35,5 x 45,7	12
VT3646C	35,5 x 45,7	12
Versa Lite Trays		
VL1418	35,5 x 45,7	12
VL3646C	35,5 x 45,7	12

Non-Skid Versa Lite Trays

SPECIFICATIONS

Material	SMC – Standard Performance Fiberglass Reinforced Polyester
Surface Characteristic	Smooth
Performance	Excellent
Stacking Lugs	Yes
Dishwasher Safe	Yes – Normal
Chemical Resistance	Good
Drying Test	Excellent
Shock Resistance	Good
Break Resistance	Good
Scratch Resistance	Good
Stain Resistance	Good
Heat Resistance*	-40° to +130°C‡



‡ Not for use in heated carts.
Personalization: Contact your
Cambro representative for pricing.
* Personalization Heat Resistance: 90°C.



CODE	DIA/ SIZE (CM)
Versa Lite Trays – High Profile Shape	
VL1418NS	35,5 x 45,7
VL3343NS	33,0 x 43,0
Versa Lite Century™ Trays – Low Profile Design Shape	
VL3646CNS	35,5 x 45,7
VL3343CNS	33,0 x 43,0
Versa Lite Trays – Flat Edge Shape	
GL3980NS*	53,0 x 37,0
GL4002NS*	53,0 x 32,5

Case Pack: 12.

* Designed with reinforced corners for automatic off-stacking onto conveyor belt dishwashers.

RECOMMENDED USE

- Intensive Use / Economic Priority
- Hospitals
- Schools
- Universities
- Canteens / Cafeterias / Self-Serve
- Military
- Catering / Cruise Ships
- Hotels / Room Service

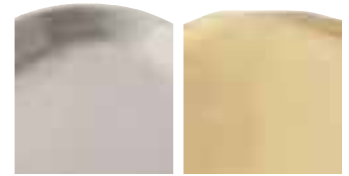

High Profile Shape

Low Profile Design Shape



Flat Edge Shape



Reinforced polyester corners provide superior corner and edge protection against impact.



Stacking lugs allow free air circulation for fast drying and perfect stacking.



Versa Lite Century Trays have low edges and ergonomic corners that enhance comfort.

Tray Colors:

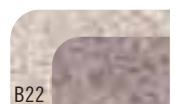

B22
Sahara on Sahara Tray



B14
Titan on Speckled Smoke Tray



B11
Sahara on Pearl White Tray

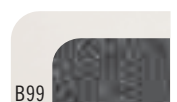

B99
Pebbled Black on Light Grey Tray



Non-Skid Trays grip firmly providing safer meal delivery service.

Polyester Versa Lite Trays with Non-Slip Rubber Surface

SPECIFICATIONS

Material	SMC – Standard Performance Fiberglass Reinforced Polyester + Non-Slip Rubber
Surface Characteristic	Non-Slip Rubber
Performance	Excellent
Stacking Lugs	Yes
Dishwasher Safe	Yes – Normal
Chemical Resistance	Good
Drying Test	Excellent
Shock Resistance	Good
Break Resistance	Good
Scratch Resistance	Good
Stain Resistance	Good
Heat Resistance	-40° to +100°C‡



‡ Not recommended for heated carts.

RECOMMENDED USE

Moderate Traffic / Economic Priority

- Banquet Service
- Restaurant / Cafes
- Bars / Clubs / Pubs
- Catering
- Brasseries

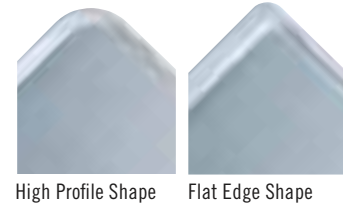

CODE	DIA/ SIZE (CM)	CASE PACK
Versa Lite Trays – High Profile Shape		
VL1418RNS	35,5 x 45,7	12
Versa Lite Trays – Flat Edge Shape		
GL1070RNS*	32,5 x 26,5	12
GL4002RNS*	53,0 x 32,5	12
GL3980RNS*	53,0 x 37,0	12
Versa Lite Tray – Cafe Trays		
VL2129RNS	21,0 x 29,0	12
VL3200RNS	ø 32,0	12
VL3600RNS	ø 36,0	12



Patterns and Tray Base Colors:

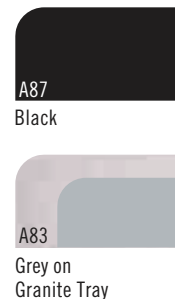

*Designed with reinforced corners for automatic off-stacking onto conveyor belt dishwashers.

Camtrays® Fiberglass Trays with Smooth Surface

SPECIFICATIONS

Material	Fiberglass Layers + Polyester Resin
Surface Characteristic	Smooth
Performance	Excellent
Stacking Lugs	Yes
Dishwasher Safe	Yes – Extensive
Chemical Resistance	Good
Drying Test	Excellent
Shock Resistance	Excellent
Break Resistance	Excellent
Scratch Resistance	Excellent
Stain Resistance	Excellent
Heat Resistance	-10° to +100°C‡

‡ Not for use in heated carts.
Personalization, see page 183.

RECOMMENDED USE

High Traffic / Frequent Use

- Hospitals
- Schools
- Universities
- Canteens / Cafeterias / Self-Serve
- Military
- Hotel Room Service

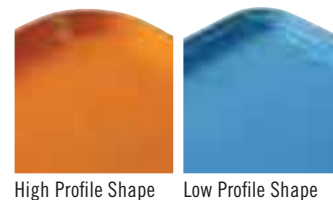

High Profile Shape

Low Profile Shape

† Available in Group I colors and patterns and Group III patterns.

Δ Available in Group I colors and patterns except Doily.

* Special order item not carried in stock – non-returnable.

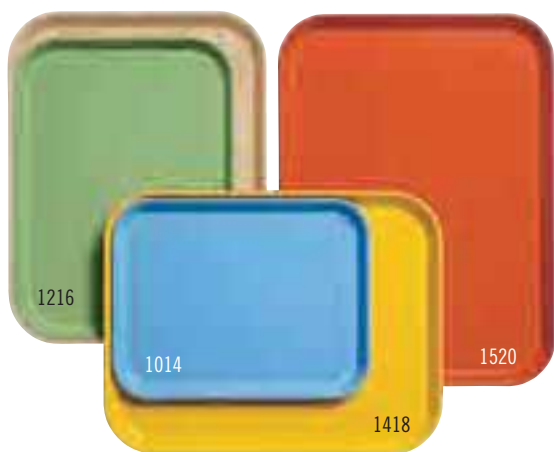
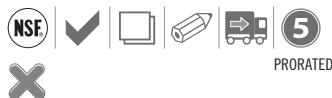

CODE	DIA/ SIZE (CM)	CASE PACK
Rectangular – High Profile Shape		
810†	20,5 x 25	12
915†	22 x 38	12
926*†	22,5 x 65 x 2,5	12
1014†	27 x 35	12
1015*Δ	26 x 38	24
1116*Δ	27,5 x 40,5	24
1216†	30,5 x 41,5	12
1313†	33 x 33	12
1318*†	32 x 45 x 3	12
1418†	35,5 x 45,7	12
1520†	38 x 51,5	12
1622†	40,5 x 56	12
16225*†	42 x 57	12
1826†	45,5 x 65,5	6
Rectangular – Low Profile Shape		
46†	11 x 15	12
57*†	12,5 x 18	12
2025*†	53 x 65	6



Camtrays® Fiberglass Trays with Smooth Surface

SPECIFICATIONS

Material	Fiberglass Layers + Polyester Resin
Surface Characteristic	Smooth
Performance	Excellent
Stacking Lugs	Yes
Dishwasher Safe	Yes – Extensive
Chemical Resistance	Good
Drying Test	Excellent
Shock Resistance	Excellent
Break Resistance	Excellent
Scratch Resistance	Excellent
Stain Resistance	Excellent
Heat Resistance	-10° to +100°C‡

‡ Not for use in heated carts.

RECOMMENDED USE

- High Traffic / Frequent Use
- Hospitals
 - Schools
 - Universities
 - Canteens / Cafeterias / Self-Serve
 - Military
 - Hotel Room Service

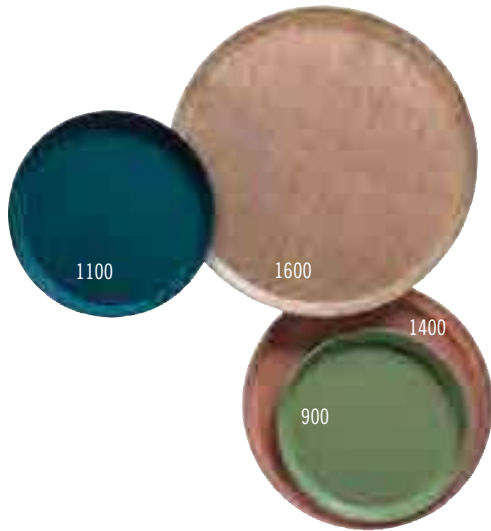
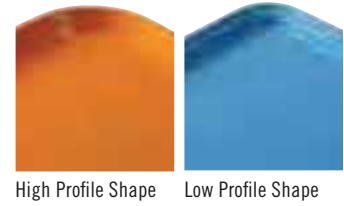

CODE	DIA/ SIZE (CM)	CASE PACK
Trapezoid – High Profile Shape		
1418TR*†	35,5 x 45,7	12
1422TR*†	35,5 x 56	12
Trapezoid – Low Profile Shape		
1520TR*†	37 x 49,5	12
Oval – Low Profile Shape		
2500*Δ	49 x 61	6
2700*Δ	56 x 68,5	6
Round – High Profile Shape		
900*Δ	∅ 23	12
1000*Δ	∅ 25,5	12
1100Δ	∅ 28	12
1200*Δ	∅ 30,5	12
1300*Δ	∅ 33	12
1400Δ	∅ 35,5	12
1600Δ	∅ 40,5	12
Round – Low Profile Shape		
1550*Δ	∅ 40,5	12
1950*Δ	∅ 49,5	12

† Available in Group I colors and patterns and Group III patterns.

Δ Available in Group I colors and patterns except Doily.

* Special order item not carried in stock – non-returnable.



Personalization, see page 183.

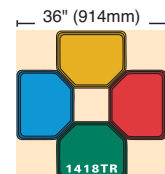
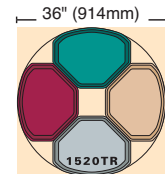
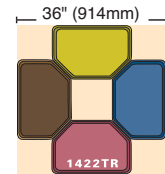

Camtrays® Fiberglass Trays with Smooth Surface

SPECIFICATIONS

Material	Fiberglass Layers + Polyester Resin
Surface Characteristic	Smooth
Performance	Excellent
Stacking Lugs	Yes
Dishwasher Safe	Yes – Extensive
Chemical Resistance	Good
Drying Test	Excellent
Shock Resistance	Excellent
Break Resistance	Excellent
Scratch Resistance	Excellent
Stain Resistance	Excellent
Heat Resistance	-10° to +100°C‡

* Special order item not carried in stock – non-returnable.

◇ Available in Group I colors and patterns and Group III Patterns.



‡ Not for use in heated carts.
Personalization, see page 183.

RECOMMENDED USE

- High Traffic / Frequent Use
- Hospitals
 - Schools
 - Universities
 - Canteens / Cafeterias / Self-Serve
 - Military
 - Hotel Room Service

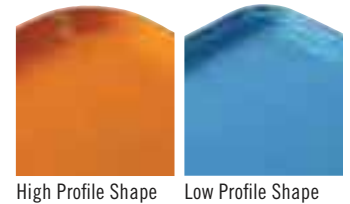

High Profile Shape Low Profile Shape



CODE	DIA/ SIZE (CM)	CASE PACK
Metric Rectangular – High Profile Shape		
1313◇	33 x 33	12
3242◇	31,9 x 41,9	12
3853*◇	37,5 x 53	12
Metric Rectangular – Low Profile Shape		
2632*◇	26,5 x 32,5	12
3046*◇	30 x 46	12
3253*◇	32,5 x 53	12
3343◇	33 x 43	12
3753*◇	37 x 53	12

Camtray® Group I Colors

Colors listed alphabetically. See numerical reference on following page.



123

Amazon Blue



101

Antique Parchment



513

Bay Leaf Brown



110

Black



409

Blush



116

Brazil Brown



522

Burgundy Wine



521

Cambro Red



537

Cameo Yellow



505

Cherry Red



220

Citrus Orange



538

Cottage White



117

Dark Peach



104

Desert Tan



514

Earthen Gold



221

Ever Red



551

Grape



105

Horizon Blue



429

Key Lime



536

Lemon Chiffon



106

Light Peach



113

Lime-ade



504

Mustard



428

Olive Green



222

Orange Pizazz



107

Pearl Grey



410

Raspberry Cream



501

Real Rust



518

Robin Egg Blue



119

Sherwood Green



510

Signal Red



177

Sky Blue



401

Slate Blue



508

Suede Brown



199

Taupe



414

Teal



171

Tuscan Gold



148

White

Due to the catalog printing process, the colors & patterns shown may not be exact.
Contact Cambro or a Cambro representative for a color chip.

Camtray® Group I Patterns

Galaxy

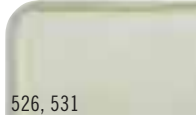

526, 531
Antique Parchment
(526 Gold), (531 Silver)

Swirl



270
Black & Gold NR



277
Grey NR

Doily



241
Antique Parchment NR



246
Light Peach NR

Decorator

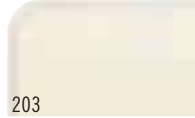

203
Grass Mat NR

Abstract



214
Tan NR

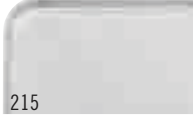

215
Grey NR

NR Trays are non-returnable.



Camtray Group III - Wood

Wood



308
Burma Teak NR



304
Country Oak NR



301
Dark Basketweave NR



309
Java Teak NR

Linen



329
Toffee NR



302
Light Basketweave NR



303
Light Butcher Block NR



307
Light Elm NR



204
Rattan NR

NR Trays are non-returnable.

Camtray Group I Colors – Numerical Reference by Color Code

Antique Parchment (101),
Desert Tan (104), Horizon Blue (105),
Light Peach (106), Pearl Grey (107),
Black (110), Lime-ade (113),
Brazil Brown (116), Dark Peach (117),
Sherwood Green (119),
Amazon Blue (123), White (148),

Tuscan Gold (171), Sky Blue (177),
Taupe (199), Citrus Orange (220),
Ever Red (221) Orange Pizazz (222),
Slate Blue (401), Blush (409),
Raspberry Cream (410),
Teal (414), Olive Green (428),
Key Lime (429), Real Rust (501),

Mustard (504), Cherry Red (505),
Suede Brown (508), Signal Red (510),
Bayleaf Brown (513),
Earthen Gold (514),
Robin Egg Blue (518),
Cambro Red (521),
Burgundy Wine (522),

Lemon Chiffon (536),
Cameo Yellow (537),
Cottage White (538), Grape (551).

**Due to the catalog printing process, the colors & patterns shown may not be exact.
Contact Cambro or a Cambro representative for a color chip.**

Non-Skid Versa Camtrays®

SPECIFICATIONS

Material	Fiberglass Layers + Polyester Resin + Non-Slip Surface
Surface Characteristic	Non-Slip
Performance	Excellent
Stacking Lugs	Yes
Dishwasher Safe	Yes - Extensive
Chemical Resistance	Good
Drying Test	Excellent
Shock Resistance	Excellent
Break Resistance	Excellent
Scratch Resistance	Good
Stain Resistance	Good
Heat Resistance	-40° to +80°C‡

Non-Skid Versa Camtrays for Room Service is covered by U.S. Patent D 683,191 S. ‡ Not recommended for heated carts. Personalization: Contact your Cambro representative for pricing.



RECOMMENDED USE

Moderate Traffic / Economic Priority

- Schools
- Universities
- Canteens / Cafeterias / Self-Serve
- Military
- Hotel Room Service



High Profile Shape Low Profile Shape



Low Design Profile Shape

CODE	DIA/ SIZE (CM)
------	-------------------

Non-Skid Versa Camtray – High Profile Shape

1418VC	36,0 x 46,0
1520VC	38,0 x 51,0

Case Pack: 12



Non-skid trays grip firmly.

CODE	DIA/ SIZE (CM)
------	-------------------

Non-Skid Versa Dietary Tray – Low Profile Shape

1520VDC*	38,0 x 51,0
----------	-------------

Case Pack: 12

*Available in Black with Pebbled Black (382).



CODE	DIA/ SIZE (CM)
------	-------------------

Non-Skid Versa Century Camtray – Low Design Profile Shape

1418VCC	36,0 x 46,0
1520VCC	38,0 x 51,0

Case Pack: 12



CODE	DIA/ SIZE (CM)
------	-------------------

Room Service Non-Skid Camtray – Low Profile Shape

1520VCRST	38,0 x 51,0
-----------	-------------

Case Pack: 12



Tray Colors:



380
Ivory with Sahara



381
Pearl Gray with Titan



382
Black with Pebbled Black

Dietary Trays

SPECIFICATIONS

Material	Fiberglass Layers + Polyester Resin
Surface Characteristic	Smooth
Performance	Excellent
Stacking Lugs	Yes
Dishwasher Safe	Yes – Extensive
Chemical Resistance	Good
Drying Test	Excellent
Shock Resistance	Excellent
Break Resistance	Good
Scratch Resistance	Good
Stain Resistance	Excellent
Heat Resistance	-10° to +100°C‡

‡ Not for use in heated carts..

RECOMMENDED USE

High Traffic / Frequent Use

- Hospitals
- Schools
- Universities
- Canteens / Cafeterias / Self-Serve
- Military
- Hotel Room Service

Available in Group I colors and patterns and Group III Patterns.

Dietary Trays are guaranteed for one year against breakage.

* Special order item not carried in stock – non-returnable.



Low Profile Shape



CODE	DIA/ SIZE (CM)	CASE PACK
Dietary Trays – Low Profile Shape		
1216D*	30,5 x 41,5	12
1219D*	30,5 x 48,3	12
1220D*	30,5 x 51	12
1222D*	30,5 x 56	12
1418D*	35,5 x 46	12
1520D*	38,0 x 51,3	12
1622D*	40,3 x 55,6	12

Camlite® Trays

SPECIFICATIONS

Material	Fiberglass Layers + Polyester Resin
Surface Characteristic	Smooth
Performance	Excellent
Stacking Lugs	Yes
Dishwasher Safe	Yes – Extensive
Chemical Resistance	Good
Drying Test	Excellent
Shock Resistance	Excellent
Break Resistance	Good
Scratch Resistance	Good
Stain Resistance	Excellent
Heat Resistance	-10° to +100°C‡

‡ Not for use in heated carts.

RECOMMENDED USE

High Traffic / Frequent Use

- Hospitals
- Schools
- Universities
- Canteens / Cafeterias / Self-Serve
- Military
- Hotel Room Service

Colors: Rose Red (163), Yellow (145), Green (162), Blue (142), Tan (161), Steel White (676), Steel Red (675), Steel Blue (674), Black (110).

12 dozen minimum order required for any special color orders.

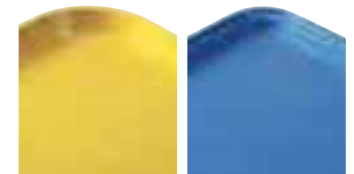

High Profile Shape Low Profile Shape



CODE	DIA/ SIZE (CM)	CASE PACK
Rectangular Camlite Trays – High Profile Shape		
1014CL	27 x 35	12
1216CL	30,5 x 41,5	12
1418CL	36 x 46	12
1520CL	38 x 51,5	12
1826CL	45,5 x 65,5	12
Rectangular Camlite Trays – Low Profile Shape		
3253CL	32,5 x 53	12
3753CL	37 x 53	12

Camtread® Fiberglass Trays with Non-Slip Rubber Surface

SPECIFICATIONS

Material	Fiberglass Layers + Polyester Resin + Non-Slip Rubber Surface Molded From Edge-To-Edge
Surface Characteristic	Non-Slip Rubber
Performance	Excellent
Stacking Lugs	Yes
Dishwasher Safe	Yes – Extensive
Chemical Resistance	Good
Drying Test	Excellent
Shock Resistance	Excellent
Break Resistance	Good
Scratch Resistance	Excellent
Stain Resistance	Good
Heat Resistance	-10° to +100°C‡

‡ Not for use in heated carts.

RECOMMENDED USE

High Traffic / Frequent Use
– Banquet Service
– Restaurants / Cafes
– Bars / Clubs / Pubs
– Catering
– Brasseries



High Profile Shape Low Profile Shape



Low Profile Shape Oval



CODE	DIA/ SIZE (CM)	CASE PACK
Round – High Profile Shape		
900CT*	∅ 23	12
1100CT	∅ 28	12
1400CT	∅ 35,5	12
1600CT	∅ 40,5	12
1800CT	∅ 45	6
Round – Low Profile Shape		
1550CT*	∅ 40,5	12
1950CT*	∅ 49,5	12
Oval – Low Profile Shap		
2500CT	49 x 59	6
2700CT	56 x 68,5	6
2900CT	73,5 x 60	6
Rectangular – High Profile Shape		
1014CT*	27 x 35	12
1216CT*	30,5 x 41,5	12
1418CT	36 x 46	12
1520CT*	38 x 51,5	12
1622CT	40,5 x 56	12
1826CT	45 x 65	6
Rectangular – Low Profile Shape		
3253CT	32,5 x 53	12

Orders for non-standard Camtread Tray colors will be handled by special quotation only.

* Special order item not carried in stock – non-returnable.

Do not use Camtread Trays in enclosed heated carts.



Personalization, see page 184.



Tray Colors:

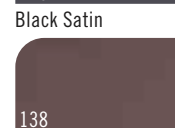
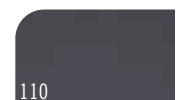

Treadlite™ Trays

SPECIFICATIONS

Material	Fiberglass Layers + Polyester Resin + Non-Slip Rubber Surface
Surface Characteristic	Non-Slip Rubber Surface
Performance	Good
Stacking Lugs	Yes
Dishwasher Safe	Yes – Minimal
Chemical Resistance	Good
Drying Test	Good
Shock Resistance	Good
Break Resistance	Good
Scratch Resistance	Good
Stain Resistance	Good
Heat Resistance	-10° to +80°C‡



‡ Not for use in heated carts.

RECOMMENDED USE

Moderate Traffic / Economic Priority

- Brasseries
- Restaurants / Cafes
- Bars / Clubs / Pubs



New!



Tray Colors:



110
Black Satin



138
Tavern Tan

CODE	DIA/ SIZE (CM)	CASE PACK
1400TL	ø 35,5	12
1600TL	ø 40,5	12

Polytread® Trays

SPECIFICATIONS

Material	Polypropylene + Non-Slip Rubber Surface
Surface Characteristic	Non-Slip Rubber Surface
Performance	Good
Stacking Lugs	Yes
Dishwasher Safe	Yes – Minimal
Chemical Resistance	Good
Drying Test	Good
Shock Resistance	Good
Break Resistance	Good
Scratch Resistance	Good
Stain Resistance	Good
Heat Resistance	-10° to +80°C‡



‡ Not for use in heated carts.

RECOMMENDED USE

Moderate Traffic / Economic Priority

- Brasseries
- Restaurants / Cafes
- Bars / Clubs / Pubs



High Profile Shape



Tray Colors:



110
Black



167
Brown

CODE	DIA/ SIZE (CM)	CASE PACK
Round – High Profile Shape		
PT1100	ø 28	12
PT1400	ø 35,5	12
PT1600	ø 40,5	12
Rectangular – High Profile Shape		
PT1014	27 x 34,5	24
PT1216	30 x 41,5	24
PT1418	36 x 46	12

Beechwood Trays with Smooth Surface

SPECIFICATIONS

Material	Beechwood Veneer
Surface Characteristic	Smooth
Performance	Good
Stacking Lugs	No
Dishwasher Safe	Yes – Normal
Chemical Resistance	Good
Drying Test	Good
Shock Resistance	Good
Break Resistance	Good
Scratch Resistance	Good
Stain Resistance	Good
Heat Resistance	-10° to +100°C‡



‡ Not for use in heated carts.

Beechwood Trays with Non-Slip Surface

SPECIFICATIONS

Material	Beechwood Veneer
Surface Characteristic	Non-Slip Surface
Performance	Good
Stacking Lugs	No
Dishwasher Safe	Yes – Minimal
Chemical Resistance	Good
Drying Test	Good
Shock Resistance	Good
Break Resistance	Good
Scratch Resistance	Good
Stain Resistance	Good
Heat Resistance	-10° to +100°C‡



‡ Not for use in heated carts.



RECOMMENDED USE

Mild Use / Emphasis on style with limited washing

- Banquet Service
- Restaurants / Cafes
- Catering



Tray Color:



000
Beechwood

CODE	DIA/ SIZE (CM)	CASE PACK
Rectangular – 60 Series		
PH556010	45,0 x 32,0	12
PH556020	58,0 x 38,0	12
PH556030	63,0 x 40,0	12
PH556040	70,0 x 45,0	12
PH556050	75,0 x 48,0	12
Rectangular – 65 Series		
PH556510	27,0 x 20,0	12
PH556520	33,0 x 23,0	12
Oval		
PH557010	23,0 x 16,0	24
PH557020	26,0 x 20,0	24
PH557030	29,0 x 21,0	24
PH557040	33,0 x 24,0	24
Round Beer Tray		
PH558510	ø 32,0	12
PH558520	ø 36,0	12
PH558530	ø 42,0	12

RECOMMENDED USE

Mild Use / Emphasis on style with limited washing

- Banquet Service
- Restaurants / Cafes
- Bars / Clubs / Pubs
- Catering
- Brasseries



Tray Color:



000
Beechwood

CODE	DIA/ SIZE (CM)	CASE PACK
Rectangular – 60 Series		
PH556016	45,0 x 32,0	12
PH556026	58,0 x 38,0	12
PH556036	63,0 x 40,0	12
PH556046	70,0 x 45,0	12
PH556056	75,0 x 48,0	12
Rectangular – 65 Series		
PH556516	27,0 x 20,0	12
PH556526	33,0 x 23,0	12
Oval		
PH557016	23,0 x 16,0	24
PH557026	26,0 x 20,0	24
PH557036	29,0 x 21,0	24
PH557046	33,0 x 24,0	24
Round Beer Tray		
PH558516	ø 32,0	12
PH558526	ø 36,0	12
PH558536	ø 42,0	12

Mahogany Wood Trays with Non-Slip Surface

SPECIFICATIONS

Material	Mahogany Veneer
Surface Characteristic	Non-Slip Surface
Performance	Good
Stacking Lugs	No
Dishwasher Safe	Yes – Minimal
Chemical Resistance	Good
Drying Test	Good
Shock Resistance	Good
Break Resistance	Good
Scratch Resistance	Good
Stain Resistance	Good
Heat Resistance	-10° to +100°C‡



‡ Not for use in heated carts.

RECOMMENDED USE

Mild Use / Emphasis on style with limited washing

- Banquet Service
- Restaurants / Cafes
- Bars / Clubs / Pubs
- Catering
- Brasseries

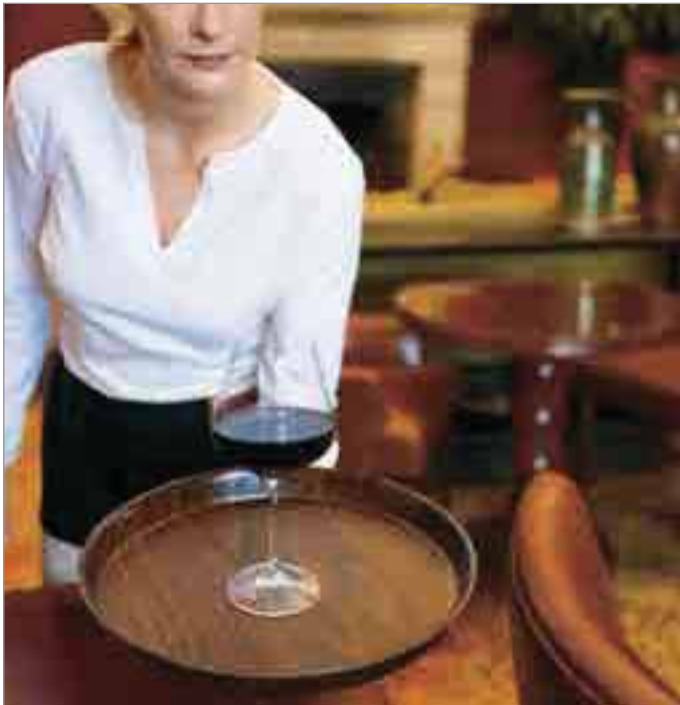

CODE	DIA/ SIZE (CM)	CASE PACK
Rectangular		
MW3245	32,0 x 45,0	12
MW3858	37,5 x 57,5	12
MW3646	36,0 x 46,0	12
Oval		
MW2129	21,0 x 29,0	12
Round Beer Tray		
MW3200	∅ 32,0	12
MW3600	∅ 36,0	12
MW4200	∅ 42,0	12

Tray Color:

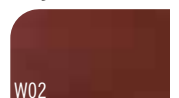

W02
Mahogany

ENG MET CS / Trays

Corfu – Laminated Trays with Non-Slip Rubber Surface

SPECIFICATIONS

Material	Laminate + Non-Slip Rubber Surface
Surface Characteristic	Non-Slip Rubber Surface
Performance	Excellent
Stacking Lugs	No
Dishwasher Safe	Yes – Normal
Chemical Resistance	Excellent
Drying Test	Good
Shock Resistance	Good
Break Resistance	Good
Scratch Resistance	Good
Stain Resistance	Good
Heat Resistance	-10° to +100°C‡



Personalization,
see page 184.

‡ Not for use in heated carts.

Note: All laminated trays must be dried
before stacking.

RECOMMENDED USE

Normal Use / Emphasis on style
with limited washing

- Canteens / Cafeterias / Self-Serve
- Banquet Service
- Restaurants / Cafes
- Bars / Clubs / Pubs
- Catering



CODE	DIA/ SIZE (CM)	CASE PACK
Rectangular		
C02632	26,5 x 32,5	12
C03253	32,5 x 53,0	12
C03343	33,0 x 43,0	12
C03646	36,0 x 46,0	12
C03753	37,0 x 53,0	12
Round		
C03200	ø 32,0	12
C03800	ø 38,0	12
C04300	ø 43,0	12



Tray Colors:



D01
Black on Grey



D02
Brown

Mykonos – Laminated Trays with Non-Slip Surface

SPECIFICATIONS

Material	Laminate + Non-Slip Surface
Surface Characteristics	Non-Slip Surface
Performance	Good
Stacking Lugs	No
Dishwasher Safe	Yes – Minimal
Chemical Resistance	Good
Drying Test	Good
Shock Resistance	Good
Break Resistance	Good
Scratch Resistance	Good
Stain Resistance	Good*
Heat Resistance	-10° to +100°C‡

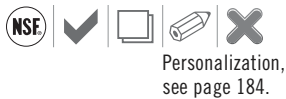

‡ Not for use in heated carts.

Note: All laminated trays must be dried before stacking.

*Limited stain resistance for Birch (E75)

RECOMMENDED USE

Moderate Use / Emphasis on Style with Limited Washing

- Banquet Services
- Restaurants / Cafes
- Bars / Clubs / Pubs
- Catering



Tray Colors:

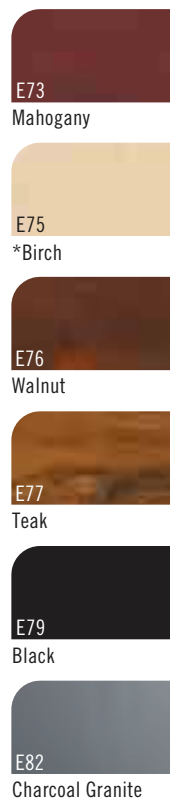

CODE	DIA/ SIZE (CM)	CASE PACK
Rectangular		
MY2632	26,5 x 32,5	24
MY2738	27,0 x 38,0	24
MY3244	32,0 x 44,0	24
MY3253	32,5 x 53,0	24
MY3343	33,0 x 43,0	24
MY3446	34,0 x 46,0	24
MY3646	36,0 x 46,0	24
MY3753	37,0 x 53,0	24
MY3952	39,0 x 52,0	24
MY4361	43,0 x 61,0	12
Oval		
MY2026	20,0 x 26,5	24
MY2129	21,0 x 29,0	24
Round		
MY3200	∅ 32,0	24
MY3800	∅ 38,0	24
MY4300	∅ 43,0	24

Capri – Laminated Trays with Smooth Surface

SPECIFICATIONS

Material	Laminate
Surface Characteristic	Smooth
Performance	Good
Stacking Lugs	No
Dishwasher Safe	Yes – Normal
Chemical Resistance	Excellent
Drying Test	Good
Shock Resistance	Good
Break Resistance	Good
Scratch Resistance	Good
Stain Resistance	Excellent
Heat Resistance	-10° to +100°C‡



Personalization, see page 184.

‡ Not for use in heated carts.

Note: All laminated trays must be dried before stacking.

RECOMMENDED USE

Moderate Traffic / Economic Priority

- Canteens / Cafeterias / Self-Serve
- Hotel Room Service
- Restaurants / Cafes
- Bars / Clubs / Pubs
- Catering
- Brasseries



Capri – Rectangular with Handles

CODE	OUTER DIMENSIONS	INNER DIMENSIONS
Rectangular with Handles		
1525RST	39,22 x 63,5 x 3 cm	35,6 x 53,3 cm
Case Pack: 12		



1525RST Tray Colors:



Brushed Steel (612)*



Venge (384)*



Walnut (376)

*Available in 1525RST only.



Capri – Oval

CODE	DIA / SIZE (CM)	CASE PACK
Oval		
CA1623	16,0 x 23,0	24
CA2026	20,0 x 26,5	24
CA2129	21,0 x 29,0	24



Capri – Laminated Trays with Smooth Surface

CODE	SIZE (CM)	CASE PACK
Rectangular		
CA2028	20,0 x 28,0	24
CA2632	26,5 x 32,5	24
CA2738	27,0 x 38,0	24
CA2836	28,0 x 36,0	24
CA3244	32,0 x 44,0	24
CA3253	32,5 x 53,0	24
CA3343	33,0 x 43,0	24
CA3446	34,0 x 46,0	24
CA3646	36,0 x 46,0	24
CA3748	37,0 x 48,0	24
CA3753	37,0 x 53,0	24
CA3952	39,0 x 52,0	24
CA4361	43,0 x 61,0	12

Capri – Rectangular



CODE	DIA / SIZE (CM)	CASE PACK
Round		
CA1300	∅ 13,0	24
CA3200	∅ 32,0	24
CA3800	∅ 38,0	24
CA4300	∅ 43,0	24

Capri – Round



Tray Pattern:

Thank You (E01)
Available in CA1300 only.



CODE	DIA / SIZE (CM)	CASE PACK
Trapezoid		
CA3247TR	32,0 x 47,0	24

Capri – Trapezoid



Tray Colors:

-  E73 Mahogany
-  E75 Birch
-  E76 Walnut
-  E77 Teak
-  E78 White
-  E79 Black
-  E80 Beige
-  E81 Grey
-  E82 Charcoal Granite

Madeira – Laminated Trays with Textured Wood Surface

SPECIFICATIONS

Material	Laminate
Surface Characteristics	Textured – Top and Bottom
Performance	Good
Stacking Lugs	No
Dishwasher Safe	Yes – Normal
Chemical Resistance	Excellent
Drying Test	Good
Shock Resistance	Good
Break Resistance	Good
Scratch Resistance	Good
Stain Resistance	Excellent
Heat Resistance	-10° to +100°C‡



Personalization,
see page 184.

‡ Not for use in heated carts.

Note: All laminated trays must be dried before stacking.

RECOMMENDED USE

Moderate Traffic / Economic Priority

- Canteens / Cafeterias / Self-Serve
- Hotel Room Service
- Restaurants / Cafes
- Bars / Clubs / Pubs



CODE	DIA/ SIZE (CM)	CASE PACK
Rectangular		
MA2435	24,0 x 35,0	24
MA3343	33,0 x 43,0	24
MA3646	36,0 x 46,0	24
MA4361	43,0 x 61,0	12
Rectangular with handle		
MA3142H	31,0 x 42,0	24
Trapezoid		
MA3652TR	36,0 x 52,0	24
Round		
MA3200	ø 32,0	24
MA3800	ø 38,0	24
MA4300	ø 43,0	24

Tray Colors:

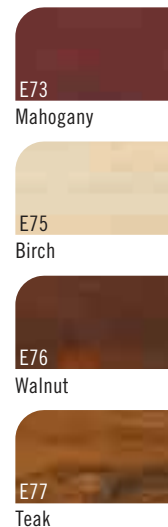

Fast Food Trays

SPECIFICATIONS

Material	Polypropylene
Surface Characteristic	Textured
Performance	Good
Stacking Lugs	Yes
Dishwasher Safe	Yes-Minimal**
Chemical Resistance	Excellent
Drying Test	Good
Shock Resistance	Good
Break Resistance	Good
Scratch Resistance	Good
Stain Resistance	Good
Heat Resistance	-10° to +80°C‡

‡ Not for use in heated carts.

** Wash once per day for 60 seconds at a maximum temperature of 80°C.



1418FF

RECOMMENDED USE

Moderate Traffic / Economic Priority

- Quick Serve Restaurants
- Food Courts / Snack Shops



High Profile Shape

High Profile Shape with handles



1217FFH

Available Colors:



CODE	DIA/ SIZE (CM)	CASE PACK
Rectangular – High Profile Shape		
1014FF	26,5 x 34,5	24
1216FF	30 x 41	24
1418FF	35 x 45	12
Rectangular – High Profile Shape with Handles		
1217FFH*	30 x 43	24

* Available in the following colors: Black (110), Sherwood Green (119), Orange (166), Brown (167), Cranberry (416).

* Personalization not available. Product non-returnable.



Personalization, see page 184.

Compartment Trays

SPECIFICATIONS

Name	Camwear® Polycarbonate	Budget	Penny-Saver
Code	10146CW	BCT1014	PS1014
Material	Polycarbonate	ABS	Co-Polymer
Surface Characteristic	Textured	Textured	Textured
Performance	Excellent	Excellent	Excellent
Stacking Lugs	Yes	Yes	Yes
Dishwasher Safe	Yes – Extensive	Yes – Extensive	Yes – Minimal
Chemical Resistance	Good	Excellent	Excellent
Drying Test	Excellent	Excellent	Excellent
Shock Resistance	Excellent	Good	Good
Break Resistance	Excellent	Good	Excellent
Scratch Resistance	Very Good	Very Good	Very Good
Stain Resistance	Very Good	Very Good	Very Good
Heat Resistance	-40° to +99°C‡	-10° to +82°C‡	-10° to +80°C‡

‡ Not for use in heated carts.

RECOMMENDED USE

Moderate Traffic /
Economic Priority

- School
- Universities
- Military

Two year prorated warranty for Camwear
Compartment Trays against breakage.

ABS and Co-Polymer trays are
not NSF listed.



Polycarbonate
Only

Camwear Polycarbonate Colors

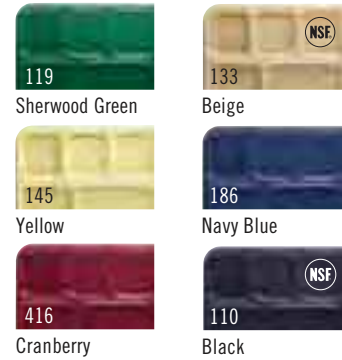

Budget Colors

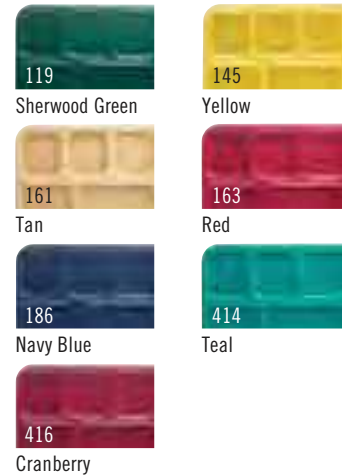

Penny-Saver Colors



PS1014



150CW, 100CW, 50CW, 45CW,
35CW, 10CW and SRB5CW
reusable bowls fit in this tray
and can be used to serve cereal,
soup & salads.



PS1014 on OETR314
Open End Tray Rack.

BCT1014



BCT1014, PS1014 & 10146CW

CODE	DIA/ SIZE (CM)	CASE PACK
Camwear Polycarbonate		
10146CW	25,4 x 36,5	24
Budget – ABS		
BCT1014	25,4 x 36,5	24
Penny-Saver – Co-Polymer		
PS1014	25,4 x 36,5	24

Compartment Trays

SPECIFICATIONS

Material	Camwear® Polycarbonate	Co-Polymer
Surface Characteristic	Textured	Textured
Performance	Excellent	Excellent
Stacking Lugs	Yes	Yes
Dishwasher Safe	Yes – Extensive	Yes – Minimal
Chemical Resistance	Good	Excellent
Drying Test	Excellent	Excellent
Shock Resistance	Excellent	Good
Break Resistance	Excellent	Excellent
Scratch Resistance	Very Good	Very Good
Stain Resistance	Very Good	Very Good
Heat Resistance	-40° to +99°C‡	-10° to +80°C‡

‡ Not for use in heated carts.



915CP



1596CW

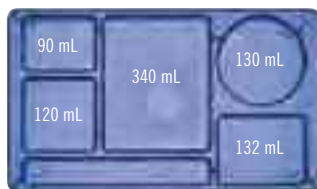

915CW & 915CP

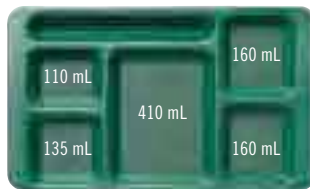

1596CW & 1596CP

CODE	DIA/ SIZE (CM)	CASE PACK
Camwear Polycarbonate		
1596CW	22,9 x 38	24
915CW	22,2 x 38	24
Co-Polymer		
1596CP	22,9 x 38	24
915CP	22,2 x 38	24



915CW and 1596CW inside two PR314 Camracks.

RECOMMENDED USE

Moderate Traffic / Economic Priority
– School
– Universities
– Military

100CW, SRB13CW and 50CW bowls fit in round compartment. 10CW and 150CW bowls fit in square compartment. See Dinnerware and Swirl Bowl sections.

Two year prorated warranty for Camwear Compartment Trays against breakage.

ABS and Co-Polymer trays are not NSF listed.

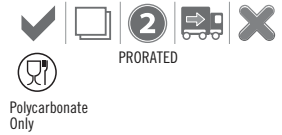

Polycarbonate Only

Camwear Polycarbonate

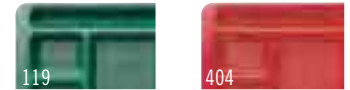

119 Sherwood Green

404 Red



133 Beige

414 Teal

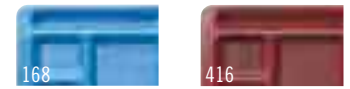

168 Blue

416 Cranberry



186 Navy Blue

110 Black



431 Translucent Blue

Co-Polymer



437 Grass Green

186 Navy Blue



145 Yellow

416 Cranberry

Compartment Serving Trays & Trapezoid Compartment Trays

Compartment Serving Trays

- For cafeteria-style feeding in high security environments.
- Compartment configurations designed to meet all menu requirements.

Camwear Polycarbonate
6-Compartment
Colors: Navy (186), Cranberry (416), Yellow (145), Sherwood Green (119), Beige (133).

5-Compartment Color: Beige (133).

Co-Polymer Colors:
 Brown (167), Tan (161).

Personalization not available.

Co-Polymer is not NSF Listed.



Trapezoid Compartment Trays

- Space saving tray for self serve correctional facility feeding.
- Offers seven deep compartments for ample, portion controlled servings.
- Serve soup and salad at the same time.

Camwear Color: Beige (133).

Trapezoid Compartment Trays are covered by the following U.S. Patent D 508,634.



NT9CP Co-Polymer Cup: For details contact your Cambro representative.



10146CW



14187TRCW

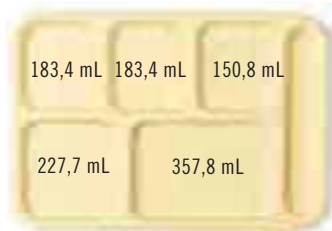

10146CW

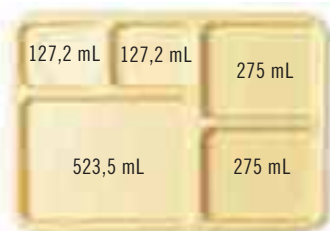

10145CW



14187TRCW

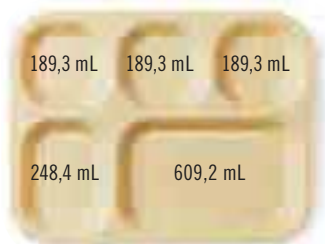

14105CW

Also Available in 14105CP

CODE	DESCRIPTION	DIMENSIONS L x W x D (CM)
Camwear Polycarbonate		
10146CW	6 Compartments	25,4 x 36,8 x 2,4
14105CW	5 Compartments	27,2 x 35,2 x 2,9
10145CW	5 Compartments	25,4 x 36,8 x 2,4
Co-Polymer		
14105CP	5 Compartments	27,2 x 35,2 x 2,9

Case Pack: 24

CODE	DESCRIPTION	DIMENSIONS L x W x D (CM)
Camwear Polycarbonate		
14187TRCW	7 Compartments	45,6 x 35,4 x 4,0
Case Pack: 12		

Meal Delivery Trays & Separator® Compartment Trays

Meal Delivery Trays

- Three deep-dish food compartments for large portions.
- Snap-on cover fits securely.
- Textured surface minimizes scratching.

Camwear Polycarbonate Colors:
Beige (133), Teal (414).
Lid Color: Clear (135).

Co-Polymer Colors:
Teal (414), Brown (167), Tan (161).
Lid Color: White (148).

Personalization not available.

Co-Polymer is not NSF Listed.

Not for use in heated carts.



Separator Compartment Trays

- Six compartment tray designed specifically for in-cell feeding programs.
- Serve both hot and cold food from the same tray.
- Tray with cover separates each compartment to retain food temperature and reduce spills.
- Locking ridges on top of cover and bottom of tray ensure more secure stacking.

Camwear Polycarbonate Color:
Beige (133).
Lid Color: Clear (135).

Co-Polymer Colors:
Teal (414), Brown (167), Tan (161).
Lid Color: Translucent (190).

Personalization not available.

Co-Polymer is not NSF Listed.

Not recommended for heated cart.

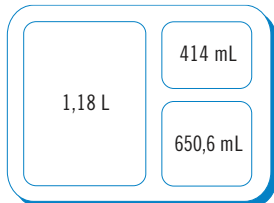

9113CW/9113CP

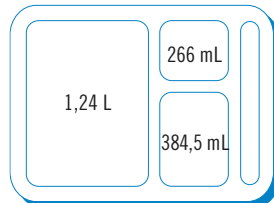

9114CW/9114CP

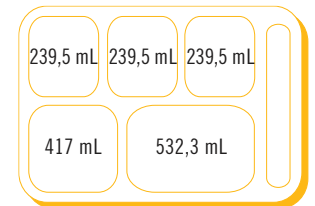

10146DCW/10146DCP



CODE	DESCRIPTION	DIMENSIONS L x W x D (CM)
Camwear Polycarbonate		
9113CW	3 Compartments	23 x 28 x 6,5
9114CW	4 Compartments	23 x 28 x 6,5
911CWC	Lid fits both trays	22,8 x 27,9 x 1,4
Co-Polymer		
9113CP	3 Compartments	23 x 28 x 6,5
9114CP	4 Compartments	23 x 28 x 6,4
911CPC	Lid fits both trays	22,6 x 27,4 x 1,4

Case Pack: 24

CODE	DESCRIPTION	DIMENSIONS L x W x D (CM)
Camwear Polycarbonate		
10146DCW	6 Compartments	25,4 x 36 x 2,9
10146DCWC	Lid fits 10146DCW	25,6 x 35,6 x 3,6
Co-Polymer		
10146DCP	6 Compartments	25,4 x 36 x 2,9
10146DCPC	Lid fits 10146DCP	25,6 x 35,6 x 3,6

Case Pack: 24

Tray on Tray Meal Delivery System

Combine pre-plated hot and cold food portions into a reusable, single service unit designed for in-cell feeding and cook-chill applications.

Base Tray

- Combine pre-plated hot and cold food portions into a reusable, single service unit.
- Works as a tray or for in-cell feeding with the insert tray.
- Base tray has 5 compartments with 1 compartment for resting the insert tray.

Camwear Polycarbonate Color:
Beige (133).

Co-Polymer Colors:
Brown (167), Tan (161).

Personalization not available.

1411CW is NSF Listed.

Co-Polymer is not NSF Listed.

Not for use in heated carts.



1411CW/1411CP



1411CW



1411CW base tray with 853FH insert tray

CODE	DESCRIPTION	DIMENSIONS L x W x D (CM)
Camwear Polycarbonate		
1411CW	Compartments	36,5 x 26,8 x 3,3
Co-Polymer		
1411CP	Compartments	36,5 x 26,8 x 3,3

Case Pack: 24

Insert Tray

- Designed specifically for cook-chill applications as it can be covered with heat seal film or snap-on cover.
- Eight trays efficiently fit on a standard sheet pan or in an 45,5 x 65,5 cm wire rack.

Camwear Polycarbonate Color:
Beige (133).

Lid Color: Clear (135).

Co-Polymer Colors:
Brown (167), Tan (161).

Lid Color: Translucent (190).

Heat Resistant Plastic Tray and Lid Color: Amber (150).

Personalization not available.

853FCW, 853FCWC, 853FH and 853FHC are NSF Listed.

Co-Polymer is not NSF Listed.

Not for use in heated carts.



853FCW/853FCP/853FH



CODE	DESCRIPTION	DIMENSIONS L x W x D (CM)
Camwear Polycarbonate		
853FCW	Compartments	22,1 x 16 x 4,8
853FCWC	Lid for 853FCW	—
Co-Polymer		
853FCP	Compartments	22,1 x 16 x 4,8
853FCPC	Lid for 853FCP	—
Heat Resistant Plastic		
853FH	Compartments	22,1 x 16 x 4,8
853FHC	Lid for 853FH	—

Case Pack: 24

Polycarbonate Camwear® Trays

Market Trays

SPECIFICATIONS

Material	Polycarbonate
Surface Characteristic	Textured
Performance	Excellent
Stacking Lugs	Yes
Dishwasher Safe	Yes – Extensive
Chemical Resistance	Good
Drying Test	Excellent
Shock Resistance	Excellent
Break Resistance	Excellent
Scratch Resistance	Very Good
Stain Resistance	Very Good
Heat Resistance	-40° to +99°C‡



‡ Not for use in heated carts.

RECOMMENDED USE

Moderate Traffic / Economic Priority

- Schools
- Universities
- Canteens / Cafeterias / Self-Serve
- Military
- Quick Serve Restaurants
- Food Courts / Snack Shops

Colors: Blue (168), Beige (133).

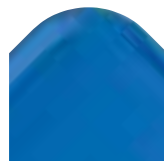

High Profile Shape

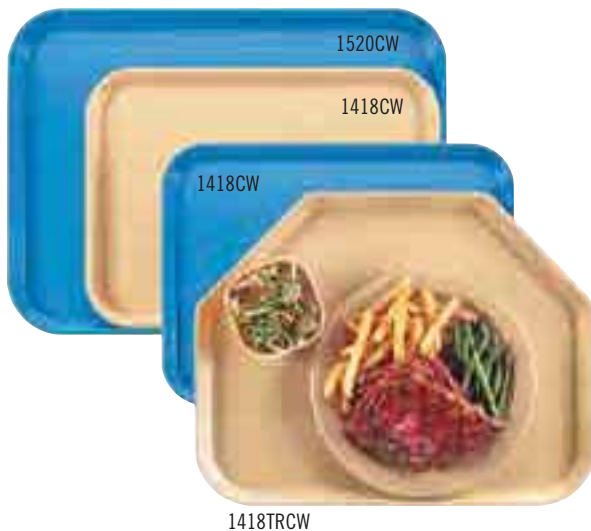

1418TRCW

CODE	DIA/ SIZE (CM)	CASE PACK
Rectangular – High Profile Shape		
1418CW	35,5 x 46	12
1520CW	38 x 51	12
Trapezoid – High Profile Shape		
1418TRCW	35,5 x 46	12

SPECIFICATIONS

Material	Fiberglass Layers + Polyester Resin
Surface Characteristic	Smooth
Performance	Excellent
Stacking Lugs	Yes
Dishwasher Safe	Yes – Extensive
Chemical Resistance	Good
Drying Test	Excellent
Shock Resistance	Excellent
Break Resistance	Good
Scratch Resistance	Good
Stain Resistance	Excellent
Heat Resistance	-10° to +100°C‡

‡ Not for use in heated carts.

RECOMMENDED USE

Moderate Traffic / Economic Priority

– Deli / Buffet Displays

Colors: Salmon (149), Yellow (145), Blue (142), Green (140), White (148), Black (110).

Colors NSF listed for food contact: Black (110), White (148), Blue (142), Green (140).

* Special order item not carried in stock – non-returnable.

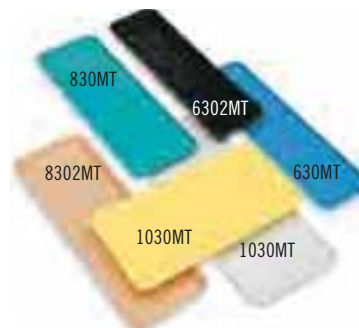

CODE	DIA/ SIZE (CM)	CASE PACK
Market Trays		
630MT*	16,4 x 76,2 x 1,9	12
826MT*	21,6 x 64,1 x 1,9	12
830MT*	21,4 x 76,2 x 1,9	12
913MT*	22 x 31,6 x 2,1	12
918MT*	22 x 45,7 x 2,1	12
926MT*	22,5 x 64,9 x 2,5	12
1015MT*	25,7 x 38,1 x 1,9	24
1030MT*	26,5 x 76,2 x 1,9	12
1218MT*	29,2 x 45,1 x 2,5	12
1224MT*	31,6 x 61 x 1,9	12
1230MT*	31,6 x 76,2 x 1,9	12
1318MT*	32,1 x 45,1 x 2,7	12
1826MT*	45,2 x 65,2 x 2,7	6
2025MT*	52,7 x 64,9 x 2,1	6
Market Pans		
6302MT*	16,7 x 76,2 x 5,1	12
8262MT*	21,5 x 64,1 x 5,1	12
8302MT*	21,4 x 76,2 x 5,1	12
92615MT*	22,5 x 64,8 x 3,8	12
10302MT*	26,5 x 76,2 x 5,1	12



CAMBRO *Healthcare*

The Cure for the Common Kitchen™



Healthcare



Meal Delivery Ware

Reusable CamLids® for Meal Delivery Systems

Camshelving® Tray Drying Rack System

Camshelving Mobile Drying and Storage Units

Disposable CamLids®

Microban® Antibacterial Camguard® Versa Trays

Polyester Decorated Versa Trays with Non-Slip Surface

Non-Skid Versa Lite Trays

Non-Skid Versa Camtrays®

Tablotherm Meal Delivery System

Low Profile 10-Tray Meal Delivery Cart

Meal Delivery Carts for Tray Service



Why Cambro Healthcare?

For over 60 years Cambro has been focused on developing innovative solutions to the toughest challenges in the foodservice industry. Cambro Healthcare products are designed to perform consistently under the most demanding conditions of healthcare foodservice.

The Components for Successful Meal Service and Patient Satisfaction

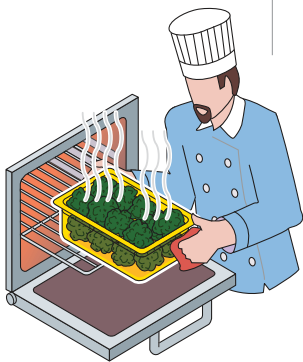
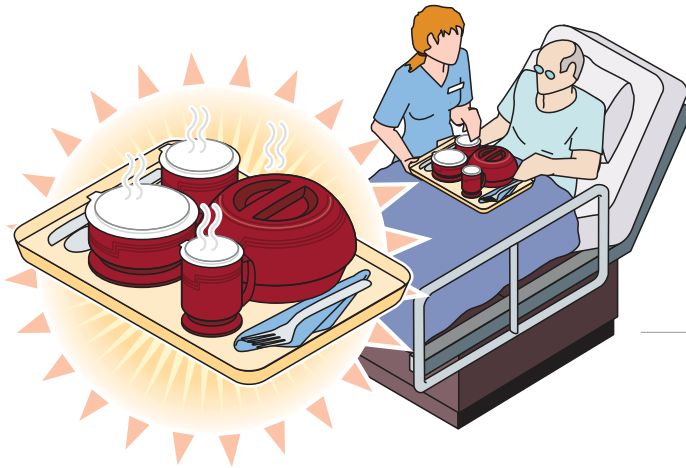

Hot Food

The goal of any meal delivery system is to keep food hot and fresh. Safe food handling and preparation are the first steps.

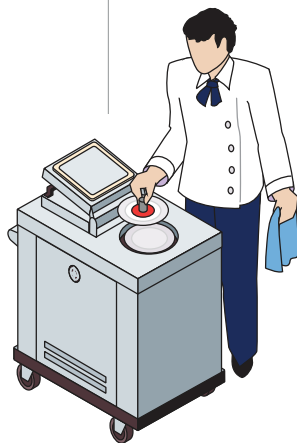

Hot Plate

Hot food needs a plate heated to proper temperatures. A plate that is not heated diminishes food quality for patients.

Plates should be heated between 65°C and 77°C.



Temperature Maintenance System

NSF-listed, meal delivery ware consisting of mugs, bowls, insulated domes and heated bases/pellets specifically designed for healthcare foodservice are vital to temperature maintenance.

Bases and Pellets should be heated between 132°C and 144°C.



Meal Transportation

From meal delivery carts to individual Tablotherm meal transport systems, these products can extend the heat retention of the meal to the patient's bedside.

Tablotherm Pellet System achieves temperature retention of 64°C for 2 hours.

Meal Delivery Ware

Camtherm® Thermal Pellet System

The perfect choice for maximum heat retention.



CODE	MDS09	MDSL09	MDSL9	MDSPLT9	MDSP9
DESCRIPTION	Insulated Dome covers 22,86 cm plate	Low Profile Insulated Dome covers 22,86 cm plate	Pellet Underliner holds 24,13 cm pellet	Ceramic Plate	Thermal Pellet holds 22,86 cm plate
OUTSIDE DIAMETER	25,94 cm	25,94 cm	24,29 cm	22,86 cm	24 cm
HEIGHT	8,17 cm	6,99 cm	4,6 cm	2,54 cm	4,45 cm
FULL-SIZE CAMRACK®	PR59314	PR59314	PR59314	CRP20910	PR59314
CASE PACK	12	12	12	24	12

MDS09, MDSL09 and MDS09B Colors: Meadow (447), Wheat (457), Speckled Gray (480), Cranberry (487), Navy Blue (497), Black (110).

MDSP9 Color: Dark Gray (477). MDSP9 for use with CHPEL80.

MDSPLT9 Color: Ivory (000). MDSPLT9 Sold in full cases only. MDSL9 and MDSP9 are NSF listed.

Heat Keeper Insulating Base System

The cost-effective solution for heat retention.



CODE	MDS09	MDSL09	MDSPLT9	HK39B
DESCRIPTION	Insulated Dome for 22,86 cm plate	Low Profile Insulated Dome for 22,86 cm plate	Ceramic Plate	Insulating Base for 24,13 cm plate
OUTSIDE DIAMETER	25,94 cm	25,94 cm	22,86 cm	24,48 cm
HEIGHT	8,17 cm	6,99 cm	2,54 cm	4,07 cm
FULL-SIZE CAMRACK®	PR59314	PR59314	CRP20910	PR59314
CASE PACK	12	12	24	12

MDS09, MDSL09 and HK39B Colors: Meadow (447), Wheat (457), Speckled Gray (480), Cranberry (487), Navy Blue (497), Black (110).

MDSPLT9 Color: Ivory (000). MDSPLT9 Sold in full cases only. HK39B is NSF listed.

Low Profile Insulated Dome Comparison

Perfect for limited tray spacing as low as 11,43 cm



* This height is measured from a flat surface.

Insulated Accessories



CODE	MDSM8	MDSB5	MDSB9	MDSB16	MDSPL
DESCRIPTION	Insulated Mug	Insulated Sm. Bowl	Insulated Lg. Bowl	Insulated Entree Bowl	Pellet Lifter
APPROX. CAPACITY	240 mL	150 mL	270 mL	500 mL	—
OUTSIDE DIAMETER	8,89 cm	8,89 cm	11,11 cm	13,65 cm	8,0 cm
HEIGHT	10,16 cm	6,1 cm	6,1 cm	6,1 cm	7,6 cm
FULL-SIZE CAMRACK®	16C414	16C414	9S318	9S318	—
CASE PACK	48	48	48	48	1

* MDSM8 Diameter 11,43 cm with Handle. **MDSPL Color:** (000). *MDSPL is not NSF listed.

The Shoreline Collection Colors:



Meadow



Wheat



Cranberry



Navy Blue



Black



Speckled Gray



Safely lift hot, thermal pellets or plates with the Cambro Pellet Lifter.

Reusable CamLids® for Meal Delivery Systems

- Save up to 75% in lid costs each year.
- Reduce your waste-stream significantly each year when you switch from disposables to reusables.*
- Dishwasher safe.
- Contact your Cambro Sales Representative for a Customized Savings Calculator!

Reusable Lids Colors:

Speckled White (490), Midnight Blue (453).

Camrack Wash and Store Rack Color:

Kelly Green (452).

Camrack Base Full Size Color:

Soft Grey (151).

Full Rack Cover Color: Grey (180).

CLRWSR36 is covered under U.S. patent D 617,069.

Full Rack Cover not NSF certified.



Visit www.cambro.com/savemoney for a Customized Savings Calculator!

Camrack® Wash and Store Rack

- Specifically designed for safely and securely washing and storing Reusable CamLids.
- Each Camrack Wash and Store Rack holds 36 Reusable CamLids.
- 2 Wash and store Racks fit in a Full Size Base Rack.



CLRWSR36



BR578

CODE	DESCRIPTION	DIMENSIONS (CM)	CASE PACK
Reusable CamLids		H x Dia.	
CLRSMB5	Fits Shoreline 240 mL mug and 150 mL bowl	0,71 x 9,05	240
CLRSB9	Fits Shoreline 270 mL bowl	0,71 x 11,32	240
CLRSB16	Fits Shoreline 500 mL bowl	0,71 x 13,97	240
Accessories for CLRSMB5 and CLRSB9		L x W x H	
CLRWSR36	Camrack Wash and Store Rack to wash 36 Reusable Lids	20,96 x 45,4 x 13,97	4
BR578	Camrack Full Size Base Rack with 2 extenders	50 x 50 x 18,4	4
DRC2020	Full Rack Cover	50 x 50 x 2,4	1
Accessories for CLRSB16		L x W x H	
PR500	9 x 9 Peg Rack with 1 Extender	50,17 x 50,17 x 14,29	5
E3	Full Size Open Extender	50,17 x 50,17 x 2	12
CRPHDG2878	Full Size Square Hold Down Grid	46,67 x 46,67	6

Reusable CamLids sold in cases only. No broken cartons.

Camshelving® Drying Rack System



- Drying rack has 7-slots to securely hold various sized trays.
- Convert existing shelf units by removing shelf plates and replacing with drying racks.
- Lifetime warranty against rust and corrosion on Posts and Traverses.
- Each slot can hold a maximum product thickness of 33 mm.
- Drying Rack Material: High Impact ABS.
- Visit Camshelving section of the catalog for additional details.

Drying Rack Color: Soft Gray (151).

Camshelving Drying Rack System is covered by U.S. Patent D 663,912 S.



COMPONENT



CSDR7
Tray Drying Rack

Drying Racks

CODE	DIMENSIONS L x W x H	CASE PACK
CSDR7	594 x 240 x 96,52 mm	1
CSDR73	594 x 240 x 96,52 mm	3

Color: Soft Grey (151). Shelf Plates not Included.

Drying Rack Mobile Units

CODE	DIMENSIONS L x W x H
Camshelving Drying Rack Mobile Units	
CSDRC244875PKG	1220 x 610 x 1910 mm
CSDRC246075PKG	1530 x 610 x 1910 mm
Camshelving Elements Dry Rack Mobile Units	
EDRC244878PKG	1220 x 610 x 1980 mm
EDRC246078PKG	1530 x 610 x 1980 mm

Camshelving Drying Rack Mobile Unit Color: Speckled Grey (480).

Camshelving Elements Rack Mobile Unit Color: Brushed Graphite (580).

Package Includes: Drying Racks for three levels, six mobile traverses, two mobile post kits, premium (2 swivel, no brake, 2 swivel with brake) casters and instruction manual.



CSDRC244875PKG
Camshelving Drying
Rack System



EDRC244878PKG
Elements Drying
Rack System

Camshelving® Mobile Drying and Storage Units



- Keeps trayline and dishwashing areas organized and efficient.
- Cradles made of stainless steel.
- Shelving posts and traverses feature a steel core with a smooth polypropylene exterior.
- Cradles are removable and fit into a Camrack® base rack for dishwasher service.
- Dome Drying Rack holds 100 each 25,4 cm domes and/or pellet underliners.
- Camduction Base Drying Rack holds 180 each Camduction Bases, and/or Camtherm® Thermal Pellets.

Color:
Cart - Speckled Grey (480),
Cradle - Stainless Steel (000).

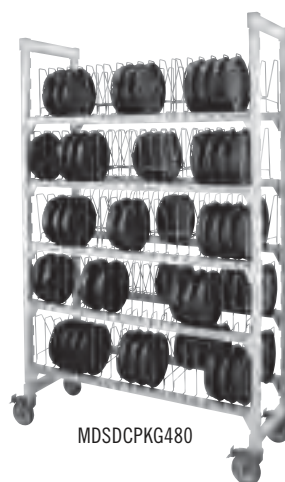

MDSDCPKG480



CSDDCPKG480

CODE	DESCRIPTION	DIMENSIONS L x W x H
CSDDCPKG480*	Camshelving Mobile Dome Drying and Storage Unit	91 x 46 x 191 cm
MDSDCPKG480**	Camshelving Mobile Base and Thermal Pellet Drying and Storage Unit	121,9 x 45,7 x 190,5 cm
CSDC	Dome Drying Cradle	41 x 45 x 25,4 cm
CSPDC5	Camduction Base and Thermal Pellet Drying Cradle	34,8 x 45,24 x 25,4 cm

Case Pack: 1 CSPDC5 Case Pack: 5

*Ships in 3 cartons, Carton 1: 2 Post Kits, 10 Traverses and 4 Casters (2 swivel, 2 fixed with breaks), Carton 2: Set of 5 Drying Cradles, Carton 3: Set of 5 Drying Cradles.

**Ships in 7 cartons.

Disposable CamLids® for Shoreline



LID CODE	CLSM8B5	CLSB9	CLSB16	CLSSM8B5
DESCRIPTION	Sm. Disp. Lid	Lg. Disp. Lid	Disp. Entree Bowl Lid	Disp. Sip. Lid
FITS	MDSB5, MDSM8	MDSB9	MDSB16	MDSB5, MDSM8
OUTSIDE DIAMETER	9,1 cm	11,28 cm	13,97 cm	9,1 cm
HEIGHT	0,76 cm	0,76 cm	0,76 cm	1,9 cm
CASE PACK	1,500	1,000	1,000	1,000

CLSM8B5, CLSB9 and CLSB16 Color: Translucent (190). CLSSM8B5 Color: White (148).
Sold in full cases only. No broken cartons.

Disposable CamLids® for Tumblers and Bowls



Disposable Lids for Newport® Tumblers

LID CODE	CLNT5	CLNT8	CLNT10	CLNT12
FITS TUMBLERS	NT5	NT8	NT10	NT12
TUMBLER CAPACITY	189 mL	228 mL	300 mL	373 mL
CASE PACK	1,500	1,000	1,000	1,000

Color: Translucent (190). Sold in full cases only. No broken cartons.



Disposable Lids for Laguna® Tumblers

LID CODE	CLLT6	CLLT10	CLLT12
FITS TUMBLER	LT6	LT10	LT12
TUMBLER CAPACITY	177,4 mL	295,7 mL	354,9 mL
CASE PACK	1,500	1,000	1,000

Color: Translucent (190). Sold in full cases only. No broken cartons.

Disposable Lid for Swirl Bowls

LID CODE	CLSRB5
FITS SWIRL BOWLS	SRB5CW / SRB5
SWIRL BOWL CAPACITY	148 mL
CASE PACK	1,000

Color: Clear (152). Sold in full cases only. No broken cartons.



Disposable Lids for Colorware Tumblers

LID CODE	CLJ6	CL900P	CL950P
FITS TUMBLERS	500P / 500P2	900P / 900P2	950P / 950P2
TUMBLER CAPACITY	154 mL	287 mL	290 mL
CASE PACK	1,000	1,000	1,000

Color: Translucent (190). Sold in full cases only. No broken cartons.

Microban® Antibacterial Camguard® Versa Trays

- High performance polyester tray for ultra-intensive use.
- Built-in Microban® antibacterial protection eliminates bacteria between tray washings and will not wash off or wear away for the life of the tray.
- Reinforced polyester corners provide superior corner and edge protection against impact.
- Stacking lugs allow air circulation for fast drying and perfect stacking.
- Temperature range resistance from -40°C to 140°C.‡
- Dishwasher safe – Wash as often and as frequently as needed.



‡ Not for use in heated carts.

CAMGUARD
ANTIBACTERIAL



High Profile Shape

Low Profile Design Shape



Flat Edge Shape



Built-in Antimicrobial Protection from Microban Eliminates Bacteria

Microban 3G-Silver™ is built into every Cambro Camguard Versa Tray to protect against the harmful effects of bacteria. Microban eliminates existing bacteria and prevents the growth of new bacteria. This protection cannot be washed off and does not wear away over time. This built-in defense lasts for the life of the tray.

Unprotected Surface versus Microban 3G-Silver™ Treated Surface 24 Hour Test

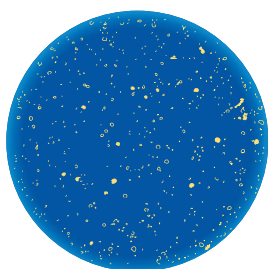

Untreated

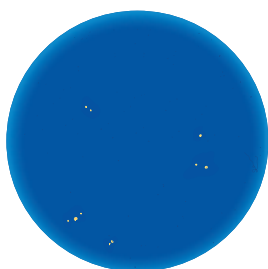

Treated with Microban®

CODE	DIMENSIONS (CM)
Versa Trays – High Profile Shape	
VT1418AB	35,5 x 45,7
VT3343AB	33,0 x 43,0
Versa Century™ Trays – Low Profile Design Shape	
VT3646CAB	35,5 x 45,7
VT3343CAB	32,9 x 42,9
Versa Trays – Flat Edge Shape	
GP1070AB*	32,5 x 26,5
GP1080AB*	37,0 x 26,5
GP3980AB*	53,0 x 37,0
GP4002AB*	53,0 x 32,5

Case Pack: 12

* Designed with reinforced corners for automatic off-stacking onto conveyor belt dishwashers.



Innovative low profile and low corner design increases space utilization of tray surface and customer comfort while eating.



Reinforced polyester corners provide superior corner and edge protection against impact.



Stacking lugs allow free air circulation for fast drying and perfect stacking.

Tray Color:

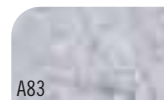

A83
Granite

Polyester Decorated Versa Trays with Non-Slip Surface

- Reduce waste, save money and provide a stable tray surface for meal delivery.
- Switching from paper tray mats will generate annual savings of over 50%.
- Your Green Initiatives will get rapid results with the elimination of up to 10 tons of trash each year.
- High performance polyester tray for ultra-intensive use.
- Reinforced polyester corners provide superior corner and edge protection against impact.
- Stacking lugs allow air circulation for fast drying and perfect stacking.
- Temperature range resistance from -40°C to 80°C.‡
- Dishwasher safe – Wash as often and as frequently as needed.



Personalization: Contact your Cambro representative for pricing.
‡ Not for use in heated carts.



Flat Edge Shape

CODE	DIA/ SIZE (CM)	CASE PACK
Versa Trays – Flat Edge Shape		
GP3980NS*	53,0 x 37,0	12
GP4002NS*	53,0 x 32,5	12
GPO540NS*	46,0 x 34,4	12
GP1080NS*	37,0 x 26,5	12

* Designed with reinforced corners for automatic off-stacking onto conveyor belt dishwashers.



Non-Skid Trays grip firmly providing safer meal delivery service.

Patterns and Tray Base Colors:

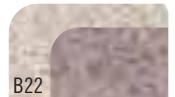

B22
Sahara on Sahara Tray



B93
Titan on Granite Tray



B31
Lava on Speckled Blue Tray



B99
Pebbled Black on Light Grey Tray



B100
Pebbled Black on Terrazzo Tray

Non-Skid Versa Lite Trays

- Non-Skid surface provides a better grip for safer meal delivery.
- Reduce your environmental waste-stream each year when you switch from paper tray mats to Non-Skid Versa Lite Trays.
- Standard performance polyester tray for intensive use.
- Reinforced polyester corners provide superior corner and edge protection against impact.
- Stacking lugs allow air circulation for fast drying and perfect stacking.
- Temperature range resistance from -40°C to 80°C.‡
- Dishwasher safe – Wash up to 3 times per day.



Personalization: Contact your Cambro representative for pricing.
‡ Not for use in heated carts.



High Profile Shape

Low Profile Design Shape



Flat Edge Shape



Versa Lite Century Trays have low edges and ergonomic corners that enhance comfort.



Stacking lugs allow free air circulation for fast drying and perfect stacking.



Reinforced polyester corners provide superior corner and edge protection against impact.

Tray Colors:



B22
Sahara on Sahara Tray



B14
Titan on Speckled Smoke Tray

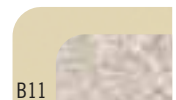

B11
Sahara on Pearl White Tray



B99
Pebbled Black on Light Grey Tray

CODE	DIMENSIONS (CM)
Versa Trays – High Profile Shape	
VL1418NS	35,5 x 45,7
VL3343NS	33,0 x 43,0
Versa Century™ Trays – Low Profile Design Shape	
VL3646CNS	35,5 x 45,7
VL3343CNS	33,0 x 43,0
Versa Trays – Flat Edge Shape	
GL3980NS*	53,0 x 37,0
GL4002NS*	53,0 x 32,5

Case Pack: 12

* Designed with reinforced corners for automatic off-stacking onto conveyor belt dishwashers.



Non-Skid Trays grip firmly providing safer meal delivery service

Non-Skid Versa Camtrays®

- Non-Skid Trays reduce waste, save money and provide a stable tray surface for meal delivery.
- Switching from paper tray mats will generate annual savings over 50%.
- Green Initiatives will get rapid results with the elimination of tons of trash each year.
- Non-Skid Camtrays provide a better grip for safer meal delivery.
- Dishwasher safe in low and high temperatures.
- Stacking lugs allow for quick drying.
- Temperature range resistance from -40°C to 80°C. ‡

Camtray and Dietary Tray Colors:
Black with Pebbled Black (382), Pearl Gray with Titan (381), Ivory with Sahara (380).

Century Camtray Colors: Pearl Gray with Titan (381), Ivory with Sahara (380).



Personalization: Contact your Cambro representative for pricing.
‡ Not recommended for heated carts.



High Profile Shape Low Profile Design Shape



Flat Edge Shape



Versa Dietary Tray

CODE	DESCRIPTION	DIMENSIONS
1418VC	Non-Skid Versa Camtray	36 x 46 cm
1520VC	Non-Skid Versa Camtray	38 x 51 cm
1520VDC*	Non-Skid Versa Dietary Tray	38 x 51 cm
1418VCC	Non-Skid Versa Century Camtray	36 x 46 cm
1520VCC	Non-Skid Versa Century Camtray	38 x 51 cm

Case Pack: 12 *1520VDC only available in Black with Pebbled Black (382).



Non-skid trays grip table top items firmly.

Personalization available.
Visit www.cambro.com for details.

Non-Skid Versa Camtrays for Room Service

- Ergonomic handles allow for safe and elegant meal delivery.
- Trays fit within existing meal delivery carts for 38 x 51 cm trays.
- Non-skid surface eliminates the need for tray mats saving time and money.
- Dishwasher safe at high and low temperatures.
- Stacking lugs allow for quick drying.
- Temperature range resistance from -40°C to 80°C. ‡

Room Service Tray Colors:
Black with Pebbled Black (382), Pearl Gray with Titan (381), Ivory with Sahara (380).

Non-Skid Versa Camtrays for Room Service is covered by U.S. Patent D 683,191 S.



Personalization: Contact your Cambro representative for pricing.
‡ Not recommended for heated carts.



CODE	DESCRIPTION	DIMENSIONS
1520VCRST	Room Service Non-Skid Camtray	38 x 51 cm

Case Pack: 12

Tablotherm Meal Delivery System

The ideal single-serve meal delivery system for in-home service.

- Transport and serve hot and cold food in one complete unit.
- Maintain safe food temperatures for over 1 hour.
- Lightweight design makes transportation easy and convenient.
- Two sizes accommodate a variety of meal options.
- Dishwasher safe.



Tablotherms stack for easy transportation and storage.



CFC-free foamed-in insulation.

Molded-in dimples secure the sealed lids on dishware to prevent spills and enhance temperature retention.

Break-resistant china dishware.

Compact design makes transport easy.



Safely hold hot and cold meals in one unit.



Meal set-up is convenient with Tablotherm trays and dishes.



Tablotherms are designed for dining comfort.

Tablotherm Insulated Trays

SPECIFICATIONS

Material	Polypropylene + Foam Insulation
Characteristic	Insulated Tray
Performance	Excellent
Heat Retention	Approximately 60 Minutes*
Dishwasher Safe	Yes
Stackable	Yes
Minimum Food & Plate Temperature before Plating	85°C - 90°C
Individual Dish Cover	Yes – Prevent Spilling of Soup and Sauces



*With heated pellet.
Not for use in heated carts.

ITPD3253 model with Heated Pellet	85°C	80°C	77°C	74°C	71°C
ITPD3253 model without Heated Pellet	85°C	72°C	68°C	64°C	—
ITPD3753 model with Heated Pellet	87°C	79°C	73°C	68°C	64°C
ITPD3753 model without Heated Pellet	87°C	70°C	63°C	—	—

Starting Temperature 20 min. 40 min. 60 min. 80 min.



ITPD3253 - Gastronorm size



ITPD3753 - Euronorm size



Light gray polypropylene lid with integrated rubber seal. Lids cannot be used in microwave oven.

For a complete guide to maximizing heat retention, contact your Cambro representative.

CODE	DESCRIPTION	DIMENSIONS W x L x H (CM)
Tablotherm – Insulated Tray with Porcelain Dishes, seal covers and pellet		
ITPD3753	Euronorm insulated tray including: 1 ea. two-compartment menu plate - 122 400 050 and 1 ea. cover 122 600 050 and 1 ea. pellet 165PW 3 ea. multiple-use bowl - 122 500 050 and 3 ea. cover 122 700 050.	37,0 x 53,0 x 10,5
ITPD3253	Gastronorm insulated tray including: 1 ea. two-compartment menu plate - 122 400 050 and 1 ea. cover 122 600 050 and 1 ea. pellet 165PW 2 ea. multiple-use bowl - 122 500 050 and 2 ea. cover 122 700 050.	32,5 x 48,0 x 10,5
Tablotherm – Insulated Tray without porcelain dishes, seal covers and pellet		
IT3753	Euronorm insulated tray – Empty	37,0 x 53,0 x 10,5
IT3253	Gastronorm insulated tray – Empty	32,5 x 48,0 x 10,5
Porcelain dishes		
122 400 050	Two compartment menu plate. Outside ø 254 mm. Capacity 750 ml. White.	
122 500 050	Multiple-use bowl. Outside ø 120 mm. Capacity 400 ml. White.	
Latches		
122 201 050	Latches with menu card holder	
122 200 050	Latches without menu card holder	
Food covers, light gray, polypropylene with integrated rubber seal		
122 600 050	For two compartment menu plate	
122 700 050	For multiple-use bowl	
Pellet System		
165PW	SMC pellet ø 16,5 cm	
Menu card		
112 430 000	Yellow 100 x 70 mm	

ITPD3753, IT3753 Color: Two Tone Green.

ITPD3253, IT3253 Color: Two Tone Gray.

165PW Color: A42 **165PW Case Pack:** 1 Each.

Low Profile 10-Tray Meal Delivery Cart



- Enhance patient satisfaction with high quality, room-service style meals served quietly and efficiently.
- The Cambro 10-Tray Meal Delivery Cart is non-electric and requires no assembly.
- Made of durable and easy-to-clean polyethylene, this cart won't dent or rust and will provide years of reliable service.
- Holds up to ten 38 x 51,5 cm or Euronorm 37 x 53 cm trays.



Large, molded-in ergonomic handle makes it easy to transport and maneuver.

Molded-in marine rail creates additional work surface during service. *Marine rail is designed for use during service, not transport.*



One louvered vent on the back supports air circulation.



Polyurethane insulation ensures quiet meal delivery and provides structural strength.

Molded-in full-perimeter bottom bumper protects the cart, walls & furniture.

Molded-in rails ensure quiet meal delivery, rail spacing up to 13,34 cm.



Menu clip holds routing directions or content lists.

Lightweight, self-venting, ABS door is non-insulated and opens a full 270°.

Shown with four, 13 cm non-marking, offset, durable stainless steel casters (2 fixed and 2 swivel with brake). Heavy duty casters are available.

CODE	MDC1520S10	MDC1520S10HD
TRAY SIZE	38 x 51,5 cm & 37 x 53 cm	38 x 51,5 cm & 37 x 53 cm
TRAYS PER RAIL / RAIL SPACING	2 / 13,3 cm	2 / 13,3 cm
EXTERNAL DIMENSIONS W x D x H	72,4 x 97,8 x 108 cm	72,4 x 97,8 x 110,5 cm
INTERNAL DIMENSIONS W x D x H	53,7 x 78,7 x 66,7 cm	53,7 x 78,7 x 66,7 cm
CASTER TYPE	Standard Casters 12,7 x 3,2 cm	Heavy Duty Casters 15,24 x 5,1 cm
UNIT WEIGHT	35,4 kg	40,8 kg

Case Pack: 1 Colors: Granite Gray (191) and Granite Sand (194).

Meal Delivery Carts for Tray Service (20 Tray Capacity)



- Use to transport meal trays from the kitchen to acute care patients, nursing home residents or correctional facility inmates.
- Enhance patient satisfaction with high quality, room-service style meals served quietly and efficiently.
- Tough, one-piece, double-wall polyethylene carts are easy to clean and won't rust, dent, crack, chip or break.
- All units have light-weight non-insulated ABS doors.
- All meal delivery carts come standard with stainless steel casters except the MDC1411T60 which comes standard with plated casters.

Colors (All carts with Cream Door):
 Grey (180), Slate Blue (401),
 Granite Grey (191), Granite Green (192),
 Granite Sand (194).

MDC1520T16 and MDC1418T16 are covered by U.S. Patent D 398,727.



MDC1520S20
 Back View with Louvered Vents

Marine rail is designed for use during service, not transport.



Low Profile

CODE	MDC1520S20	MDC1418S20
TRAY SIZE	38 x 51,5 cm	36 x 46 cm
TRAYS PER CART	20	20
TRAYS PER COMPARTMENT	10	10
RAILS PER COMPARTMENT	5	5
TRAYS PER RAIL	2	2
RAIL SPACING	13,9 cm	13,9 cm
NUMBER OF DOORS	2	2
NUMBER OF COMPARTMENTS AND VENTS	2	2
NUMBER OF MENU CLIPS	2	2
MENU CLIPS - LOCATION	1 per door	1 per door
HANDLES - TYPE AND LOCATION	Molded in, each end	Molded in, each end
CASTER TYPE	15,2 cm, 2 swivel w/brake, 2 rigid, offset	12,7 cm, 2 swivel w/brake, 2 rigid, offset
LATCHES	2 internal nylon friction	2 internal nylon friction
EXTERNAL DIMENSIONS W x D x H	140 x 96,5 x 110 cm	123,5 x 83 x 112 cm
INTERNAL DIMENSIONS W x D x H	53,5 x 77 x 70 cm	47 x 71,5 x 74 cm
UNIT WEIGHT	70,31 kg	71,5 kg

Case Pack: 1

Meal Delivery Carts For Tray Service (16 & 30 Tray Capacity)



Tall Profile

CODE	MDC1520T30	MDC1520T16	MDC1418T30	MDC1418T16
TRAY SIZE	38 x 51,5 cm	38 x 51,5 cm	36 x 46 cm	36 x 46 cm
TRAYS PER CART	30	16	30	16
TRAYS PER COMPARTMENT	10	8	10	8
RAILS PER COMPARTMENT	10	4	10	4
TRAYS PER RAIL	1	2	1	2
RAIL SPACING	12,7 cm	13,3 cm	12,7 cm	13,3 cm
NUMBER OF DOORS	3	1	3	1
NUMBER OF COMPARTMENTS	3	2	3	2
NUMBER OF MENU CLIPS	5	1	5	1
MENU CLIPS - LOCATION	Each door, each end	Back of cart	Each door, each end	Back of cart
HANDLES - TYPE AND LOCATION	Heavy-duty nylon, mounted 1 per end	Molded-in, 1 per end	Heavy-duty nylon, mounted 1 per end	Molded-in, 1 per end
CASTER TYPE	15,2 cm, 2 rigid, 4 swivel w/brake, offset	15,2 cm, 2 rigid, 2 swivel w/brake	15,2 cm, 2 rigid, 4 swivel w/brake, offset	15,2 cm, 2 rigid, 2 swivel w/brake
LATCHES	Friction catch, Transit latch*	Large paddle latch external security latches	Friction catch, Transit latch*	Large paddle latch
EXTERNAL DIMENSIONS W x D x H	152,5 x 74,5 x 162 cm	78 x 100 x 148 cm	152,5 x 74,5 x 162 cm	71,5 x 93 x 148 cm
INTERNAL DIMENSIONS W x D x H	39 x 53,34 x 127 cm	52,5 x 55 x 77,5 cm	37 x 55 x 127 cm	46,5 x 55 x 74,6 cm
REQUIRED DOOR WIDTH	77 cm	79 cm	77 cm	73 cm
UNIT WEIGHT	95,25 kg	62,37 kg	97,07 kg	63 kg

Case Pack: 1 **Colors** (All carts with Light Cream Door): Grey (180), Slate Blue (401), Granite Grey (191), Granite Green (192), Granite Sand (194).

*Stainless steel transit latch at top of each door. For lighter-duty applications, 30-tray carts may be ordered without the steel transit latches by using product code MDC1520T30NL or MDC1418T30NL.

Meal Delivery Carts Features and Caster Configurations

Standard Caster Configurations for Models:

MDC1520S20, MDC1418S20, MDC1411T60

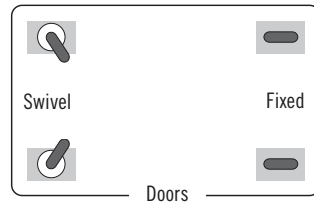

This configuration offers lead in casters to increase stability and maneuverability over uneven surfaces.

MDC1520S10, MDC1520T16, MDC1418T16

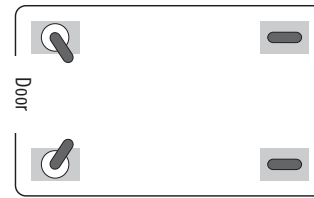

This configuration offers stability and makes the cart easy to maneuver.

MDC1520T30, MDC1418T30

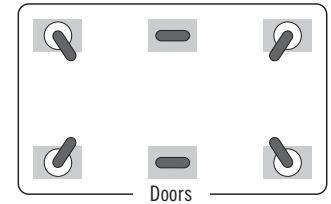

This configuration offers lead in casters to increase stability over uneven surfaces while providing a tighter turning radius.

Optional Caster Configurations for Models*:

*All optional caster configurations are special order items and therefore non-returnable.

MDC1520S20, MDC1418S20

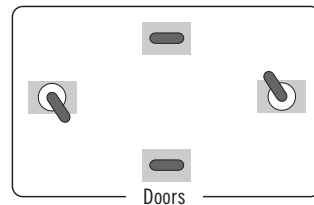

Diamond pattern configuration offers lead in casters and makes the cart highly maneuverable while providing a tighter turning radius.

MDC1520S20, MDC1418S20, MDC1520T30, MDC1418T30, MDC1411T60

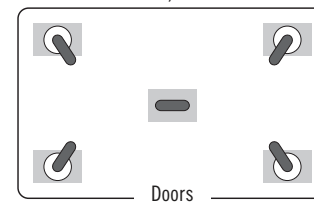

The 5-caster configuration offers lead in casters to ease movement over uneven surfaces while reinforcing linear motion.

MDC1520S20, MDC1418S20, MDC1411T60

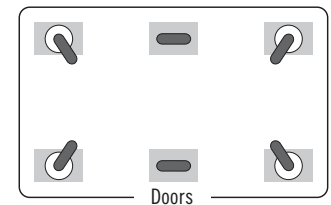

This configuration offers lead in casters to increase stability over uneven surfaces while providing a tighter turning radius.

Handles

MDC1520S20, MDC1418S20



Molded in handles on each end for smooth transporting.

MDC1520T16, MDC1418T16



Molded in handles for easy transporting.

MDC1520T30, MDC1418T30, MDC1411T60**



Heavy duty nylon handles are securely mounted and nested into each end.

**MDC1411T60 has tamper resistant heavy duty aluminum tubing handles.

LEAD IN CASTERS



Casters are offset to ease movement over uneven surfaces. This is standard on MDC1520S10, MDC1520S20, MDC1418S20, MDC1520T30, MDC1418T30 and MDC1411T60.

Meal Delivery Cart For Correctional Tray Service

Modified for use in correctional facilities. Holds 60 each 1411CW or 1411CP Cambro Base Trays with 853 Insert Trays or 60 each 10146DCW or 10146DCP Separator Compartment Trays. Security features include security screws on handles, stop locks on door knuckles, security bolts for transit latches and caster carriage bolts with lock nuts.



1411CP base tray with 853FH insert tray

CODE	MDC1411T60
TRAY SIZE	36,5 x 26,8 cm Base Tray 1411CW and 1411CP
TRAYS PER CART	60
TRAYS PER COMPARTMENT	20
RAILS PER COMPARTMENT	10
TRAYS PER RAIL	2
RAIL SPACING	12,7 cm
NUMBER OF COMPARTMENTS	3
MENU CLIPS	None
HANDLES - TYPE AND LOCATION	Heavy-duty aluminum with security screws, black finish, 1 per end
CASTER TYPE	15,2 cm heavy-duty casters, 5 cm wide tread, 2 swivel no brake, 2 rigid
LATCHES	Internal friction catch, 2 per door, transit latch***
EXTERNAL DIMENSIONS W x D x H	152,4 x 74,3 x 162 cm
INTERNAL DIMENSIONS W x D x H	37 x 55 x 127 cm
REQUIRED DOOR WIDTH	76,2 cm
UNIT WEIGHT KG	97,98 kg

Case Pack: 1

Colors: Grey (180), Slate Blue (401), Granite Grey (191), Granite Green (192), Granite Sand (194).

***Stainless steel transit latch at top of each door.

Alpha Numerical Listing

Discontinued items effective 1/1/2014

CODE	PAGE	CODE	PAGE	CODE	PAGE	CODE	PAGE
1000 (Group 1)	198	10HE2	65	12189CW	132	1418CL	203
1000 (Group 3)	198	10HPC	141	12189P	133	1418CT	204
1000CW	153	10HPCH	141	1218CCW	132	1418CW	219
1000LCD	9	10HPCHN	141	1218CP	133	1418D (Group 1)	203
1000LDCVVR	9	10HPD	139	1218DSCW	133	1418D (Group 3)	203
1005CW	153	10HS1114	58	1218MT	219	1418FF	213
1007CW	153	10HS318	58	1218SCCW	132	1418TR (Group 1)	198
100BC	45	10HS434	58	1219D (Group 1)	203	1418TR (Group 3)	198
100BC1	45	10HS638	58	1219D (Group 3)	203	1418TRCW	219
100BCS	45	10HS800	58	122 400 050	233	1418VC	202
100CW	151	10HS958	58	122 500 050	233	1418VC	231
100LCD	9,11	10PPCH	143	122 600 050	233	1418VCC	202,231
100MCCW	148	10PPCWSC	137	122 700 050	233	1418VDC	Discontinued
100MPC	13	10PPD	143	1220D (Group 1)	203	1422TR (Group 1)	198
100MPCHL	13	10PPSC	143	1220D (Group 3)	203	1422TR (Group 3)	198
100VS	152	10SC	Discontinued	1222D (Group 1)	203	14CW	135
1010VS	152	1100 (Group 1)	198	1222D (Group 3)	203	14HP	139
1012VS	152	1100 (Group 3)	198	1224MT	219	14PP	143
1013CW	153	1100CT	204	1230MT	219	150CW	151
1014 (Group 1)	197	1101CW	153	124VS	152	1520 (Group 1)	197
1014 (Group 3)	197	1111SMVS	152	1252SLB250	145	1520 (Group 3)	197
10145CW	216	1111SQVS	152	1252SLINB250	145	1520CBCP	76
10146CW	214	1116 (Group 1)	197	12CW	135	1520CBP	76
10146CW	216	1116 (Group 3)	197	12HP	139	1520CBPF	76
10146DCP	217	112 430 000	32,233	12HPH	140	1520CBR	76
10146DCPC	217	1120CBP	76	12RS12	45	1520CL	203
10146DCW	217	1120CBR	76	12SFSCW	124	1520CT	204
10146DCWC	217	116VS	152	12SFSP	125	1520CW	219
1014CL	203	1200 (Group 1)	198	12SFSPP	125	1520D (Group 1)	203
1014CT	204	1200 (Group 3)	198	12TGS	174	1520D (Group 3)	203
1014FF	213	1200CW	162	1300 (Group 1)	198	1520TR (Group 1)	198
1014VS	152	1200DIV	14,19	1300 (Group 3)	198	1520TR (Group 3)	198
1015 (Group 1)	197	1200P	161	1313 (Group 1)	199	1520VC	202,231
1015 (Group 3)	197	1200P2	161	1313 (Group 3)	199	1520VCC	202,231
1015MT	219	1202CW	153	1318 (Group 1)	197	1520VCRST	202,231
10302MT	219	120CWP	151	1318 (Group 3)	197	1520VDC	202,231
1030MT	219	120VS	152	1318MT	219	1525RST	209
103VS	152	1210PW	14,16,17,19	1318MTC	31	1550 (Group 1)	198
105VS	152	1212SQVS	152	13CLRWC	136	1550 (Group 3)	198
106VS	152	1216 (Group 1)	197	13CLRHP	140	1550CT	204
10CW	151	1216 (Group 3)	197	1400 (Group 1)	198	1596CP	215
10CWC	137	1216CL	203	1400 (Group 3)	198	1596CW	215
10CWCH	137	1216CT	204	1400CT	204	15CLRWC	136
10CWCHN	137	1216D (Group 1)	203	1400TL	205	15CLRHP	140
10CWD	135	1216D (Group 3)	203	14105CP	216	1600 (Group 1)	198
10CWGL	137,141	1216FF	213	14105CW	216	1600 (Group 3)	198
10CWL	151	1217FFH	213	1411CP	218	1600CT	204
10CWNR	151	12183CW	132	1411CW	218	1600CW	162
10HC258	59,64	12183P	133	1418 (Group 1)	197	1600DIV	14,19,41
10HC414	59	12186CW	132	1418 (Group 3)	197	1600P	161
10HE1	65	12186P	133	14187TRCW	216	1600P2	161

Alpha Numerical Listing

Discontinued items effective 1/1/2014

CODE	PAGE	CODE	PAGE	CODE	PAGE	CODE	PAGE
1600TL	205	182615P	133	20CWC	137	2436UTH	71
1621CBP	76	18263CW	132	20CWCH	137	2436UTHS	71
1621CBR	76	18263P	133	20CWCHN	137	24CW	135
1622 (Group 1)	197	18266CW	132	20CWD	135	24HP	139
1622 (Group 3)	197	18266P	133	20CWGL	137,141	24LPCW	135
16225 (Group 1)	197	18268CLRCW	133	20CWL	137	24LPHP	139
16225 (Group 3)	197	18268CLRKIT	133	20CWLN	137	24PP	143
1622CT	204	18269CW	132	20E2	65	2500 (Group 1)	198
1622D (Group 1)	203	18269P	133	20GE1	64	2500 (Group 3)	198
1622D (Group 3)	203	1826CCW	132	20GE2	65	2500CT	204
1622VC	Discontinued	1826CL	203	20HPC	141	250LCD	9
165PW	32,233	1826CLRCW	133	20HPCH	141	250LDCVVR	9
16C258	59,64	1826CP	133	20HPCHN	141	25CLRCW	136
16C414	59	1826CT	204	20HPD	139	25CLRHP	140
16C578	59	1826DBC	30	20HPL	141	25E1	64
16CW	135	1826DBCSP	30	20HPLN	141	25E2	65
16E1	64	1826DSCW	133	20LPCWC	137	25E4	65
16E2	65	1826DTC	30	20LPCWD	135	25E5	65
16E4	65	1826DTCSP	30	20LPHPC	141	25MCCW	148
16E5	65	1826HAR	17	20LPHPD	139	25S1058	56
16HP	139	1826LBC	31	20PPCH	143	25S1114	56
16PP	143	1826LBCSP	31	20PPCWSC	137	25S1214	56
16S1058	55	1826LTC	31	20PPD	143	25S318	56
16S1114	55	1826LTC3	31	20PPSC	143	25S418	56
16S1214	55	1826LTCSP	31	20S1114	56	25S434	56
16S318	55	1826MT	171,219	20S318	56	25S534	56
16S418	55	1826MTC	31	20S434	56	25S638	56
16S434	55	1826SCCW	132	20S638	56	25S738	56
16S534	55	1826STP	31	20S800	56	25S800	56
16S638	55	18CW	135	20S958	56	25S900	56
16S738	55	18PP	143	20SC	Discontinued	25S958	56
16S800	55	18SFSCW	124	21155CBP	76	25SWGf	60
16S900	55	18SFSP	125	21155CBR	76	2632 (Group 1)	199
16S958	55	18SFSP	125	21157CBP	76	2632 (Group 3)	199
1722CBCP	76	1950 (Group 1)	198	21157CBR	76	26CF	144
1722CBP	76	1950 (Group 3)	198	2115CBCP	76	26CW	135
1722CBR	76	1950CT	204	2115CBCR	76	26HP	139
17HE1	65	2000P	161	22CW	135	26PP	143
17HE2	65	2000P2	161	22HP	139	2700 (Group 1)	198
17HS1114	58	200BC	45	22LPCW	135	2700 (Group 3)	198
17HS318	58	200BC1	45	22LPHP	139	2700CT	204
17HS434	58	200BCS	45	22SFSCW	124	28CW	135
17HS638	58	200MCCW	148	22SFSP	125	28PP	143
17HS800	58	2025 (Group 1)	197	22SFSP	125	2900CT	204
17HS958	58	2025 (Group 3)	197	23CLRCW	136	29SFSCW	124
1800CT	204	2025MT	219	23CLRHP	140	29SFSP	125
1826 (Group 1)	197	2030UT	71	23SL	145	29SFSP	125
1826 (Group 3)	197	20C258	59,64	23SLB250	145	300DIV	14,16,19
182612CW	132	20C414	59	23SLB6250	145	300MPC	16
182612P	133	20CC	161	23SLINB250	145	3046 (Group 1)	199
182615CW	132	20CFC	144	240MPC	12	3046 (Group 3)	199

Alpha Numerical Listing

Discontinued items effective 1/1/2014

CODE	PAGE	CODE	PAGE	CODE	PAGE	CODE	PAGE
30CFC	144	36E1	64	49E1	64	63CLRHP	140
30CWC	137	36E2	65	49E2	65	64CW	135
30CWCH	137	36E4	65	49S1114	57	64HP	139
30CWCHN	137	36E5	65	49S318	57	64PP	143
30CWD	135	36HP	139	49S434	57	650WS	47
30CWGL	137,141	36PP	143	49S638	57	65CLRCW	136
30CWL	137	36S1058	57	49S800	57	65CLRHP	140
30CWLN	137	36S1114	57	49S958	57	65CWNR	151
30GE1	64	36S1214	57	4FBRTT	38	66CF	144
30GE2	65	36S318	57	4SFSCW	124	66CW	135
30HPC	141	36S418	57	4SFSP	125	66HP	139
30HPCH	141	36S434	57	4SFSP	125	66PP	143
30HPCHN	141	36S534	57	500CW	162	68VS	152
30HPD	139	36S638	57	500LCD	9	6F	170
30HPL	141	36S738	57	500LCDCVR	9	6FBRTT	38
30HPLN	141	36S800	57	500P	161	6RS6	45
30PPCH	143	36S900	57	500P2	161	6SFSCW	124
30PPCHN	143	36S958	57	50CW	151	6SFSP	125
30PPCWSC	137	3753 (Group 1)	199	50MCCW	148	6SFSP	125
30PPD	143	3753 (Group 3)	199	5412CBP	11	6TGS	174
30PPSC	143	3853 (Group 1)	199	5412CBP	45	725CWNR	151
30S1114	56	3853 (Group 3)	199	55CWNR	151	730SR	47
30S318	56	38CW	135	57 (Group 1)	197	730STP	44
30S434	56	400DIV	14,16,17,19	57 (Group 3)	197	730WS	47
30S638	56	400MCCW	148	5FBRTT	38	75CW	151
30S800	56	400STP	16,17,23	60CFC	144	800CW	162
30S958	56	40CWC	137	60CW	151	800P	161
30SC	Discontinued	40CWCH	137	60CWC	137	800P2	161
3200P2	161	40CWCHN	137	60CWCH	137	806CW	153
3242 (Group 1)	199	40CWD	135	60CWCHN	137	810 (Group 1)	197
3242 (Group 3)	199	40HPC	141	60CWD	135	810 (Group 3)	197
3253 (Group 1)	199	40HPCH	141	60CWGL	137,141	825CWNR	151
3253 (Group 3)	199	40HPCHN	141	60CWL	137	8262MT	219
3253CL	203	40HPD	139	60CWLN	137	826MT	219
3253CT	204	40PPCH	143	60HPC	141	8302MT	219
32CC	161	40PPCWSC	137	60HPCH	141	830MT	219
32CW	135	40PPD	143	60HPCHN	141	850CW	162
32HP	139	40PPSC	143	60HPD	139	853FCP	218
3343 (Group 1)	199	40SC	Discontinued	60HPL	141	853FCPC	218
3343 (Group 3)	199	415CBP	76	60HPLN	141	853FCW	218
33CLRCW	136	42CW	135	60PPCH	143	853FCWC	218
33CLRHP	140	42HP	139	60PPCHN	143	853FH	218
34CW	135	44CW	135	60PPCWSC	137	853FHC	218
34HP	139	44HP	139	60PPD	143	85SFVS	152
34PP	143	44PP	143	60PPSC	143	86VS	152
350LCD	9	45CW	151	60SC	Discontinued	8F	170
35CLRCW	136	46 (Group 1)	197	62CW	135	8FB434	62
35CLRHP	140	46 (Group 3)	197	62HP	139	8FBNH434	62
35CW	151	46CW	135	6302MT	219	8HC258	59,64
36CF	144	46HP	139	630MT	219	8HC414	59
36CW	135	46PP	143	63CLRCW	136	8HE1	65

Alpha Numerical Listing

Discontinued items effective 1/1/2014

CODE	PAGE	CODE	PAGE	CODE	PAGE	CODE	PAGE
8HE2	65	92615MT	219	BAR650PMT	50	CA2028	211
8HS1114	58	926MT	219	BAR650PMT220	50	CA2129	210
8HS318	58	92CW	135	BAR730	49	CA2632	211
8HS434	58	92HP	139	BAR730CP	49	CA2738	211
8HS638	58	93CW	151	BAR730DS	49	CA2836	211
8HS800	58	94CW	135	BAR730DSCP	49	CA3200	211
8HS958	58	94HP	139	BAR730SDX	48	CA3244	211
8RS8	45	94PP	143	BAR730DSPM	48	CA3247TR	211
8SFSCW	124	950CW	162	BAR730DSPMT	48	CA3253	211
8SFSP	125	950P	161	BAR730DSPMT2	48	CA3343	211
8SFSP	125	950P2	161	BAR730DX	48	CA3446	211
900 (Group 1)	198	95VS	152	BAR730PM	48	CA3646	211
900 (Group 3)	198	96CW	151	BAR730PMT	48	CA3748	211
900CT	204	96SKRC	175	BAR730PMT220	48	CA3753	211
900CW	153	96SKRD	175	BBR480	38	CA3800	211
900P	161	96SKRF	175	BBR720	38	CA3952	211
900P2	161	96SKRLC	175	BC1115SH	78	CA4064H	210
9011CW	153	96SKRLD	175	BC11TC	78	CA4300	211
9013CW	153	96SKRLF	175	BC225	78	CA4361	211
901CW	153	96SKRLM	175	BC2254S	78	CB1220	29,41,42,44
905CW	153	96SKRLP	175	BC230	78	CBA183672	115
909CW	153	96SKRM	175	BC2304S	78	CBA184272	115
90CWC	137	96SKRP	175	BC235	78	CBA184872	115
90CWCN	137	978SFVS	152	BC2354S	78	CBA213672	115
90CWD	135	99SMVS	152	BC330	78	CBA214272	115
90HPC	141	99VS	152	BC3304S	78	CBA214872	115
90HPD	139	9CWNR	151	BC331KD	77	CBA243672	115
90PPC	143	9E1	64	BC331KDSH	77	CBA244272	115
90PPCWSC	137	9E2	65	BC331KDTC	77	CBA244872	115
90PPD	143	9RS9	45	BC340KD	77	CBCC	115
90PPSC	143	9S1114	55	BC340KDP	77	CBDS18	115
90SC	Discontinued	9S318	55	BCT1014	214	CBDS21	115
90SPCW	151	9S434	55	BK60406	30	CBDS24	115
9113CP	217	9S638	55	BK60407	30	CBID6	115
9113CW	217	9S800	55	BR258	61,64	CBPK1864	114
9114CP	217	9S958	55	BR414	61	CBPK1872	114
9114CW	217	9TGS	174	BR578	61	CBPK1884	114
911CPC	217	ADCS	73	BR712	61	CBPK2164	114
911CWC	217	BAR540	51	BSB10	170	CBPK2172	114
911VS	152	BAR540DS	51	BSB12	170	CBPK2184	114
912CBP	76	BAR54SR	47	BSB18	170	CBPK2464	114
913MT	219	BAR650	51	BUF48	38	CBPK2472	114
913VS	152	BAR650CP	51	BUF72	38	CBPK2484	114
915 (Group 1)	197	BAR650DS	51	BV6CW	164	CBSK1830V	114
915 (Group 3)	197	BAR650DSCP	51	BWB16CW	156	CBSK1836V	114
915CP	215	BAR650SDX	50	BWM10CW	156	CBSK1842V	114
915CW	215	BAR650SPM	50	BWP14CW	156	CBSK1848V	114
918MT	219	BAR650SPMT	50	BWW10CW	156	CBSK1854V	114
91VS	152	BAR650SPMT2	50	CA1300	211	CBSK1860V	114
926 (Group 1)	197	BAR650DX	50	CA1623	210	CBSK2130V	114
926 (Group 3)	197	BAR650PM	50	CA2026	210	CBSK2136V	114

Alpha Numerical Listing

Discontinued items effective 1/1/2014

CODE	PAGE	CODE	PAGE	CODE	PAGE	CODE	PAGE
CBSK2142V	114	CDR2020	60,69	CMBPLHHD	27	CRPG12910	66
CBSK2148V	114	CDR2020H	60,69	CMBPLHSP	27	CRPG12911	66
CBSK2154V	114	CFFPRC10	144	CMBPLHSPHD	27	CRPG141012	66
CBSK2160V	114	CFPMRC10	144	CMBPLSP	25	CRPG181112	66
CBSK2430V	114	CFPSRC10	144	CMBPLSPHD	25	CRPG191011	66
CBSK2436V	114	CFR18	144	CMBPR1	27	CRPG2046	66
CBSK2442V	114	CFRC18	144	CMBPR7	27	CRPG20910	66
CBSK2448V	114	CFRSC18	144	CMBPSP	25	CRPG2878	66
CBSK2454V	114	CHPEL80	Discontinued	CMBPSPHD	25	CRPG3067	66
CBSK2460V	114	CJ80CW	175	CMBPTH	27	CRPG4467	66
CBU183672	115	CL900P	158,227	CMBPTH2	27	CRPG4856	66
CBU184272	115	CL950P	158,227	CMBPTH2HD	27	CRPG6345	66
CBU184872	115	CLJ6	158,227	CMBPTHHD	27	CRPG9911	66
CBU185472	115	CLLT10	158,227	CMBPTHSP	27	CRPH161317	63
CBU186072	115	CLLT12	158,227	CMBPTHSPHD	27	CRPHDG2878	61
CBU213672	115	CLLT6	158,227	CMBR	29	CRPHG1656	66
CBU214272	115	CLLT8	158	CMR7	25	CS1424SK	86
CBU214872	115	CLNT10	158,227	CO2632	208	CS1424VK	86
CBU215472	115	CLNT12	158,227	CO3200	208	CS1430SK	86
CBU216072	115	CLNT5	158,227	CO3253	208	CS1430VK	86
CBU243672	115	CLNT8	158,227	CO3343	208	CS1436SK	86
CBU244272	115	CLRSB16	225	CO3646	208	CS1436VK	86
CBU244872	115	CLRSB9	225	CO3753	208	CS1442SK	86
CBU245472	115	CLRSM8B5	225	CO3800	208	CS1442VK	86
CBU246072	115	CLRWSR36	225	CO4300	208	CS1448SK	86
CC32	147	CLSB16	227	CP12	172	CS1448VK	86
CCP12	172	CLSB9	227	CP1210	14	CS1454SK	86
CCP15	172	CLSM8B5	227	CP1220	11,14,17,19,41,44	CS1454VK	86
CCP27	172	CLSRB5	163,227	CP15	172	CS1460SK	86
CCPL12	172	CLSSM8B5	227	CP27	172	CS1460VK	86
CCPL27	172	CMB1826L	Discontinued	CP6040	30	CS1472SK	86
CD100	70	CMB1826LSP	Discontinued	CP814	14	CS1472VK	86
CD100H	70	CMBH1826LC	29	CP814	41	CS1824SK	86
CD100HB	70	CMBH1826TBC	29	CPB1220	37	CS1824VK	86
CD1313	71	CMBH1826TSC	29	CPH3	37	CS1830SK	86
CD1327	71	CMBHC1826LC	29	CPL12	172	CS1830VK	86
CD1420	71	CMBHC1826TBC	29	CPL27	172	CS1836SK	86
CD160	70	CMBHC1826TSC	29	CR12	72	CS1836VK	86
CD1826H	69	CMBP	25	CRP122327	63	CS1842SK	86
CD1826HB	69	CMBPH	27	CRP122328	63	CS1842VK	86
CD1826MTC	31,70	CMBPH2	27	CRP142732	63	CS1848SK	86
CD1826MTCHB	31,70	CMBPH2HD	27	CRP182832	63	CS1848VK	86
CD1826PDB	146	CMBPHD	25	CRP192528	63	CS1854SK	86
CD2020	69	CMBPHHD	27	CRP201015	63	CS1854VK	86
CD2020H	69	CMBPHSP	27	CRP202326	63	CS1860SK	86
CD2020HB	69	CMBPHSPHD	27	CRP281822	63	CS1860VK	86
CD2028	71	CMBPL	25	CRP301519	63	CS1872SK	86
CD300	16,30,31,70	CMBPLH	27	CRP441518	63	CS1872VK	86
CD300H	70	CMBPLH2	27	CRP481315	63	CS2124SK	86
CD300HB	70	CMBPLH2HD	27	CRP631013	63	CS2124VK	86
CD400	16,17,23,70	CMBPLHD	25	CRP92328	63	CS2130SK	86

Alpha Numerical Listing

Discontinued items effective 1/1/2014

CODE	PAGE	CODE	PAGE	CODE	PAGE	CODE	PAGE
CS2130VK	86	CSA48426	87	CSDDCPKG480	226	CSPK2164	86
CS2136SK	86	CSA48427	87	CSDR7	96,226	CSPK2172	86
CS2136VK	86	CSA48486	87	CSDR73	96,226	CSPK2184	86
CS2142SK	86	CSA48487	87	CSDRC244875PKG	96,226	CSPK2432	86
CS2142VK	86	CSA48546	87	CSDRC246075PKG	96,226	CSPK2456	86
CS2148SK	86	CSA48547	87	CSDS14	89	CSPK2464	86
CS2148VK	86	CSA48606	87	CSDS18	89	CSPK2472	86
CS2154SK	86	CSA48607	87	CSDS21	89	CSPK2484	86
CS2154VK	86	CSA51366	88	CSDS24	89	CSPRK1835	90
CS2160SK	86	CSA51367	88	CSEQ3	87,89,101	CSPRK1859	90
CS2160VK	86	CSA51426	88	CSFE14	90	CSPRK1867	90
CS2172SK	86	CSA51427	88	CSFE18	90	CSPRK1875	90
CS2172VK	86	CSA51486	88	CSFE21	90	CSPRK2135	90
CS2424SK	86	CSA51487	88	CSFE24	90	CSPRK2159	90
CS2424VK	86	CSA51546	88	CSFT241	90	CSPRK2167	90
CS2430SK	86	CSA51547	88	CSFT242	90	CSPRK2175	90
CS2430VK	86	CSA51606	88	CSFT301	90	CSPRK2435	90
CS2436SK	86	CSA51607	88	CSFT302	90	CSPRK2459	90
CS2436VK	86	CSA54366	88	CSFT361	90	CSPRK2467	90
CS2442SK	86	CSA54367	88	CSFT362	90	CSPRK2475	90
CS2442VK	86	CSA54368PKG	89	CSFT421	90	CSR3	9
CS2448SK	86	CSA54426	88	CSFT422	90	CSR5	9
CS2448VK	86	CSA54427	88	CSFT481	90	CSRDB	90
CS2454SK	86	CSA54428PKG	89	CSFT482	90	CSSB	90
CS2454VK	86	CSA54486	88	CSFT541	90	CSSC2448	94
CS2460SK	86	CSA54487	88	CSFT542	90	CSSU2448	94
CS2460VK	86	CSA54488PKG	89	CSFT601	90	CSSU244864PKG480	94
CS2472SK	86	CSA54546	88	CSFT602	90	CSSUM244867PKG480	94
CS2472VK	86	CSA54547	88	CSFT721	90	CSTSR	95
CSA41366	88	CSA54548PKG	89	CSFT722	90	CSU41366	87
CSA41367	88	CSA54606	88	CSHDC	93	CSU41367	87
CSA41426	88	CSA54607	88	CSHDDB	93,108	CSU41426	87
CSA41427	88	CSA54608PKG	89	CSHDFF	93	CSU41427	87
CSA41486	88	CSA58366	87	CSHDTK10	93	CSU41486	87
CSA41487	88	CSA58367	87	CSHDTK12	93	CSU41487	87
CSA41546	88	CSA58426	87	CSHDTK145	93	CSU41546	87
CSA41547	88	CSA58427	87	CSID	87,89,101	CSU41547	87
CSA41606	88	CSA58486	87	CSID3	87,89,101	CSU41606	87
CSA41607	88	CSA58487	87	CSPDC5	226	CSU41607	87
CSA44366	88	CSA58546	87	CSPK1432	86	CSU44366	88
CSA44367	88	CSA58547	87	CSPK1456	86	CSU44367	88
CSA44426	88	CSA58606	87	CSPK1464	86	CSU44426	88
CSA44427	88	CSA58607	87	CSPK1472	86	CSU44427	88
CSA44486	88	CSCC	89	CSPK1484	86	CSU44486	88
CSA44487	88	CSCR	90	CSPK1832	86	CSU44487	88
CSA44546	88	CSCS	90	CSPK1856	86	CSU44546	88
CSA44547	88	CSCSL	90	CSPK1864	86	CSU44547	88
CSA44606	88	CSCTL	90	CSPK1872	86	CSU44606	88
CSA44607	88	CSDBA	95	CSPK1884	86	CSU44607	88
CSA48366	87	CSDBS	95	CSPK2132	86	CSU48366	87
CSA48367	87	CSDC	226	CSPK2156	86	CSU48367	87

Alpha Numerical Listing

Discontinued items effective 1/1/2014

CODE	PAGE	CODE	PAGE	CODE	PAGE	CODE	PAGE
CSU48426	87	CSUR41366	91	CSURS48427	91	DCS1125	75
CSU48427	87	CSUR41367	91	CSURS48486	91	DCS950	75
CSU48486	87	CSUR41426	91	CSURS48487	91	DD1220BECW	171
CSU48487	87	CSUR41427	91	CSURS51366	91	DD1220CW	171
CSU48546	87	CSUR41486	91	CSURS51367	91	DD1220ECW	171
CSU48547	87	CSUR41487	91	CSURS51426	91	DD1220SCW	171
CSU48606	87	CSUR44366	91	CSURS51427	91	DD1826CW	171
CSU48607	87	CSUR44367	91	CSURS51486	91	DG3CW	156
CSU51366	87	CSUR44426	91	CSURS51487	91	DIV12	13,37,44
CSU51367	87	CSUR44427	91	CSURS54366	91	DIV20	13,37
CSU51426	87	CSUR44486	91	CSURS54367	91	DP15	166
CSU51427	87	CSUR44487	91	CSURS54426	91	DRC2020	60,225
CSU51486	87	CSUR48366	91	CSURS54427	91	DRLNK	117
CSU51487	87	CSUR48367	91	CSURS54486	91	DRS30	117
CSU51546	87	CSUR48426	91	CSURS54487	91	DRS300	117
CSU51547	87	CSUR48427	91	CSURS58366	91	DRS36	117
CSU51606	87	CSUR48486	91	CSURS58367	91	DRS360	117
CSU51607	87	CSUR48487	91	CSURS58426	91	DRS48	117
CSU54366	88	CSUR51366	91	CSURS58427	91	DRS480	117
CSU54367	88	CSUR51367	91	CSURS58486	91	DRS60	117
CSU54368PKG	89	CSUR51426	91	CSURS58487	91	DRS600	117
CSU54426	88	CSUR51427	91	CSWF	87,89,101	DSPR6	163
CSU54427	88	CSUR51486	91	CSWS1436SK	109	DT1220CW	171
CSU54428PKG	89	CSUR51487	91	CSWS1436VK	109	E3	65
CSU54486	88	CSUR54366	91	CSWS1448SK	109	EA183664	105
CSU54487	88	CSUR54367	91	CSWS1448VK	109	EA183672	105
CSU54488PKG	89	CSUR54426	91	CSWS1836SK	109	EA184264	105
CSU54546	88	CSUR54427	91	CSWS1848SK	109	EA184272	105
CSU54547	88	CSUR54486	91	CSWS36EK	109	EA184864	105
CSU54548PKG	89	CSUR54487	91	CSWS48EK	109	EA184872	105
CSU54606	88	CSUR58366	91	CVC55	43	EA185464	105
CSU54607	88	CSUR58367	91	CVC72	43	EA185472	105
CSU54608PKG	89	CSUR58426	91	CVC724	43	EA186064	105
CSU58366	87	CSUR58427	91	D12	160	EA186072	105
CSU58367	87	CSUR58486	91	D14	160	EA213664	105
CSU58426	87	CSUR58487	91	D16	160	EA213672	105
CSU58427	87	CSURS41366	91	D24	160	EA214264	105
CSU58486	87	CSURS41367	91	D8	160	EA214272	105
CSU58487	87	CSURS41426	91	DB18263CW	146	EA214864	105
CSU58546	87	CSURS41427	91	DB18263P	146	EA214872	105
CSU58547	87	CSURS41486	91	DB18266CW	146	EA215464	105
CSU58606	87	CSURS41487	91	DBC1826CW	146	EA215472	105
CSU58607	87	CSURS44366	91	DBC1826P	146	EA216064	105
CSUHD44367	93	CSURS44367	91	DC10	166	EA216072	105
CSUHD44367S	93	CSURS44426	91	DC1225	75	EA243664	105
CSUHD44427	93	CSURS44427	91	DC5	166	EA243672	105
CSUHD44427S	93	CSURS44486	91	DC575	75	EA243684PKG	105
CSUHD44486	93	CSURS44487	91	DC700	75	EA244264	105
CSUHD44486S	93	CSURS48366	91	DC825	75	EA244272	105
CSUHD44487	93	CSURS48367	91	DCC10	166	EA244284PKG	105
CSUHD44487S	93	CSURS48426	91	DCC5	166	EA244864	105

Alpha Numerical Listing

Discontinued items effective 1/1/2014

CODE	PAGE	CODE	PAGE	CODE	PAGE	CODE	PAGE
EA244872	105	EMSK2448S	106	EPK2464	101	ESK2142V	103
EA244884PKG	105	EMSK2448V	106	EPK2472	101	ESK2148S	103
EA245464	105	EMSK2454S	106	EPK2484	101	ESK2148V	103
EA245472	105	EMSK2454V	106	ES28	42	ESK2154S	103
EA245484PKG	105	EMSK2460S	106	ES28RL	42	ESK2154V	103
EA246064	105	EMSK2460V	106	ESK1424S	103	ESK2160S	103
EA246072	105	EMU183670	107	ESK1424V	103	ESK2160V	103
EA246084PKG	105	EMU183670P	107	ESK1430S	103	ESK2172S	103
ECC	101	EMU183678	107	ESK1430V	103	ESK2172V	103
EDBA	108	EMU183678P	107	ESK1436S	103	ESK2178S	103
EDBS	108	EMU184270	107	ESK1436V	103	ESK2178V	103
EDRC244878PKG	96	EMU184270P	107	ESK1442S	103	ESK2424S	103
EDRC246078PKG	96	EMU184278	107	ESK1442V	103	ESK2424V	103
EDS14	101	EMU184278P	107	ESK1448S	103	ESK2430S	103
EDS18	101	EMU184870	107	ESK1448V	103	ESK2430V	103
EDS21	101	EMU184870P	107	ESK1454S	103	ESK2436S	103
EDS24	101	EMU184878	107	ESK1454V	103	ESK2436V	103
EMPK1870	106	EMU184878P	107	ESK1460S	103	ESK2436V4	103
EMPK1878	106	EMU213670	107	ESK1460V	103	ESK2442S	103
EMPK2170	106	EMU213670P	107	ESK1472S	103	ESK2442V	103
EMPK2178	106	EMU213678	107	ESK1472V	103	ESK2448S	103
EMPK2470	106	EMU213678P	107	ESK1478S	103	ESK2448V	103
EMPK2478	106	EMU214270	107	ESK1478V	103	ESK2448V4	103
EMSC	108	EMU214270P	107	ESK1824S	103	ESK2454S	103
EMSCB	108	EMU214278	107	ESK1824V	103	ESK2454V	103
EMSCBP	108	EMU214278P	107	ESK1830S	103	ESK2460S	103
EMSCP	108	EMU214870	107	ESK1830V	103	ESK2460V	103
EMSK1836S	106	EMU214870P	107	ESK1836S	103	ESK2460V4	103
EMSK1836V	106	EMU214878	107	ESK1836V	103	ESK2472S	103
EMSK1842S	106	EMU214878P	107	ESK1836V4	103	ESK2472V	103
EMSK1842V	106	EMU243670	107	ESK1842S	103	ESK2478S	103
EMSK1848S	106	EMU243670P	107	ESK1842V	103	ESK2478V	103
EMSK1848V	106	EMU243678	107	ESK1848S	103	ESU183664	104
EMSK1854S	106	EMU243678P	107	ESK1848V	103	ESU183672	104
EMSK1854V	106	EMU244270	107	ESK1848V4	103	ESU184264	104
EMSK1860S	106	EMU244270P	107	ESK1854S	103	ESU184272	104
EMSK1860V	106	EMU244278	107	ESK1854V	103	ESU184864	104
EMSK2136S	106	EMU244278P	107	ESK1860S	103	ESU184872	104
EMSK2136V	106	EMU244870	107	ESK1860V	103	ESU185464	104
EMSK2142S	106	EMU244870P	107	ESK1860V4	103	ESU185472	104
EMSK2142V	106	EMU244878	107	ESK1872S	103	ESU186064	104
EMSK2148S	106	EMU244878P	107	ESK1872V	103	ESU186072	104
EMSK2148V	106	EPK1464	101	ESK1878S	103	ESU213664	104
EMSK2154S	106	EPK1472	101	ESK1878V	103	ESU213672	104
EMSK2154V	106	EPK1484	101	ESK2124S	103	ESU214264	104
EMSK2160S	106	EPK1864	101	ESK2124V	103	ESU214272	104
EMSK2160V	106	EPK1872	101	ESK2130S	103	ESU214864	104
EMSK2436S	106	EPK1884	101	ESK2130V	103	ESU214872	104
EMSK2436V	106	EPK2164	101	ESK2136S	103	ESU215464	104
EMSK2442S	106	EPK2172	101	ESK2136V	103	ESU215472	104
EMSK2442V	106	EPK2184	101	ESK2142S	103	ESU216064	104

Alpha Numerical Listing

Discontinued items effective 1/1/2014

CODE	PAGE	CODE	PAGE	CODE	PAGE	CODE	PAGE
ESU216072	104	GP3074 (Group 1)	189	IBS20	147	MA3800	212
ESU243664	104	GP3788	189	IBS27	147	MA4300	212
ESU243672	104	GP3980 (Group 1)	190	IBS37	147	MA4361	212
ESU243684PKG	104	GP3980 (Group 3)	189	IBSF27	147	MDC1411T60	237
ESU244264	104	GP3980 (Group 8)	186	ICS100L	52	MDC1418S20	235
ESU244272	104	GP3980AB	187,228	ICS100L4S	52	MDC1418T16	236
ESU244284PKG	104	GP3980NS (Group 3)	191,229	ICS125L	52	MDC1418T30	236
ESU244864	104	GP4002 (Group 1)	190	ICS125LB	52	MDC1520S10	234
ESU244872	104	GP4002 (Group 3)	189	ICS125T	52	MDC1520S10HD	234
ESU244884PKG	104	GP4002 (Group 8)	186	ICS175L	52	MDC1520S20	235
ESU245464	104	GP4002AB	187,228	ICS175LB	52	MDC1520T16	236
ESU245472	104	GP4002NS (Group 3)	191,229	ICS175T	52	MDC1520T30	236
ESU245484PKG	104	GP4004 (Group 1)	190	ICS175TB	52	MDC24	11
ESU246064	104	GP4004 (Group 3)	189	ICS200TB	52	MDC24F	11
ESU246072	104	GP4210 (Group 1)	189	IT3253	32,233	MDC24R	11
ESU246084PKG	104	GP4410	189	IT3753	32,233	MDSB16	225
FPID24	142	GP4701 (Group 1)	189	ITPD3253	32,233	MDSB5	225
FR258	62	GP4709 (Group 1)	189	ITPD3753	32,233	MDSB9	225
FSG480	38	GP4853 (Group 1)	189	KK1200	59	MDS9	224
FSG720	38	GP4856 (Group 1)	189	KMC24	41	MDSDCPKG480	226
FWC56	62,72	GP55653 (Group 1)	189	KSC402	42	MDSL9	224
GB1200CW	156	GP55702 (Group 1)	189	KSC402220	42	MDSL9	224
GB850CW	156	GP55703 (Group 1)	189	KVC854	41	MDSM8	225
GK2000	59	GPE0540	185	KVC854C	41	MDSP9	224
GL0540 (Group 1)	192	GPE3980	185	KVC854U	41	MDSPL	225
GL1070 (Group 1)	192	GPE4002	185	KVC856	41	MDSPL9	224
GL1070RNS	196	GPE4004	185	KVC856C	41	MW2129	207
GL1080 (Group 1)	192	HBR258	61,64	KVC856U	41	MW3200	207
GL210P (Group 1)	193	HBR414	61	KWS40	42	MW3245	207
GL220P (Group 1)	193	HBR578	61	LCDC	10	MW3600	207
GL3074 (Group 1)	192	HBR712	61	LCDC10	10	MW3646	207
GL3788	192	HE3	65	LCDES	10	MW3858	207
GL3980 (Group 1)	192	HFR258	62	LD105	172	MW4200	207
GL3980NS (Group 1)	195,230	HK39	151	LD105A	172	MY2026	209
GL3980RNS	196	HK39B	224	LD130	172	MY2129	209
GL4002 (Group 1)	192	HK93BCW	151	LD85	172	MY2632	209
GL4002NS (Group 1)	195,196,230	HK93CW	151	LD85A	172	MY2738	209
GL4060 (Group 1)	192	HT10CW	159	LED54LIGHTPKG	37	MY3200	209
GL4210 (Group 1)	192	HT120CW	159	LT10	160	MY3244	209
GL4410	192	HT12CW	159	LT12	160	MY3253	209
GL4701 (Group 1)	192	HT14CW	159	LT14	160	MY3343	209
GL4709 (Group 1)	192	HT16CW	159	LT16	160	MY3446	209
GP0540 (Group 1)	190	HT22CW	159	LT22	160	MY3646	209
GP0540 (Group 3)	189	HT5CW	159	LT6	160	MY3753	209
GP0540NS (Group 3)	191,229	HT8CW	159	LT8	160	MY3800	209
GP1070 (Group 1)	189	HWAPR	10	MA2435	212	MY3952	209
GP1070 (Group 8)	186	HWATD	10	MA3142H	212	MY4300	209
GP1070AB	187,228	HYDRATIONPKG	10	MA3200	212	MY4361	209
GP1080 (Group 1)	189	IB32	147	MA3343	212	NT10	159
GP1080AB	187,228	IB36	147	MA3646	212	NT12	159
GP1080NS (Group 3)	191,229	IB44	147	MA3652TR	212	NT14	159

Alpha Numerical Listing

Discontinued items effective 1/1/2014

CODE	PAGE	CODE	PAGE	CODE	PAGE	CODE	PAGE
NT16	159	PR59500	62	RFSCW1	128	SPO13	173
NT20	159	PS1014	214	RFSCW12	128	SPO13CW	173
NT5	159	PSB10	168	RFSCW18	128	SPO8CW	173
NT8	159	PSB12	168	RFSCW2	128	SPOP10CW	173
NT9	159	PSB15	169	RFSCW22	128	SPOP11CW	173
OETR314	62	PSB18	169	RFSCW4	128	SPOP13	173
P320CW	155	PSB23	169	RFSCW6	128	SPOP13CW	173
P34CW	155	PSB6	168	RFSCW8	128	SRB13	163
P34LCW	155	PSB8	168	RFSCWC1	128	SRB13CW	163
P480CW	155	PT1014	205	RFSCWC12	128	SRB5	163
P600CW	155	PT1100	205	RFSCWC2	128	SRB5CW	163
P60CW	155	PT1216	205	RFSCWC6	128	TC1418	72
P64CW	155	PT1400	205	RSB1014CW	169	TDC2029	72
PC34CW	155	PT1418	205	RSB10CW	169	TDC30	75
PC64CW	155	PT1600	205	RSB12CW	169	TDCR12	72
PE600CW	155	PWB22	10,163	RSB1419CW	169	TG6	174
PH556010	206	R1000LCD	10	RSB15CW	169	TG9	174
PH556016	206	R500LCD	10	RSB18CW	169	TGA11	174
PH556020	206	RD1200CW	171	RSB23CW	169	TGA8	174
PH556026	206	RD1220CWH	171	RSB6CW	169	TGG6	174
PH556030	206	RD1826CW	171	RSB8CW	169	TGG9	174
PH556036	206	RD1826CWH	171	RSB912CW	169	UC1000	9
PH556040	206	RD926CW	171	SB55	170	UC1000CVR	9
PH556046	206	RFS1	129	SB60	170	UC250	9
PH556050	206	RFS12	129	SB80	170	UC250CVR	9
PH556056	206	RFS12PP	129	SBH15	37	UC500	9
PH556510	206	RFS12SCPP	128	SBH18	37	UC500CVR	9
PH556516	206	RFS18	129	SCP12CW	148	UPC100	13
PH556520	206	RFS18PP	129	SCP24CW	148	UPC101	Discontinued
PH556526	206	RFS1PP	129	SCP64CW	148	UPC1200	19
PH557010	206	RFS1SCPP	128	SCP6CW	148	UPC140	13
PH557016	206	RFS2	129	SFC12	125	UPC160	13
PH557020	206	RFS22	129	SFC12SCPP	124	UPC1600	19
PH557026	206	RFS22PP	129	SFC2	125	UPC1600HD	19
PH557030	206	RFS2PP	129	SFC2SCPP	124	UPC1600SP	19
PH557036	206	RFS2SCPP	128	SFC6	125	UPC180	13
PH557040	206	RFS4	129	SFC6SCPP	124	UPC400	16
PH557046	206	RFS4PP	129	SFG1012	167	UPC400SP	16
PH558510	206	RFS6	129	SFG1015	167	UPC600	19
PH558516	206	RFS6PP	129	SFG1220	167	UPC800	19
PH558520	206	RFS6SCPP	128	SFG820	167	UPC800SP	19
PH558526	206	RFS8	129	SFR1012	167	UPCGL1600SP	19
PH558530	206	RFS8PP	129	SFT1010	167	UPCH1600	23
PH558536	206	RFSC1	129	SFT1212	167	UPCH16002	23
PL60CW	155	RFSC12	129,163	SFT1515	167	UPCH16002HD	23
PPB15	164	RFSC12PP	129	SFV1015	167	UPCH16002SP	23
PPB18	164	RFSC1PP	129	SLL30	145	UPCH1600HD	23
PPB23	164	RFSC2	129	SPA14	173	UPCH1600SP	23
PR314	62	RFSC2PP	129	SPASL14	173	UPCH400	23
PR500	62	RFSC6	129	SPO10CW	173	UPCH4002	23
PR59314	62	RFSC6PP	129	SPO11CW	173	UPCH800	23

Alpha Numerical Listing

Discontinued items effective 1/1/2014

CODE	PAGE	CODE	PAGE	CODE	PAGE
UPCH8002	23	VCS	36	VT3753 (Group 1)	188
UPCHT1600	23	VCS32CNT	36	VT3753 (Group 8)	186
UPCHT16002	23	VCS32KEYT	37	VT3853 (Group 1)	188
UPCHT16002HD	23	VCS32R	37	VTE1418	185
UPCHT1600HD	23	VCSCNL	36	VTE3253	185
UPCHT800	23	VCSCVR	37	VTE3343	185
UPCHT8002	23	VCSHD	36	VTE3646C	185
UPCHW400	23	VCSWR	36	VTE3753	185
UPCHW4002	23	VCSWRHD	36	WC100CW	164
UPCS140	13	VL1014 (Group 1)	193	WC100CWNH	164
UPCS160	13	VL1216 (Group 1)	193	WCR1220	41,44
UPCS180	13	VL1418 (Group 1)	193	WCS30	164
UPCS400	17	VL1418 (Group 5)	194	WR60406	30
UPCS400CK	17	VL1418NS (Group 1)	195	WR60407	30
UPCSS160	13	VL1418NS (Group 1)	230	WW1000CW	162
UTHSTP	17	VL1418RNS	196	WW1000L	162
VBR5	36	VL1418TR	193	WW1000LS	162
VBR6	36	VL1520	193	WW1500CW	162
VBRC	36	VL2129RNS	196	WW250CW	162
VBRC90	36	VL2632 (Group 1)	193	WW250L	162
VBRCVR5	37	VL3200RNS	196	WW500CW	162
VBRCVR6	37	VL3253 (Group 1)	193		
VBRHD5	36	VL3343 (Group 1)	193		
VBRHD6	36	VL3343C (Group 1)	193		
VBRL5	36	VL3343CNS (Group 1)	195,230		
VBRL6	36	VL3343NS (Group 1)	195,230		
VBRLHD5	36	VL3600RNS	196		
VBRLHD6	36	VL3646C (Group 1)	193		
VBRR5	37	VL3646C (Group 5)	194		
VBRR6	37	VL3646CNS (Group 1)	195,230		
VBRSHTS	37	VL3753 (Group 1)	193		
VBRT5	36	VT1216 (Group 1)	188		
VBRT6	36	VT1418 (Group 1)	188		
VBRTBL	37	VT1418 (Group 5)	194		
VBRTCVR5	37	VT1418 (Group 8)	186		
VBRTCVR6	37	VT1418AB	187,228		
VBRTHD5	36	VT1418TR	188		
VBRTHD6	36	VT1520	188		
VBRTL5	36	VT2632 (Group 1)	188		
VBRTL6	36	VT2632 (Group 8)	186		
VBRTLHD5	36	VT3253 (Group 1)	188		
VBRTLHD6	36	VT3253 (Group 8)	186		
VBRU5	36	VT3343 (Group 1)	188		
VBRU6	36	VT3343 (Group 8)	186		
VBRUHD5	36	VT3343AB	187,228		
VBRUHD6	36	VT3343C (Group 1)	188		
VBRUT5	36	VT3343CAB	187,228		
VBRUT6	36	VT3646C (Group 1)	188		
VBRUTHD5	36	VT3646C (Group 5)	194		
VBRUTHD6	36	VT3646C (Group 8)	186		
VBRWC	37	VT3646CAB	187,228		

Stemware And Glass Sizing Reference Guide

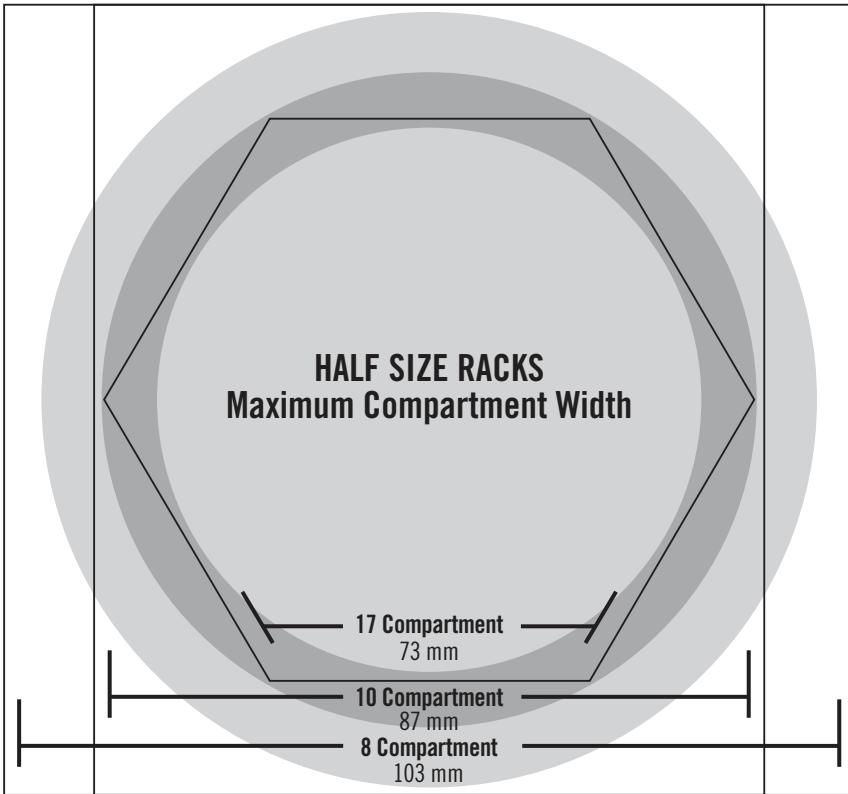

To Determine Compartment Size

- Half Size Racks:**
Place glass or stemware upside down over circle chart. Look down on the glass. Whatever circle the largest diameter of the glass fits within will determine the number of compartments.
- Full Size Racks:**
Place glass or stemware upside down over circle chart. Look down on the glass. Whatever circle the largest diameter of the glass fits within will determine the number of compartments.

Use the vertical guide marks at right to determine item height and appropriate rack number.

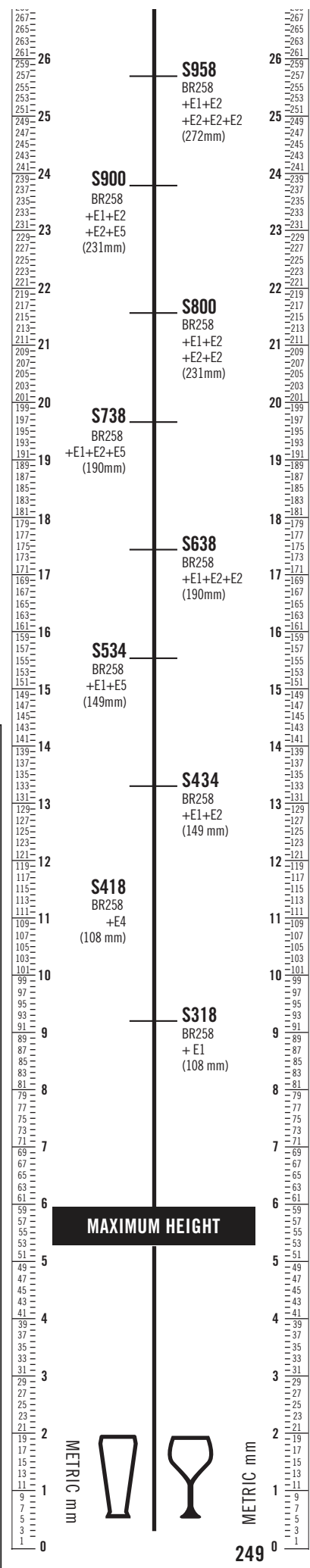
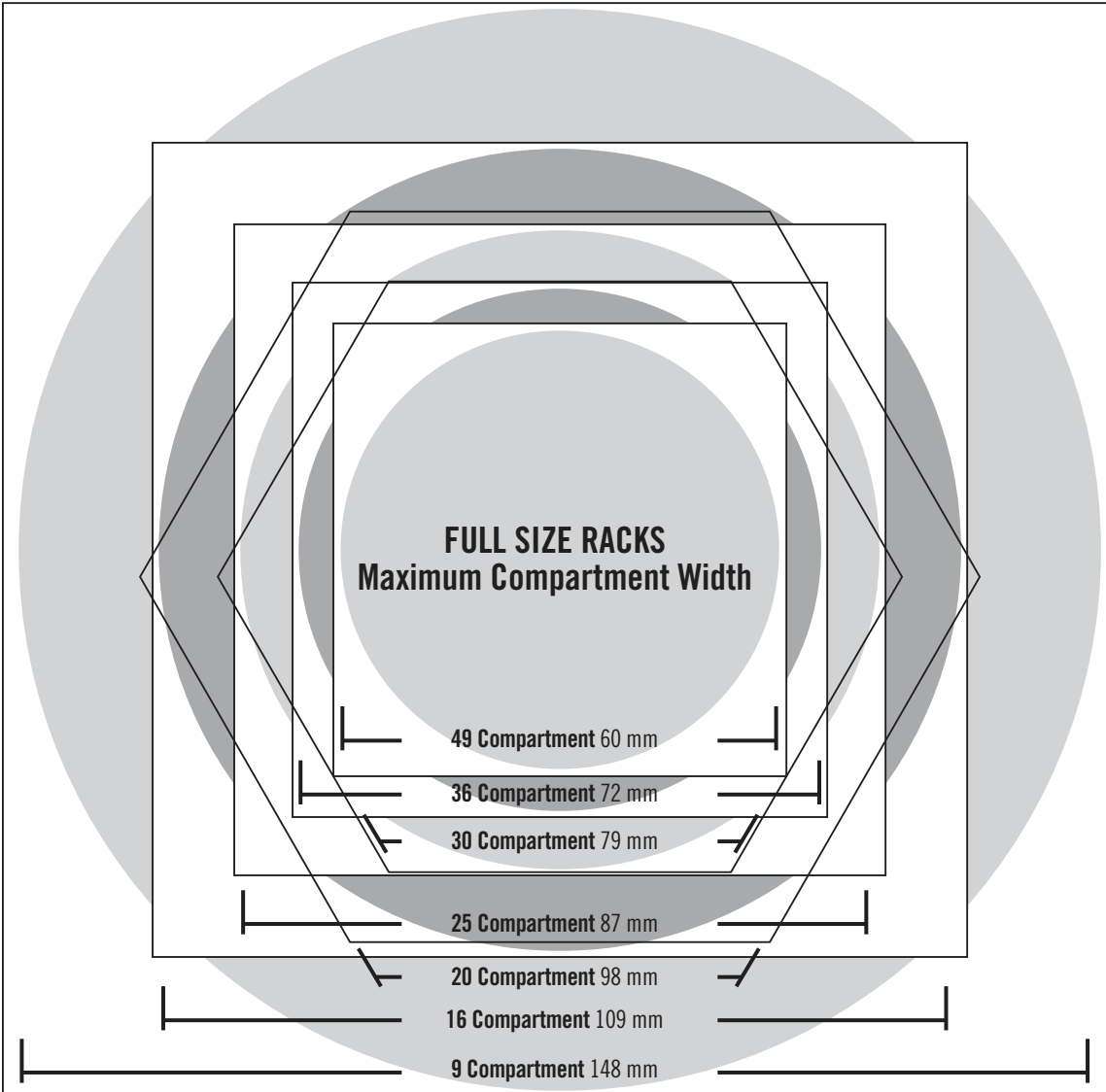

Camrack® Cup Rack Reference Guide



16

FULL RACK

COMPARTMENT
11,1 x 11,1 cm

QUICK GUIDE

Full Size Cup Racks (C)

Maximum Cup Width	Number of Compartments	Maximum Cup Height		
		6,6 cm	10,7 cm	14,9 cm
11,1 cm	16	16C258	16C414	16C578
8,8 cm	20	20C258	20C414	NA

To determine Cup compartment size:

Turn cup or coffee mug upside down and place diagonally in square. Align handle with arrow in square. Cup or mug and handle must fit completely within boundaries of a square in order to ensure the right rack.



20

FULL RACK

COMPARTMENT
11,1 x 8 cm



10

HALF RACK

COMPARTMENT
10,4 x 8,8 cm



8

HALF RACK

COMPARTMENT
11,3 x 10,4 cm

QUICK GUIDE

Full Size Cup Racks (C)

Maximum Cup Width	Number of Compartments	Maximum Cup Height	
		6,6 cm	10,7 cm
10,4 cm	8	8HC258	8HC414
8,8 cm	10	10HC258	10C414

To Determine Cup Height:

Place base of cup or coffee mug on flat surface hold ruler vertically next to it to determine height in inches or millimeters. If the height is greater than 108 mm, additional 41 mm E2 and HE2 extenders may be ordered.

Cambro® Equipment Color Chart



180

Gray



157

Coffee Beige



158

Hot Red

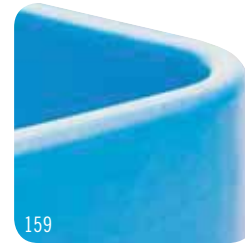

159

Cold Blue

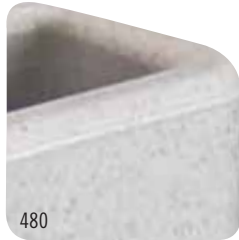

480

Speckled Gray



417

Dark Taupe



402

Brick Red

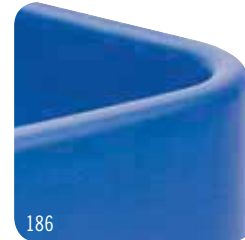

186

Navy Blue



614

Sandstone



194

Granite Sand

Cambro provides a wide selection of colors to help you coordinate with your decor and color code items to simplify use. Color selections vary by product. Please see individual products for specific colors offered.

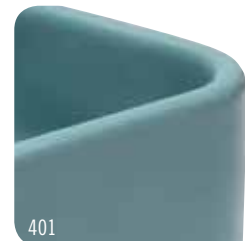

401

Slate Blue

Due to the printing process, the colors shown may not be exact. For exact colors, contact Cambro or a Cambro Sales Representative for a color chip.



191

Granite Gray



131

Dark Brown

Due to the catalog printing process, the colors shown may not be exact. For exact colors, contact Cambro or a Cambro representative for a color chip.



192

Granite Green



615

Charcoal Gray



146

Bronze



519

Kentucky Green

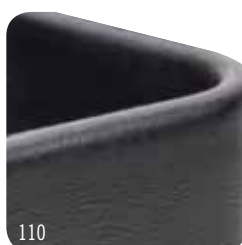

110

Black

For A Complete List of U.S.A. and International Representatives Please Visit www.cambro.com

ew from C [®]



Combo Cart™ Plus Electric Low
Page 24



Combo Cart™ Plus Non-Electric Low
Page 26



Camshelving® Full-wrap Security Cage
Page 95



Camshelving Drying System
Page 96, 226



Camshelving Elements Drying System
Page 96, 226



Camshelving® Basics Series
Page 110



Translucent Seal Cover for Polycarbonate food pans
Page 137



Low Profile 10-Tray Meal Delivery Cart
Page 234

COMCATER
-foodservice equipment
www.comcater.com.au

NATIONAL HEAD OFFICE
156 Swann Drive, Derrimut, VIC 3030
Phone: 03 8369 4600
Fax: 03 8369 4699
Email: sales@comcater.com.au

NATIONAL CUSTOMER SERVICE
Phone: 1800 035 327
Fax: 1800 808 954

CAMBRO
TRUSTED FOR GENERATIONS™

CAMBRO U.S.A.
5801 Skylab Road, Huntington Beach, CA 92647
P.O. Box 2000, Huntington Beach, CA 92647-2000
TEL: 1(714) 848-1555 FAX: 1(714) 843-2630
international@cambro.com

C.E.L.
TEL: (49) 7022 90 100 0
FAX: (49) 7022 90100 19
cambroeuropa@cambro.com

CAMBRO UK
TEL: 0800 587 0057 Toll Free
FAX: 0845 280 3411
cambrouk@cambro.com

IRELAND
TEL: 1800 509 046 Toll Free
FAX: 01 633 55 76
cambroireland@cambro.com

© Copyright Cambro Manufacturing Company. Printed in the U.S.A.
CAT2014/15METWLD

9001:2008
CERTIFIED



Cambro is a proud recipient of the U.S. President's E-Award for Excellence in Exporting.